

Features

- Ideal for 2.4 GHz Cordless Applications
- Power Set Pin for Adjustable Output Power
High Power Mode: 24 dBm, 300 mA
Low Power Mode: 16 dBm, 110 mA
- Power Gain: 23 dB Typical
- Power Enable: 2.5 V
- Micro-Amp Shutdown Current
- Operates from 1.8 V to 3.6 V
- Lead-Free 3 mm 12-Lead PQFN Package
- 100% Matte Tin Plating over Copper
- Halogen-Free "Green" Mold Compound
- RoHS* Compliant and 260°C Reflow Compatible

Description

The MAAPSS0081 is a three stage power amplifier designed for 2.4 GHz Cordless Telephone applications. The power amplifier is available in a lead-free 3 mm 12-lead PQFN plastic package. The MAAPSS0081 features an integrated power enable pin (5) for accurate ramp control and a separate power mode pin (2) for current savings in a low power mode state.

Ordering Information^{1,2}

Part Number	Package
MAAPSS0081TR-3000	3000 piece reel
MAAPSS0081SMB	Sample Board, 2.4 - 2.5 GHz tuning

1. Reference Application Note M513 for reel size information.
2. All sample boards include 5 loose parts.

Functional Schematic

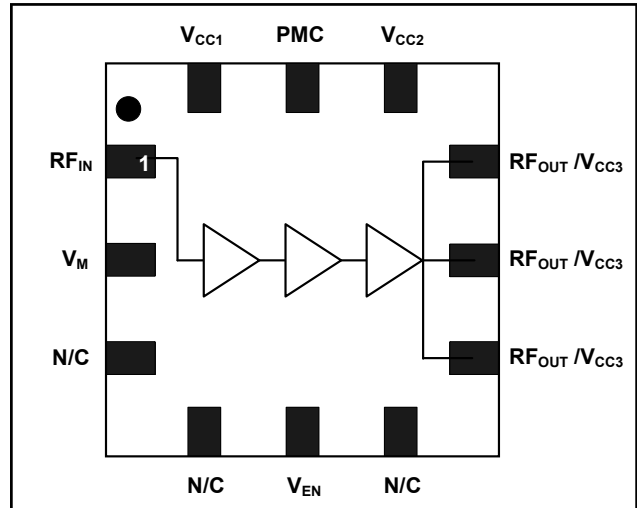

Pin Configuration

Pin No.	Pin Name	Description
1	RF _{IN}	RF Input
2	V _M	Power Mode
3	N/C	No Connection
4	N/C	No Connection
5	V _{EN}	Power Enable
6	N/C	No Connection
7	RF _{OUT} / V _{CC3}	RF Output, 3rd Stage Supply
8	RF _{OUT} / V _{CC3}	RF Output, 3rd Stage Supply
9	RF _{OUT} / V _{CC3}	RF Output, 3rd Stage Supply
10	V _{CC2}	2nd Stage Supply
11	PMC	Power Mode Control
12	V _{CC1}	1st Stage Supply
Pad ³	GND	RF & DC Ground

3. The exposed pad centered on the package bottom must be connected to RF and DC ground.

* Restrictions on Hazardous Substances, European Union Directive 2002/95/EC.

ISM Power Amplifier 2.4 - 2.5 GHz

Rev. V1

Electrical Specifications: $F = 2.45 \text{ GHz}$, $P_{IN} = 1 \text{ dBm}$, $V_{CC} = 2.4 \text{ V}$, $T_A = 25 \text{ }^\circ\text{C}$, $Z_0 = 50 \text{ } \Omega$

Parameter	Test Conditions	Units	Min.	Typ.	Max.
Input Return Loss	$V_M = 0 \text{ V}$	dB	—	10	—
	$V_M = 2.5 \text{ V}$	dB	—	20	—
P_{OUT} , High Power Mode (HPM)	$V_M = 2.5 \text{ V}$, $V_{CC} = 3.0 \text{ V}$	dBm	—	25	—
	$V_{CC} = 2.4 \text{ V}$	dBm	23	24	—
	$V_{CC} = 2.0 \text{ V}$	dBm	—	23	—
P_{OUT} vs. Temperature, HPM	$T_A = 0 \text{ }^\circ\text{C}$ to $50 \text{ }^\circ\text{C}$, $V_{CC} = 2.4 \text{ V}$	dB	—	0.8	—
Current, HPM	$V_M = 2.5 \text{ V}$, $V_{CC} = 2.4 \text{ V}$	mA	—	300	400
P_{OUT} , Low Power Mode (LPM)	$V_M = 0 \text{ V}$, $V_{CC} = 2.4 \text{ V}$	dBm	13	16	—
Current, LPM	$V_M = 0 \text{ V}$, $V_{CC} = 2.4 \text{ V}$	mA	—	110	200
Current, Shutdown	$V_{CC} = 2.4 \text{ V}$, $V_{EN} = 0 \text{ V}$	μA	—	1	—
Mode Current	$V_M = 2.5 \text{ V}$, $V_{CC} = 2.4 \text{ V}$	mA	—	0.5	—
Enable Current	$V_M = 2.5 \text{ V}$, $V_{CC} = 2.4 \text{ V}$, $V_{EN} = 2.5 \text{ V}$	mA	—	2.0	4.0
Harmonics	$V_M = 2.5 \text{ V}$, $V_{CC} = 2.4 \text{ V}$	$2f_o$	—	-37	—
		$3f_o$	—	-37	—
Forward Isolation	$V_{EN} = 0 \text{ V}$	dB		36	
Stability	$+1.5 \text{ V} < V_{CC} < +3.5 \text{ V}$, $P_{OUT} = \text{HPM \& LPM}$, $VSWR < 6:1$ $-20 \text{ }^\circ\text{C} < T_A < +70 \text{ }^\circ\text{C}$, $RBW = 3 \text{ MHz max. hold}$		All spurs $< -60 \text{ dBc}$		
Turn on/off time	t_{on} : RF burst to (Avg Power – 1 dB)	μS	—	5	—
	t_{off} : (Avg Power – 1 dB) to RF off	μS	—	5	—
Power Gain		dB	—	23	—

Absolute Maximum Ratings ^{4,5}

Parameter	Absolute Maximum
Input Power	+ 5 dBm
Operating Supply Voltage	+4.0 Volts
Operating Control Voltage	+3.0 Volts
Operating Temperature	-20 °C to +85 °C
Channel Temperature	+150 °C
Storage Temperature	-40 °C to +150 °C

- Exceeding any one or combination of these limits may cause permanent damage to this device.
- M/A-COM does not recommend sustained operation near these survivability limits.

Logic Table ⁶

V_{EN}	V_M	State
0	0	OFF
0	1	OFF
1	0	LPM
1	1	HPM

6. 1 = +2.0 V to 2.5 V, 0 = 0 V to 0.5 V.

Operating the MAAPSS0081

The MAAPSS0081 is sensitive to electrostatic discharge (ESD). Use proper ESD control techniques when handling this device. To operate the MAAPSS0081, follow these steps. Ramp down or shut down in reverse order.

- Apply V_{CC} (2.4 V).
- Apply V_M (0 or 2.5 V).
- Apply P_{IN} (-2 to 2 dBm).
- Ramp V_{EN} from 0 to 2.5 V.

Recommended PCB Configuration

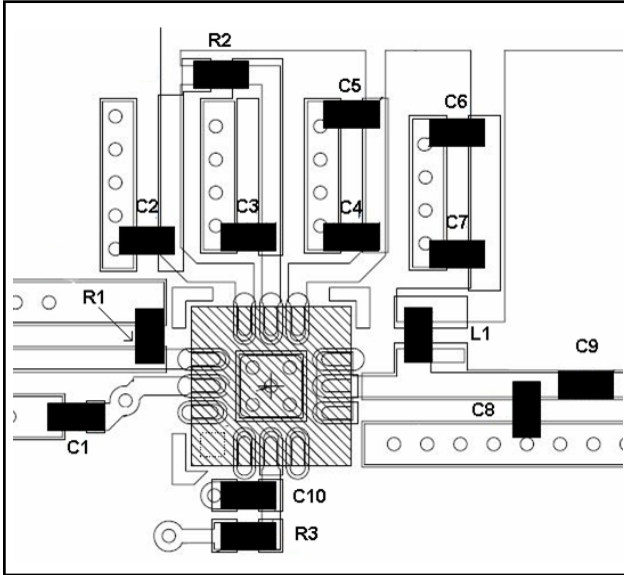

Schematic

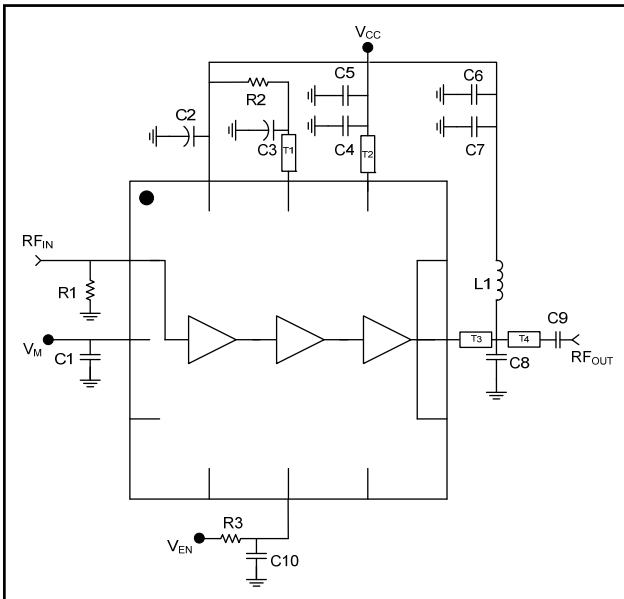

Parts List

Part	Value	Case Style	Manufacturer
C1, C2, C6	0.1 μ F	0402	Murata
C5	1.0 μ F	0402	Murata
C3, C4, C9	47.0 pF	0402	Murata
C7	1000.0 pF	0402	Murata
C8	2.0 pF	0402	Murata
C10	0.022 μ F	0402	Murata
R1, R3	249.0 Ω	0402	Panasonic
R2	806.0 Ω	0402	Panasonic
L1	7.5 nH	0402	Coilcraft

Designator	Length (mm) *	Width (mm)
T1	1.09	0.35
T2	2.19	0.35
T3	3.35	0.37
T4	0.41	0.37

* From package edge to center of component

Handling Procedures

Please observe the following precautions to avoid damage:

Static Sensitivity

Silicon germanium Integrated Circuits are sensitive to electrostatic discharge (ESD) and can be damaged by static electricity. Proper ESD control techniques should be used when handling these devices.

Typical Characteristics @ 2.45 GHz, $V_{CC} = 2.4\text{ V}$ (Low Power Mode)

P_{OUT} , PAE, I_{CC} vs. P_{IN}

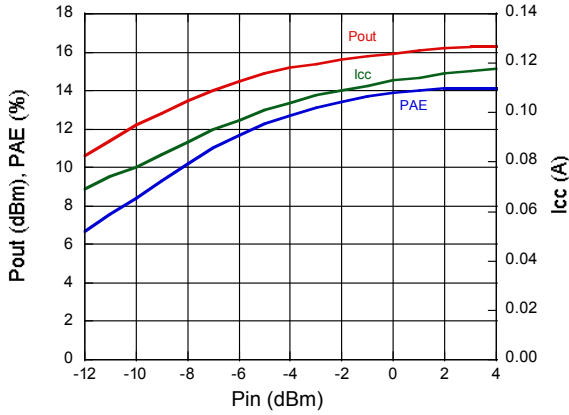

P_{OUT} , PAE, I_{CC} vs. V_{CC}

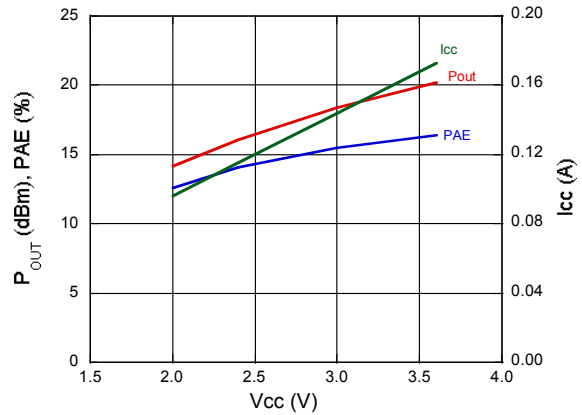

P_{OUT} , PAE, I_{CC} vs. Frequency

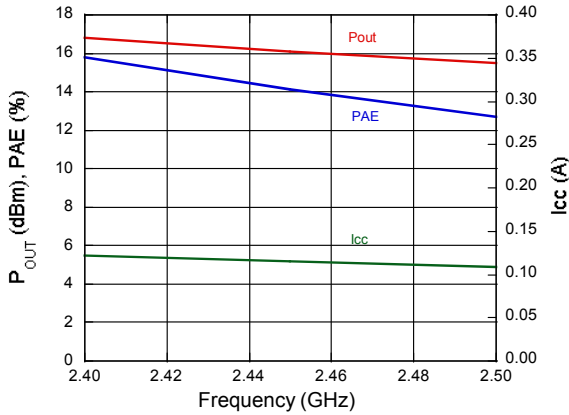

P_{OUT} , Harmonics vs. P_{IN}

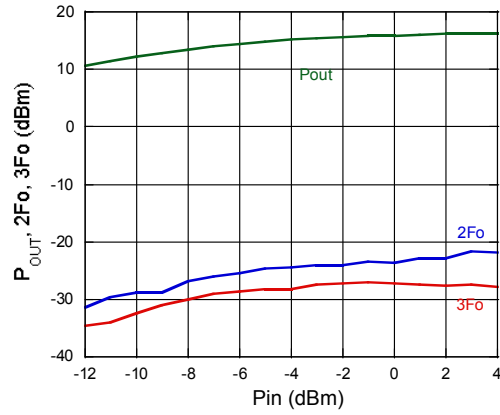

V_{CC} , P_{OUT} vs. Temperature

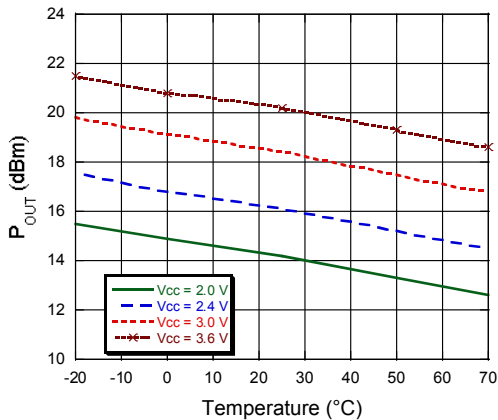

V_{CC} , I_{CC} vs. Temperature

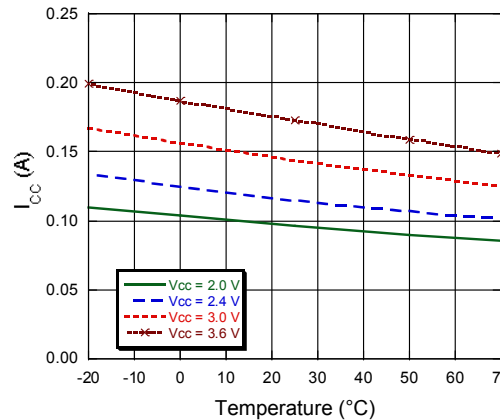

ADVANCED: Data Sheets contain information regarding a product M/A-COM Technology Solutions is considering for development. Performance is based on target specifications, simulated results, and/or prototype measurements. Commitment to develop is not guaranteed.
PRELIMINARY: Data Sheets contain information regarding a product M/A-COM Technology Solutions has under development. Performance is based on engineering tests. Specifications are typical. Mechanical outline has been fixed. Engineering samples and/or test data may be available. Commitment to produce in volume is not guaranteed.

- **North America** Tel: 800.366.2266 / Fax: 978.366.2266
- **Europe** Tel: 44.1908.574.200 / Fax: 44.1908.574.300
- **Asia/Pacific** Tel: 81.44.844.8296 / Fax: 81.44.844.8298

Visit www.macomtech.com for additional data sheets and product information.

M/A-COM Technology Solutions Inc. and its affiliates reserve the right to make changes to the product(s) or information contained herein without notice.

Typical Characteristics @ 2.45 GHz, $V_{CC} = 2.4\text{ V}$ (High Power Mode)

P_{OUT} , PAE, I_{CC} vs. P_{IN}

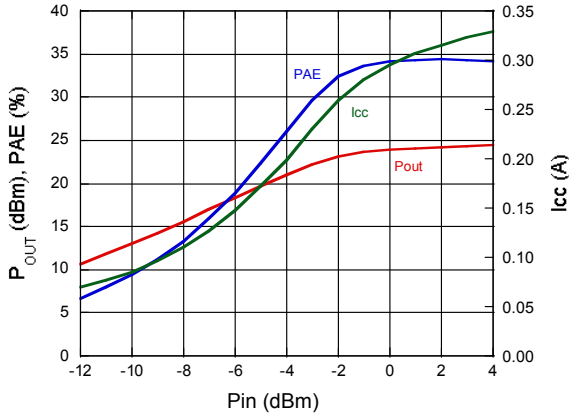

P_{OUT} , PAE, I_{CC} vs. V_{CC}

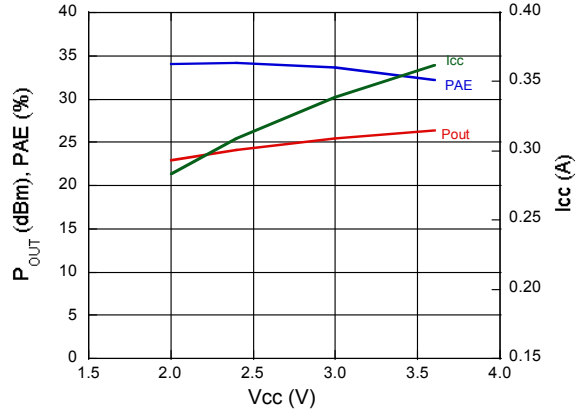

P_{OUT} , PAE, I_{CC} vs. Frequency

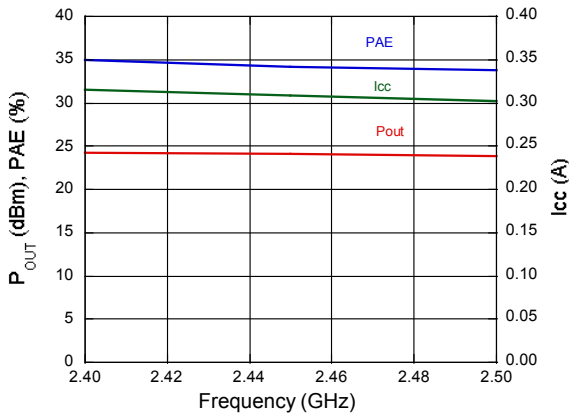

P_{OUT} , Harmonics vs. P_{IN}

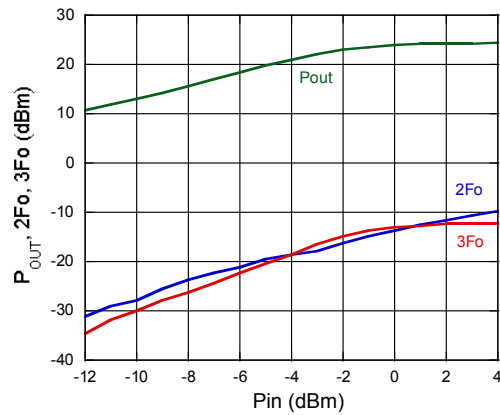

V_{CC} , P_{OUT} vs. Temperature

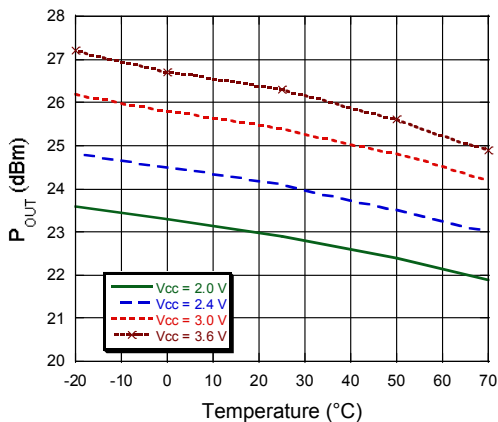

V_{CC} , I_{CC} vs. Temperature

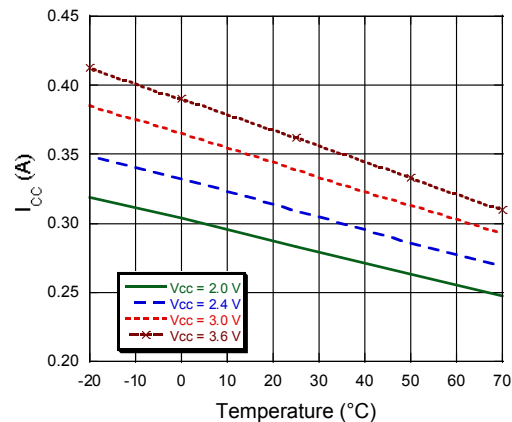

ADVANCED: Data Sheets contain information regarding a product M/A-COM Technology Solutions is considering for development. Performance is based on target specifications, simulated results, and/or prototype measurements. Commitment to develop is not guaranteed.
PRELIMINARY: Data Sheets contain information regarding a product M/A-COM Technology Solutions has under development. Performance is based on engineering tests. Specifications are typical. Mechanical outline has been fixed. Engineering samples and/or test data may be available. Commitment to produce in volume is not guaranteed.

- **North America** Tel: 800.366.2266 / Fax: 978.366.2266
- **Europe** Tel: 44.1908.574.200 / Fax: 44.1908.574.300
- **Asia/Pacific** Tel: 81.44.844.8296 / Fax: 81.44.844.8298

Visit www.macomtech.com for additional data sheets and product information.

M/A-COM Technology Solutions Inc. and its affiliates reserve the right to make changes to the product(s) or information contained herein without notice.

Typical Characteristics @ 2.45 GHz, $V_{CC} = 2.4\text{ V}$ (High Power Mode)

S21 vs. Frequency

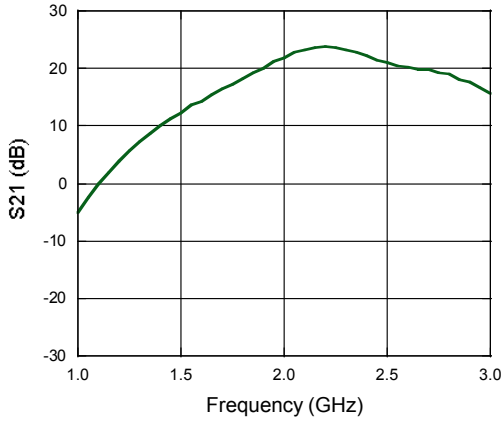

S11, S22 vs. Frequency

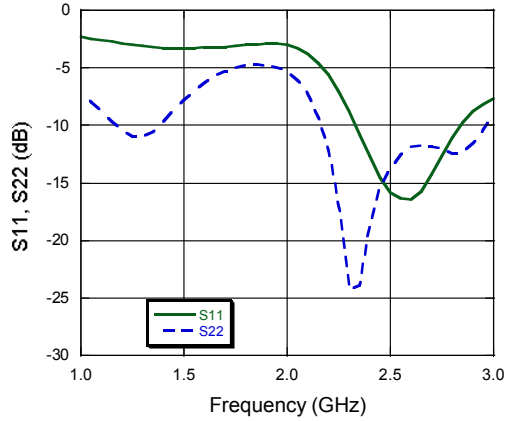

Lead-Free 3 mm 12-Lead PQFN[†]

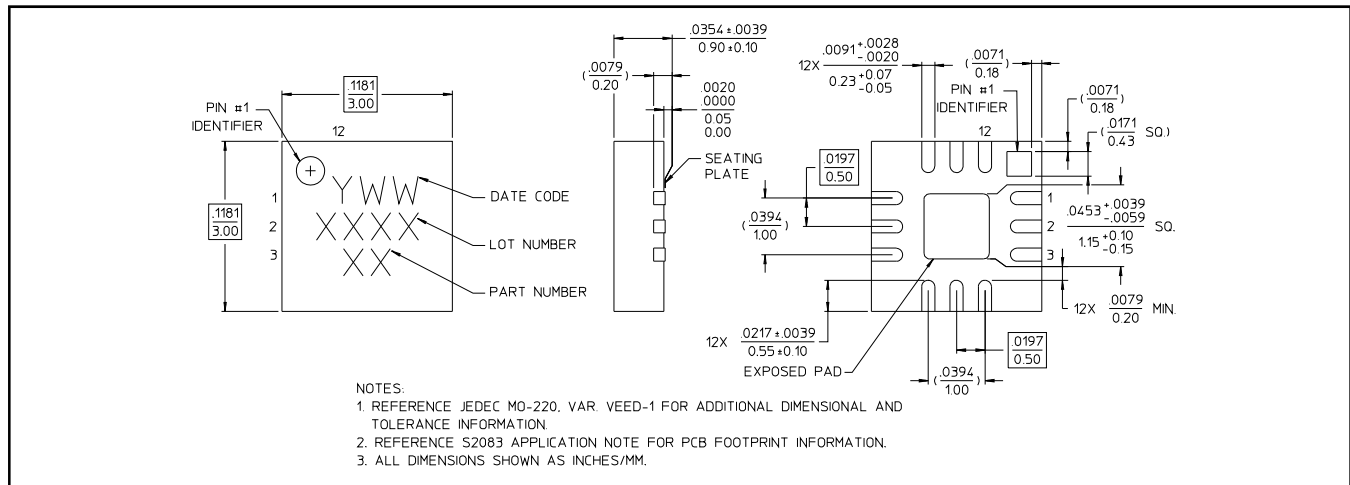

[†] Reference Application Note M538 for lead-free solder reflow recommendations.
 Meets JEDEC moisture sensitivity level 1 requirements.