

# MAC4DHM

Preferred Device

## Sensitive Gate Triacs

### Silicon Bidirectional Thyristors

Designed for high volume, low cost, industrial and consumer applications such as motor control; process control; temperature, light and speed control.

- Small Size Surface Mount DPAK Package
- Passivated Die for Reliability and Uniformity
- Four-Quadrant Triggering
- Blocking Voltage to 600 V
- On-State Current Rating of 4.0 Amperes RMS at 93°C
- Low Level Triggering and Holding Characteristics
- Device Marking: Device Type with “M” truncated, e.g., MAC4DHM: AC4DHM, Date Code



**ON Semiconductor**

<http://onsemi.com>

**TRIACS**  
**4.0 AMPERES RMS**  
**600 VOLTS**

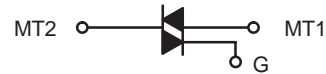

#### MAXIMUM RATINGS (T<sub>J</sub> = 25°C unless otherwise noted)

Rating	Symbol	Value	Unit
Peak Repetitive Off-State Voltage <sup>(1)</sup> (T <sub>J</sub> = -40 to 110°C, Sine Wave, 50 to 60 Hz, Gate Open) MAC4DHM	V <sub>DRM</sub> , V <sub>RRM</sub>	600	Volts
On-State RMS Current (Full Cycle Sine Wave, 60 Hz, T <sub>C</sub> = 93°C)	I <sub>T(RMS)</sub>	4.0	Amps
Peak Non-Repetitive Surge Current (One Full Cycle, 60 Hz, T <sub>J</sub> = 110°C)	I <sub>TSM</sub>	40	Amps
Circuit Fusing Consideration (t = 8.3 msec)	I <sup>2</sup> t	6.6	A <sup>2</sup> sec
Peak Gate Power (Pulse Width ≤ 10 μsec, T <sub>C</sub> = 93°C)	P <sub>GM</sub>	0.5	Watts
Average Gate Power (t = 8.3 msec, T <sub>C</sub> = 93°C)	P <sub>G(AV)</sub>	0.1	Watts
Peak Gate Current (Pulse Width ≤ 10 μsec, T <sub>C</sub> = 93°C)	I <sub>GM</sub>	0.2	Amps
Peak Gate Voltage (Pulse Width ≤ 10 μsec, T <sub>C</sub> = 93°C)	V <sub>GM</sub>	5.0	Volts
Operating Junction Temperature Range	T <sub>J</sub>	-40 to 110	°C
Storage Temperature Range	T <sub>stg</sub>	-40 to 150	°C

(1) V<sub>DRM</sub> and V<sub>RRM</sub> for all types can be applied on a continuous basis. Blocking voltages shall not be tested with a constant current source such that the voltage ratings of the device are exceeded.

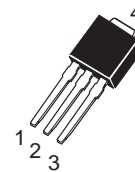

**D-PAK**  
**CASE 369**  
**STYLE 6**

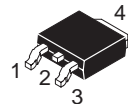

**D-PAK**  
**CASE 369A**  
**STYLE 6**

#### PIN ASSIGNMENT

Pin	Assignment
1	Main Terminal 1
2	Main Terminal 2
3	Gate
4	Main Terminal 2

#### ORDERING INFORMATION

Device	Package	Shipping
MAC4DHMT4	DPAK 369A	16mm Tape and Reel (2.5K/Reel)
MAC4DHM-1	DPAK 369	75 Units/Rail

**Preferred** devices are recommended choices for future use and best overall value.

# MAC4DHM

## THERMAL CHARACTERISTICS

Characteristic	Symbol	Max	Unit
Thermal Resistance — Junction to Case	$R_{\theta JC}$	3.5	$^{\circ}C/W$
— Junction to Ambient	$R_{\theta JA}$	88	
— Junction to Ambient <sup>(1)</sup>	$R_{\theta JA}$	80	
Maximum Lead Temperature for Soldering Purposes <sup>(2)</sup>	$T_L$	260	$^{\circ}C$

(1) Surface mounted on minimum recommended pad size.

(2) 1/8" from case for 10 seconds.

## ELECTRICAL CHARACTERISTICS ( $T_J = 25^{\circ}C$ unless otherwise noted; Electricals apply in both directions)

Characteristic	Symbol	Min	Typ	Max	Unit
----------------	--------	-----	-----	-----	------

### OFF CHARACTERISTICS

Peak Repetitive Blocking Current ( $V_D = \text{Rated } V_{DRM}, V_{RRM}$ ; Gate Open)	$I_{DRM}, I_{RRM}$	—	—	0.01 2.0	mA
					$T_J = 25^{\circ}C$ $T_J = 110^{\circ}C$

### ON CHARACTERISTICS

Peak On-State Voltage <sup>(1)</sup> ( $I_{TM} = \pm 6.0 A$ )	$V_{TM}$	—	1.3	1.6	Volts
Gate Trigger Current (Continuous dc) ( $V_D = 12 V, R_L = 100 \Omega$ ) MT2(+), G(+) MT2(+), G(-) MT2(-), G(-) MT2(-), G(+)	$I_{GT}$	—	1.8 2.1 2.4 4.2	5.0 5.0 5.0 10	mA
Gate Trigger Voltage (Continuous dc) ( $V_D = 12 V, R_L = 100 \Omega$ ) MT2(+), G(+) MT2(+), G(-) MT2(-), G(-) MT2(-), G(+)	$V_{GT}$	0.5 0.5 0.5 0.5	0.62 0.57 0.65 0.74	1.3 1.3 1.3 1.3	Volts
Gate Non-Trigger Voltage (Continuous dc) ( $V_D = 12 V, R_L = 100 \Omega, T_J = 110^{\circ}C$ ) All Four Quadrants	$V_{GD}$	0.1	0.4	—	Volts
Holding Current ( $V_D = 12 V, \text{Gate Open, Initiating Current} = \pm 200 \text{ mA}$ )	$I_H$	—	1.5	15	mA
Latching Current MT2(+), G(+) MT2(+), G(-) MT2(-), G(-) MT2(-), G(+)	$I_L$	—	1.75 5.2 2.1 2.2	10 10 10 10	mA
					( $V_D = 12 V, I_G = 5.0 \text{ mA}$ ) ( $V_D = 12 V, I_G = 5.0 \text{ mA}$ ) ( $V_D = 12 V, I_G = 5.0 \text{ mA}$ ) ( $V_D = 12 V, I_G = 10 \text{ mA}$ )

### DYNAMIC CHARACTERISTICS

Characteristic	Symbol	Min	Typ	Max	Unit
Rate of Change of Commutating Current ( $V_D = 200 V, I_{TM} = 1.8 A, \text{Commutating } dv/dt = 1.0 V/\mu\text{sec}, T_J = 110^{\circ}C, f = 250 \text{ Hz}, CL = 5.0 \mu\text{fd}, LL = 80 \text{ mH}, RS = 56 \Omega, CS = 0.03 \mu\text{fd}$ ) With snubber see Figure 11	$di/dt(c)$	—	3.0	—	A/ms
Critical Rate of Rise of Off-State Voltage ( $V_D = 0.67 \times \text{Rated } V_{DRM}, \text{Exponential Waveform, Gate Open, } T_J = 110^{\circ}C$ )	$dv/dt$	20	—	—	V/ $\mu\text{s}$

(1) Pulse Test: Pulse Width  $\leq 2.0$  msec, Duty Cycle  $\leq 2\%$ .

# MAC4DHM

## Voltage Current Characteristic of Triacs (Bidirectional Device)

Symbol	Parameter
$V_{DRM}$	Peak Repetitive Forward Off State Voltage
$I_{DRM}$	Peak Forward Blocking Current
$V_{RRM}$	Peak Repetitive Reverse Off State Voltage
$I_{RRM}$	Peak Reverse Blocking Current
$V_{TM}$	Maximum On State Voltage
$I_H$	Holding Current

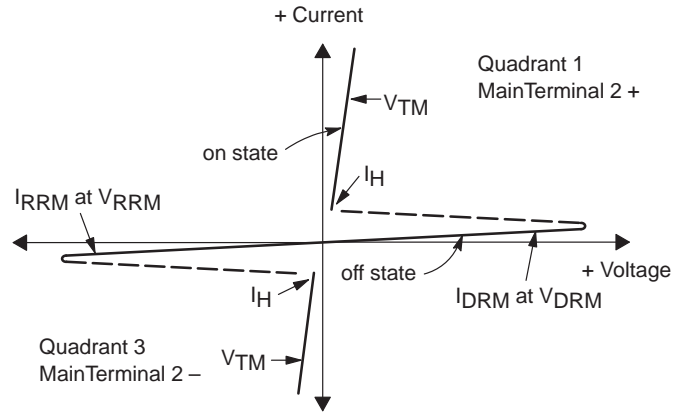

### Quadrant Definitions for a Triac

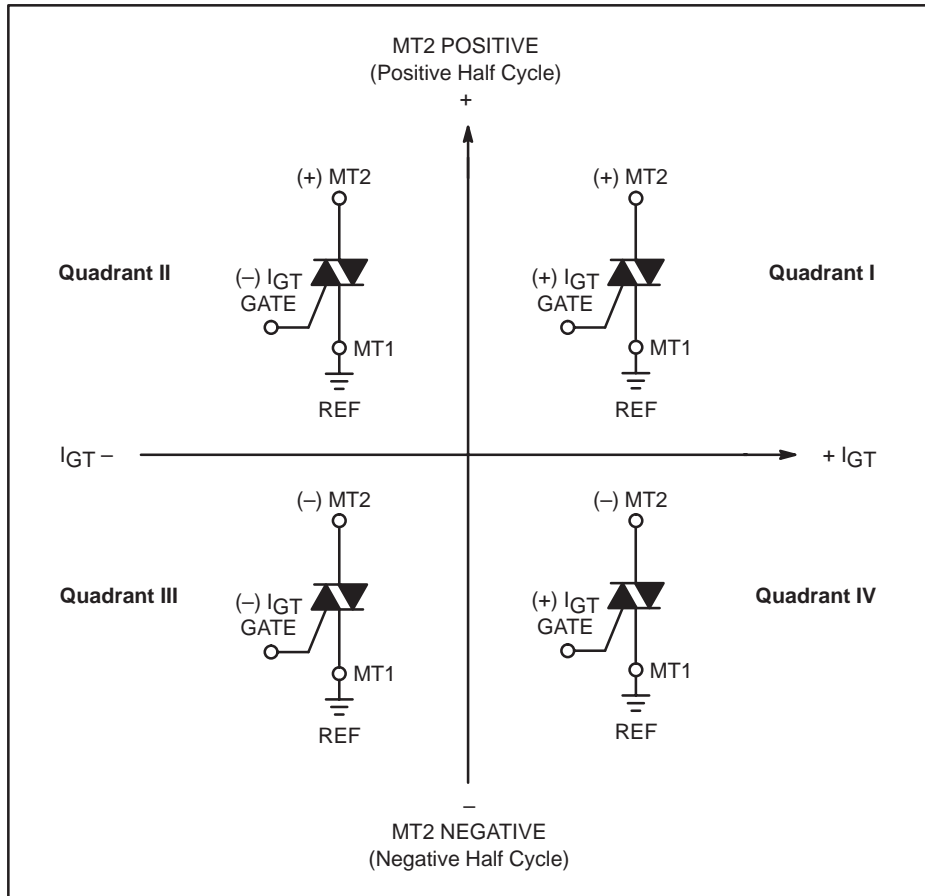

All polarities are referenced to MT1.  
With in-phase signals (using standard AC lines) quadrants I and III are used.

# MAC4DHM

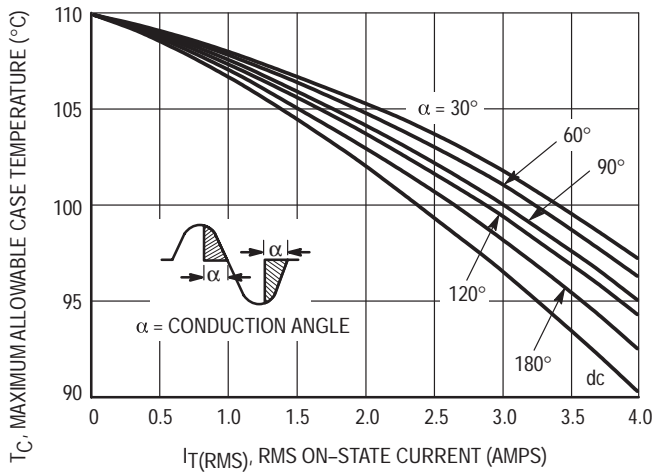

Figure 1. RMS Current Derating

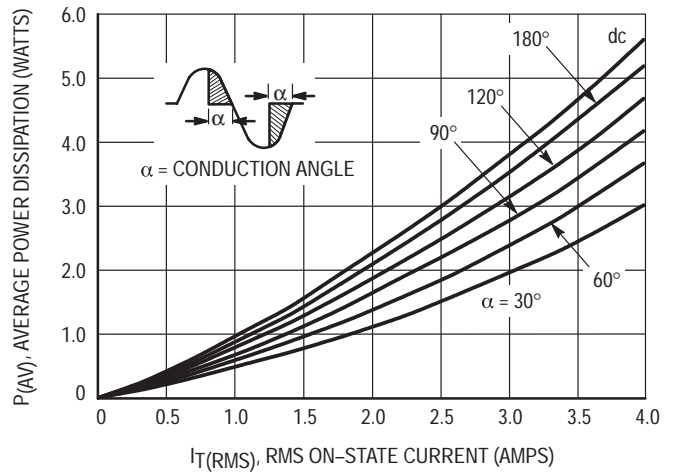

Figure 2. On-State Power Dissipation

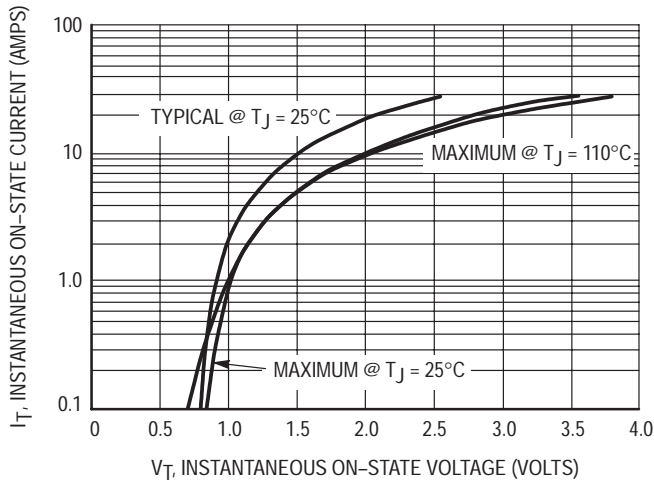

Figure 3. On-State Characteristics

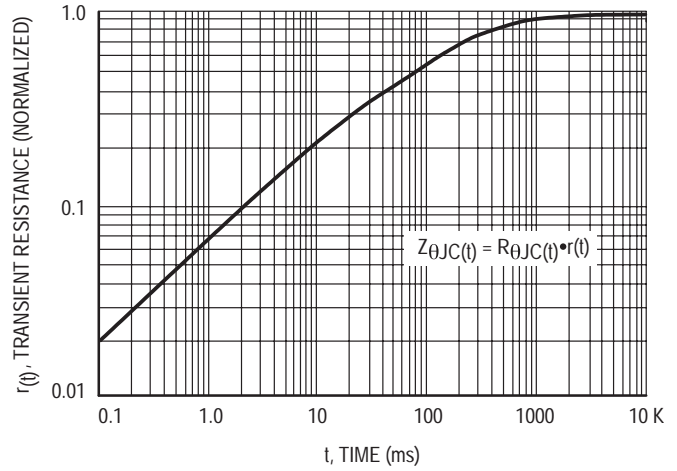

Figure 4. Transient Thermal Response

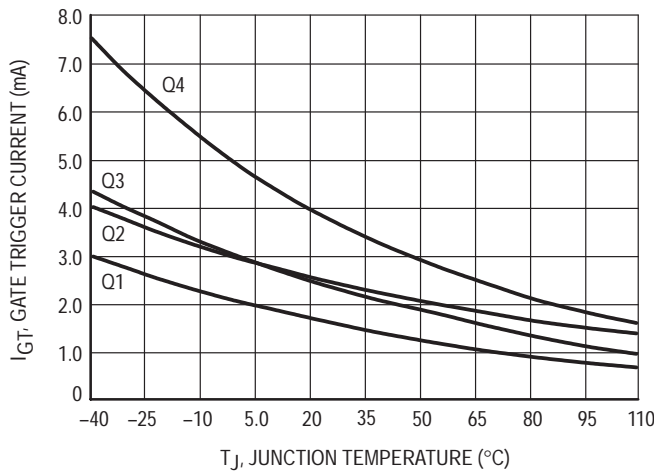

Figure 5. Typical Gate Trigger Current versus Junction Temperature

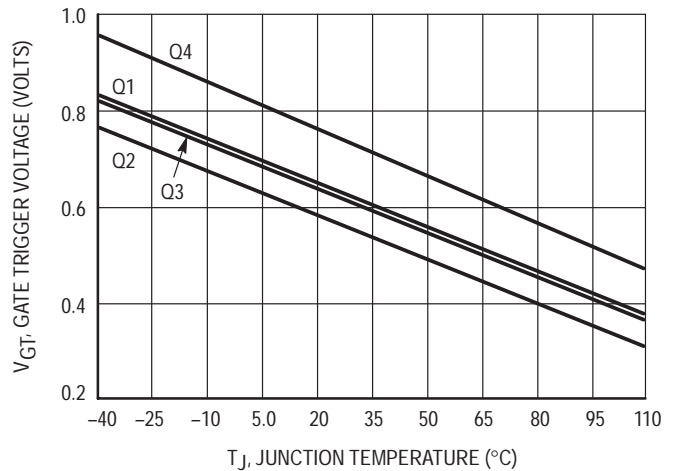
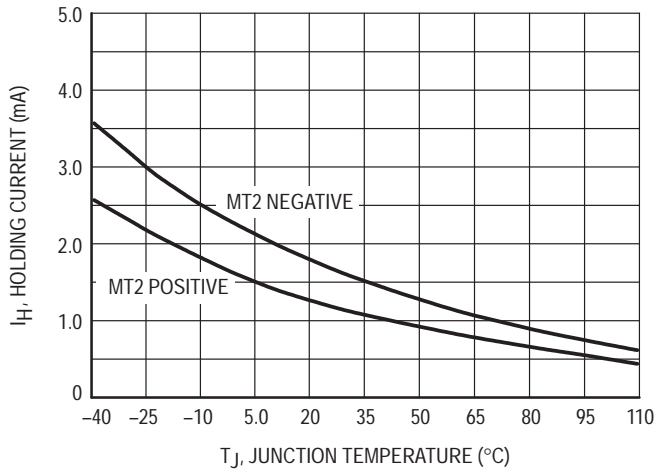
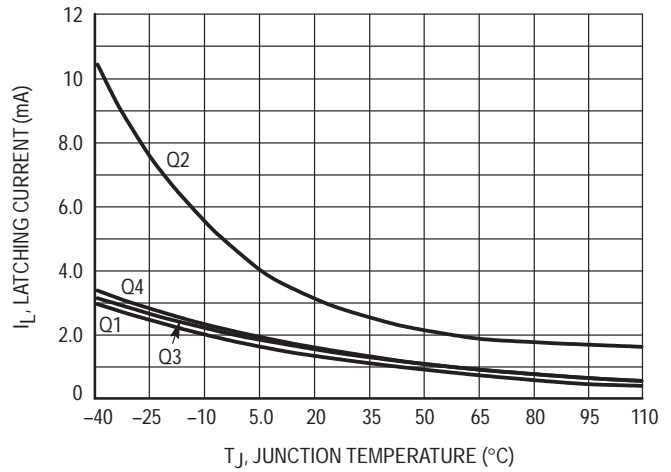

Figure 6. Typical Gate Trigger Voltage versus Junction Temperature

# MAC4DHM



**Figure 7. Typical Holding Current versus Junction Temperature**



**Figure 8. Typical Latching Current versus Junction Temperature**

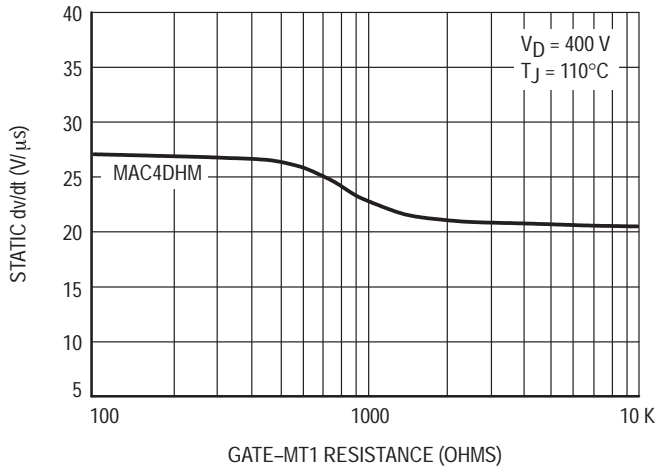

**Figure 9. Minimum Exponential Static dv/dt versus Gate-MT1 Resistance**

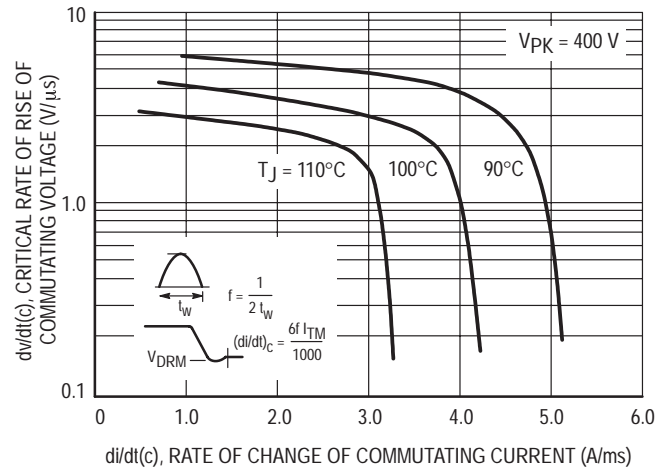

**Figure 10. Typical Critical Rate of Rise of Commutating Voltage**

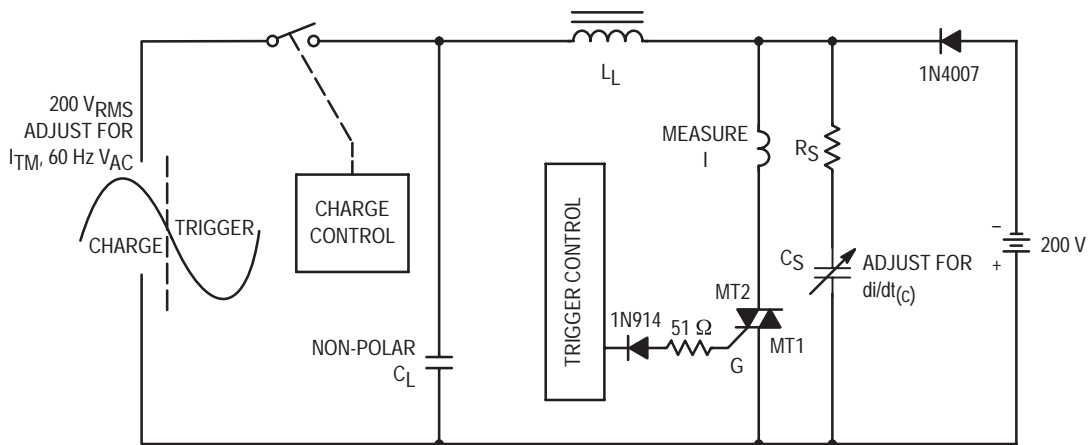

Note: Component values are for verification of rated  $(di/dt)_c$ . See AN1048 for additional information.

**Figure 11. Simplified Test Circuit to Measure the Critical Rate of Rise of Commutating Current  $(di/dt)_c$**

# MAC4DHM

## MINIMUM RECOMMENDED FOOTPRINT FOR SURFACE MOUNTED APPLICATIONS

Surface mount board layout is a critical portion of the total design. The footprint for the semiconductor packages must be the correct size to insure proper solder connection

interface between the board and the package. With the correct pad geometry, the packages will self align when subjected to a solder reflow process.

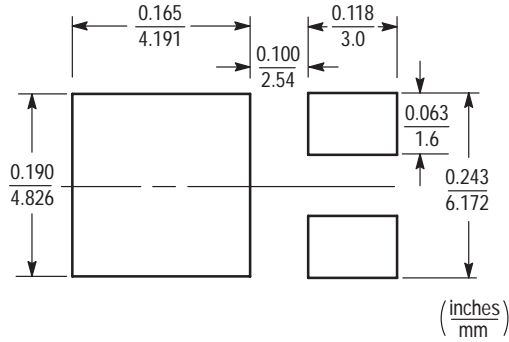

DPAK

# MAC4DHM

## PACKAGE DIMENSIONS

### D-PAK CASE 369-07 ISSUE L

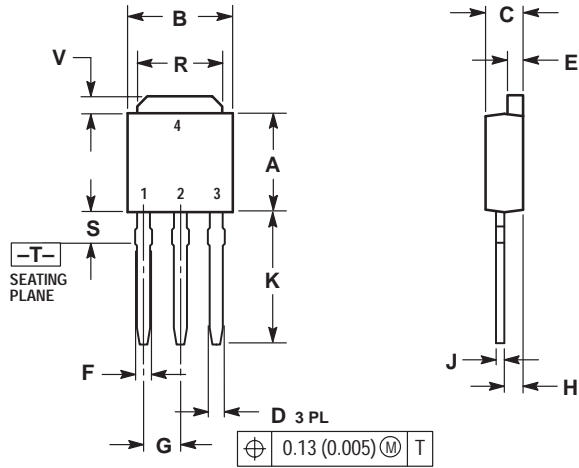

- NOTES:  
 1. DIMENSIONING AND TOLERANCING PER ANSI Y14.5M, 1982.  
 2. CONTROLLING DIMENSION: INCH.

DIM	INCHES		MILLIMETERS	
	MIN	MAX	MIN	MAX
A	0.235	0.250	5.97	6.35
B	0.250	0.265	6.35	6.73
C	0.086	0.094	2.19	2.38
D	0.027	0.035	0.69	0.88
E	0.033	0.040	0.84	1.01
F	0.037	0.047	0.94	1.19
G	0.090 BSC		2.29 BSC	
H	0.034	0.040	0.87	1.01
J	0.018	0.023	0.46	0.58
K	0.350	0.380	8.89	9.65
R	0.175	0.215	4.45	5.46
S	0.050	0.090	1.27	2.28
V	0.030	0.050	0.77	1.27

- STYLE 6:  
 PIN 1. MT1  
 2. MT2  
 3. GATE  
 4. MT2

### D-PAK CASE 369A-13 ISSUE Z

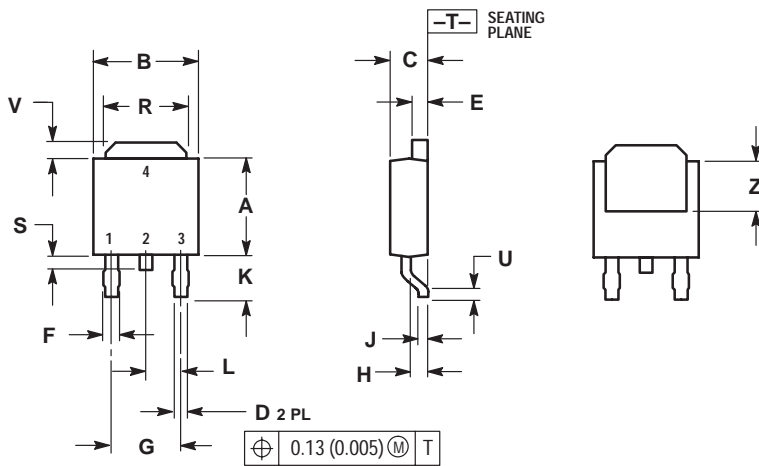

- NOTES:  
 1. DIMENSIONING AND TOLERANCING PER ANSI Y14.5M, 1982.  
 2. CONTROLLING DIMENSION: INCH.

DIM	INCHES		MILLIMETERS	
	MIN	MAX	MIN	MAX
A	0.235	0.250	5.97	6.35
B	0.250	0.265	6.35	6.73
C	0.086	0.094	2.19	2.38
D	0.027	0.035	0.69	0.88
E	0.033	0.040	0.84	1.01
F	0.037	0.047	0.94	1.19
G	0.180 BSC		4.58 BSC	
H	0.034	0.040	0.87	1.01
J	0.018	0.023	0.46	0.58
K	0.102	0.114	2.60	2.89
L	0.090 BSC		2.29 BSC	
R	0.175	0.215	4.45	5.46
S	0.020	0.050	0.51	1.27
U	0.020	---	0.51	---
V	0.030	0.050	0.77	1.27
Z	0.138	---	3.51	---

- STYLE 6:  
 PIN 1. MT1  
 2. MT2  
 3. GATE  
 4. MT2

# MAC4DHM

**ON Semiconductor** and  are trademarks of Semiconductor Components Industries, LLC (SCILLC). SCILLC reserves the right to make changes without further notice to any products herein. SCILLC makes no warranty, representation or guarantee regarding the suitability of its products for any particular purpose, nor does SCILLC assume any liability arising out of the application or use of any product or circuit, and specifically disclaims any and all liability, including without limitation special, consequential or incidental damages. "Typical" parameters which may be provided in SCILLC data sheets and/or specifications can and do vary in different applications and actual performance may vary over time. All operating parameters, including "Typicals" must be validated for each customer application by customer's technical experts. SCILLC does not convey any license under its patent rights nor the rights of others. SCILLC products are not designed, intended, or authorized for use as components in systems intended for surgical implant into the body, or other applications intended to support or sustain life, or for any other application in which the failure of the SCILLC product could create a situation where personal injury or death may occur. Should Buyer purchase or use SCILLC products for any such unintended or unauthorized application, Buyer shall indemnify and hold SCILLC and its officers, employees, subsidiaries, affiliates, and distributors harmless against all claims, costs, damages, and expenses, and reasonable attorney fees arising out of, directly or indirectly, any claim of personal injury or death associated with such unintended or unauthorized use, even if such claim alleges that SCILLC was negligent regarding the design or manufacture of the part. SCILLC is an Equal Opportunity/Affirmative Action Employer.

## PUBLICATION ORDERING INFORMATION

### **NORTH AMERICA Literature Fulfillment:**

Literature Distribution Center for ON Semiconductor  
P.O. Box 5163, Denver, Colorado 80217 USA  
**Phone:** 303-675-2175 or 800-344-3860 Toll Free USA/Canada  
**Fax:** 303-675-2176 or 800-344-3867 Toll Free USA/Canada  
**Email:** ONlit@hibbertco.com  
Fax Response Line: 303-675-2167 or 800-344-3810 Toll Free USA/Canada

**N. American Technical Support:** 800-282-9855 Toll Free USA/Canada

**EUROPE:** LDC for ON Semiconductor – European Support

**German Phone:** (+1) 303-308-7140 (M-F 1:00pm to 5:00pm Munich Time)  
**Email:** ONlit-german@hibbertco.com  
**French Phone:** (+1) 303-308-7141 (M-F 1:00pm to 5:00pm Toulouse Time)  
**Email:** ONlit-french@hibbertco.com  
**English Phone:** (+1) 303-308-7142 (M-F 12:00pm to 5:00pm UK Time)  
**Email:** ONlit@hibbertco.com

**EUROPEAN TOLL-FREE ACCESS\*: 00-800-4422-3781**

\*Available from Germany, France, Italy, England, Ireland

### **CENTRAL/SOUTH AMERICA:**

**Spanish Phone:** 303-308-7143 (Mon-Fri 8:00am to 5:00pm MST)  
**Email:** ONlit-spanish@hibbertco.com

**ASIA/PACIFIC:** LDC for ON Semiconductor – Asia Support

**Phone:** 303-675-2121 (Tue-Fri 9:00am to 1:00pm, Hong Kong Time)  
Toll Free from Hong Kong & Singapore:  
**001-800-4422-3781**  
**Email:** ONlit-asia@hibbertco.com

**JAPAN:** ON Semiconductor, Japan Customer Focus Center  
4-32-1 Nishi-Gotanda, Shinagawa-ku, Tokyo, Japan 141-0031

**Phone:** 81-3-5740-2745  
**Email:** r14525@onsemi.com

**ON Semiconductor Website:** <http://onsemi.com>

For additional information, please contact your local Sales Representative.