

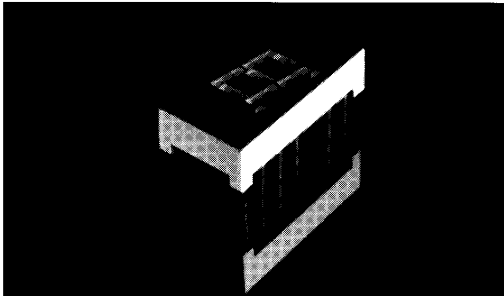

**0.400-INCH
SEVEN SEGMENT DISPLAYS**

**HIGH EFFICIENCY GREEN MAN4400A SERIES
ORANGE MAN4600A SERIES
RED MAN4700A SERIES**



FEATURES

- Common anode or common cathode models
- Red, Green and Orange
- Fast switching—excellent for multiplexing
- Low power consumption
- Bold solid segments that are highly legible
- Solid state reliability—long operation life
- Impact resistant plastic construction
- Directly compatible with integrated circuits
- High brightness with high contrast
- Categorized for Luminous Intensity (See Note 6)
- Standard 14 pin dual-in-line package configuration
- Wide angle viewing . . . 150°
- Package size and lead configuration is the same as MAN50A/3600A/70A/80A Series

DESCRIPTION

The MAN4400, MAN4600, MAN4700 and MAN4800 Series provides superior brightness in a choice of color LED displays. Standard units are available in Red, Green, and Orange. They can be mounted in arrays with 0.400-inch (10.16 mm) center-to-center spacing. The Green displays are constructed with Grey face and neutral segment color. Red displays have Black faces and Red segment color. Others have face and segment color corresponding to the emitted light.

APPLICATIONS

- For industrial and consumer applications such as:
- Digital readout displays
 - Instrument panels
 - Point of sale equipment
 - Calculators
 - Digital clocks
 - High ambient light conditions

MODEL NUMBERS

PART NUMBER	COLOR	DESCRIPTION	PACKAGE DRAWING	PIN OUT SPECIFICATION
MAN4410A	Green	Common Anode; Right Hand Decimal	A	A
MAN4440A	Green	Common Cathode; Right Hand Decimal	A	C
MAN4610A	Orange	Common Anode; Right Hand Decimal	A	A
MAN4630A	Orange	Common Anode; Overflow ± 1 ; Right Hand Decimal	B	B
MAN4640A	Orange	Common Cathode; Right Hand Decimal	A	C
MAN4705A	Red	Universal (CA or CC) Overflow ± 1 ; Right Hand Decimal	B	D
MAN4710A	Red	Common Anode; Right Hand Decimal	A	A
MAN4740A	Red	Common Cathode; Right Hand Decimal	A	C



0.400-INCH SEVEN SEGMENT DISPLAYS

RECOMMENDED OPTICAL FILTER			
For optimum ON and OFF contrast, one of the following filters or equivalents should be used over the display:			
DEVICE TYPE	FILTER	DEVICE TYPE	FILTER
MAN4410A } MAN4440A }	Panelgraphic Green 48	MAN4705A } MAN4710A } MAN4740A }	Panelgraphic Red 60 Homalite 100-1605
MAN4610A } MAN4630A } MAN4640A }	Panelgraphic Scarlet 65 Homalite 100-1670		
NOTE: When using the Grey face MAN4480 or MAN4880 in situations of high ambient light, a neutral density filter can be used to achieve a greater contrast. The following or equivalent can be used: Panelgraphic Grey 10.			

ELECTRO-OPTICAL CHARACTERISTICS (25°C Free Air Temperature Unless Otherwise Specified)					
	MIN.	TYP.	MAX.	UNITS	TEST CONDITIONS
MAN4410A/4440A					
Luminous Intensity, digit average (See Note 1 and 3)	750	3200		μcd	$I_f = 10 \text{ mA}$
Peak emission wavelength		562		nm	
Forward voltage					
Segment		2.2	3.0	V	$I_f = 20 \text{ mA}$
Decimal point		2.2	3.0	V	$I_f = 20 \text{ mA}$
Dynamic resistance					
Segment		12		Ω	$I_f = 20 \text{ mA}$
Decimal point		12		Ω	$I_f = 20 \text{ mA}$
Capacitance					
Segment		40		pF	$V = 0$
Decimal point		40		pF	$V = 0$
Reverse current					
Segment			100	μA	$V_R = 5.0 \text{ V}$
Decimal point			100	μA	$V_R = 5.0 \text{ V}$
MAN4610A/4630A/4640A					
Luminous Intensity, digit average (See Note 1 and 3)	510	1800		μcd	$I_f = 10 \text{ mA}$
Peak emission wavelength		630		nm	
Forward voltage					
Segment		2.2	2.5	V	$I_f = 20 \text{ mA}$
Decimal point		2.2	2.5	V	$I_f = 20 \text{ mA}$
Dynamic resistance					
Segment		26		Ω	$I_f = 20 \text{ mA}$
Decimal point		26		Ω	$I_f = 20 \text{ mA}$
Capacitance					
Segment		35		pF	$V = 0$
Decimal point		35		pF	$V = 0$
Reverse current					
Segment			100	μA	$V_R = 5.0 \text{ V}$
Decimal point			100	μA	$V_R = 5.0 \text{ V}$

PACKAGE DIMENSIONS

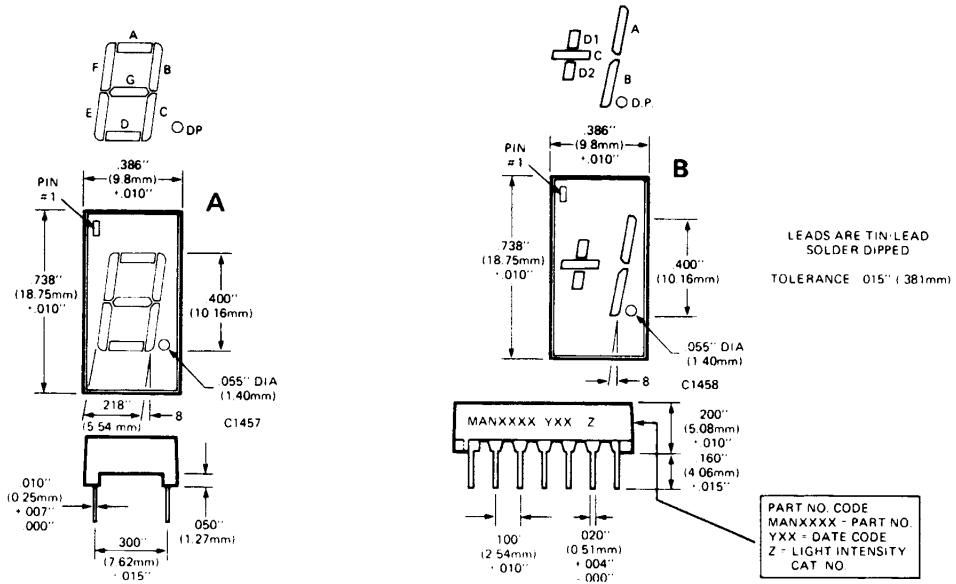

NOTES

1. The digit average Luminous Intensity is obtained by summing the Luminous Intensity of each segment and dividing by the total number of segments. Intensity will not vary more than $\pm 33.3\%$ between all segments within a digit.
2. The curve in Figures 3, 6, 9, and 12 is normalized to the brightness at 25°C to indicate the relative Luminous Intensity over the operating temperature range.
3. The decimal point is designed to have the same surface brightness as the segments, therefore, the Luminous Intensity of the decimal point is .3 times the Luminous Intensity of the segments, since the area of the decimal point is .3 times the area of the average segment.
4. Leads of the device immersed to 1/16 inch from the body. Maximum device surface temperature is 140°C.
5. For flux removal, Freon TF, Freon TE, Isoproponal or water may be used up to their boiling points.
6. All displays are categorized for Luminous Intensity. The Intensity category is marked on each part as a suffix letter to the part number.



0.400-INCH SEVEN SEGMENT DISPLAYS

ELECTRICAL CONNECTIONS

PIN NO.	ELECTRICAL CONNECTIONS			
	A MAN4410A/4610A/4710A	B MAN4630A	C MAN4440A/4640A/4740A	D MAN4705A
1	Cathode A	Anode C, D	Anode F	Anode D1
2	Cathode F	No Pin	Anode G	No Pin
3	Common Anode	Anode C, D	No Pin	Cathode D1
4	No Pin	No Pin	Common Cathode	Cathode C
5	No Pin	No Pin	No Pin	Cathode D2
6	No Pin	No Connection	Anode E	Anode D2
7	Cathode E	Cathode D	Anode D	Anode C
8	Cathode D	Cathode C	Anode C	Anode D.P.
9	Cathode D.P.	Cathode D.P.	Anode D.P.	No Pin
10	Cathode C	Cathode B	No Pin	Cathode D.P.
11	Cathode G	Cathode A	No Connection	Cathode B
12	No Pin	No Pin	Common Cathode	Cathode A
13	Cathode B	No Pin	Anode B	Anode A
14	Common Anode	Anode A, B, & D.P.	Anode A	Anode B

ELECTRICAL SCHEMATIC

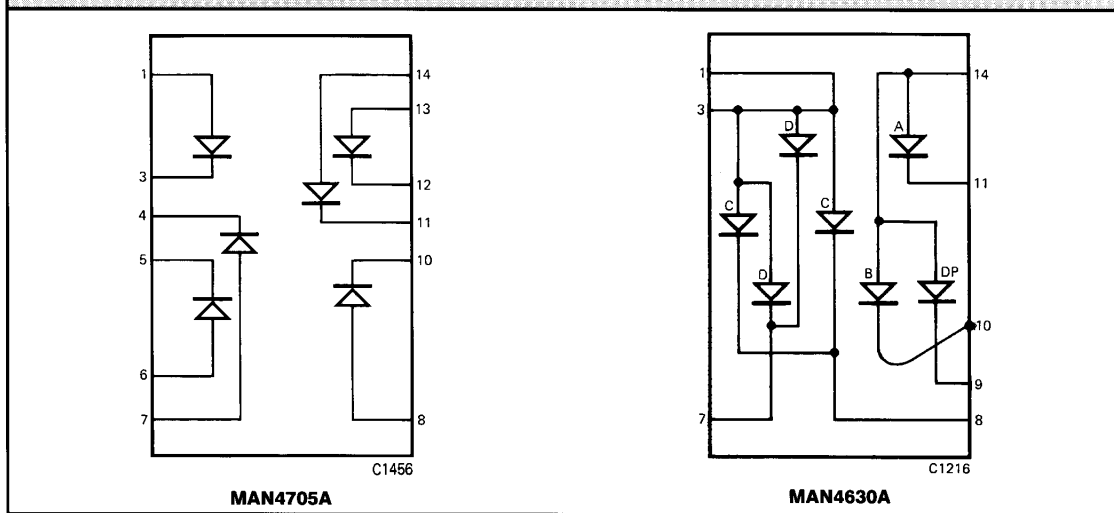

TYPICAL CHARACTERISTIC CURVES

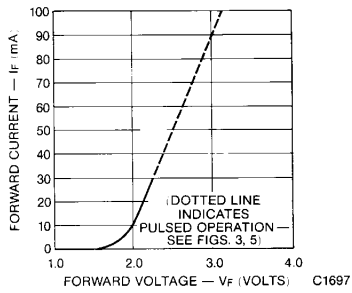

Fig. 1. Forward Current vs. Forward Voltage

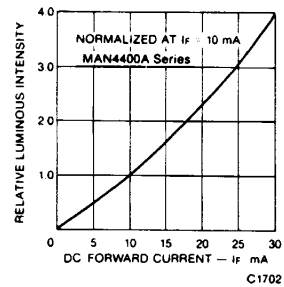

Fig. 2. Luminous Intensity vs. Forward Current

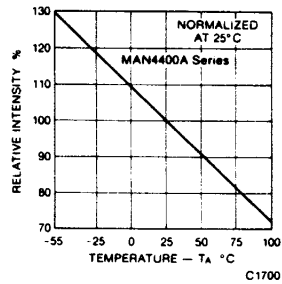

Fig. 3. Relative Luminous Intensity vs. Temperature

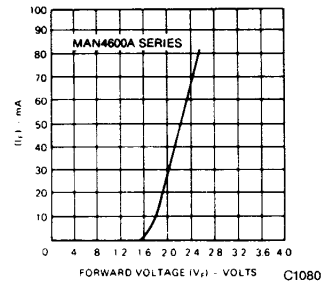

Fig. 4. Forward Current vs. Forward Voltage

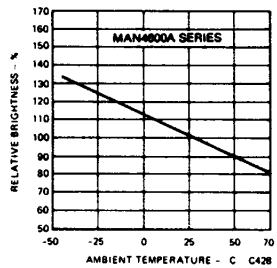

Fig. 5. Relative Luminous Intensity vs. Temperature

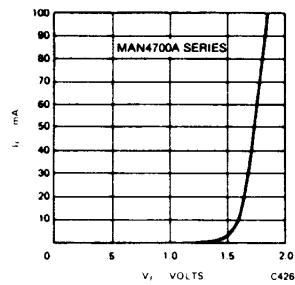

Fig. 6. Forward Current vs. Forward Voltage

TYPICAL CHARACTERISTIC CURVES (Cont'd)

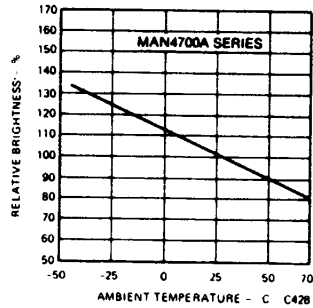

Fig. 7. Relative Luminous Intensity vs. Temperature

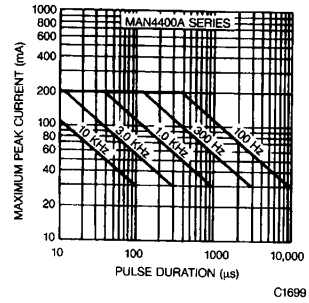

Fig. 8. Max Peak Current vs. Duty Cycle

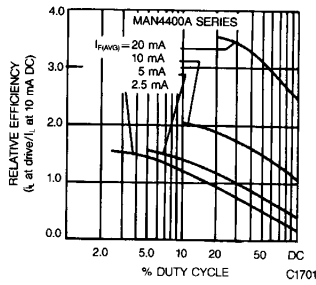

Fig. 9. Relative Luminous Intensity vs. Duty Cycle

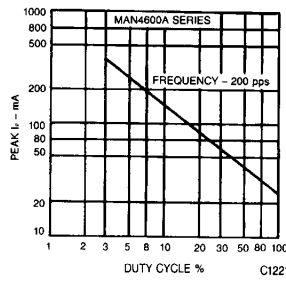

Fig. 10. Max Peak Current vs. Duty Cycle

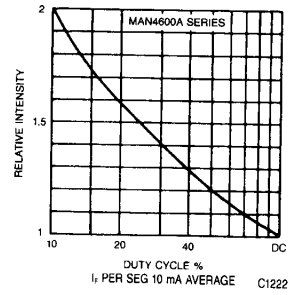

Fig. 11. Relative Luminous Intensity vs. Duty Cycle

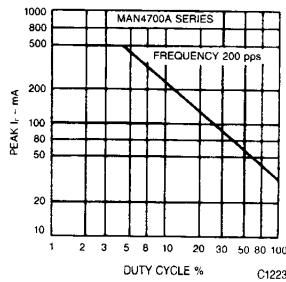

Fig. 12. Max Peak Current vs. Duty Cycle

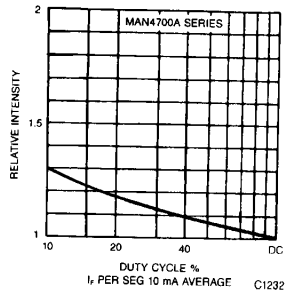

Fig. 13. Relative Luminous Intensity vs. Duty Cycle

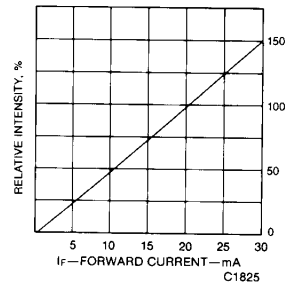

Fig. 14. Relative Luminous Intensity vs. Forward Current