

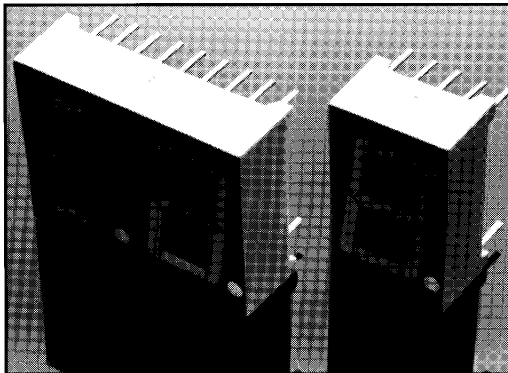

0.560-INCH SEVEN SEGMENT DISPLAYS

HIGH EFFICIENCY GREEN MAN6400 SERIES



DESCRIPTION

The MAN6400 Series is a family of large digits which includes double and single digits. The series features the sculptured font which minimizes "gappiness" at the segment intersections. All models have right hand decimal points and are available in common anode or common cathode configuration. This device has a Grey face and clear segment to enhance ON and OFF contrast.

FEATURES

- High Efficiency Green nitrogen-doped GaAsP on GaP
- Large, easy to read, digits
- Common anode or common cathode models
- Fast switching — excellent for multiplexing
- Low power consumption
- Bold solid segments that are highly legible
- Solid state reliability — long operation life
- Rugged plastic construction
- Directly compatible with integrated circuits
- High brightness with high contrast
- Categorized for Luminous Intensity (See Note 5)
- Wide angle viewing... 150°
- Low forward voltage
- Two-digit package simplifies alignment and assembly

APPLICATIONS

- For industrial and consumer applications such as:
- Digital readout displays
 - Instrument panels
 - Point of sale equipment
 - Digital clocks
 - TV and radios

MODEL NUMBERS

PART NUMBER	COLOR	DESCRIPTION	PACKAGE DRAWING	PIN OUT SPECIFICATION
MAN6410	High Eff. Green	2 Digit; Common Anode; Rt. Hand Decimal	A	A
MAN6440	High Eff. Green	2 Digit; Common Cathode; Rt. Hand Decimal	A	B
MAN6460	High Eff. Green	Single Digit; Common Anode; Rt. Hand Decimal	B	C
MAN6480	High Eff. Green	Single Digit; Common Cathode; Rt. Hand Decimal	B	D

RECOMMENDED OPTICAL FILTERS

For optimum ON and OFF contrast, one of the following filters or equivalents should be used over the display:

DEVICE TYPE	FILTER
MAN6400 Series	Panelgraphic Green 48
	Homalite 100-1440 Green
	Panelgraphic Grey 10
	Homalite 100-1266 Grey



0.560-INCH SEVEN SEGMENT DISPLAYS

ELECTRO-OPTICAL CHARACTERISTICS (Per Diode at 25°C Free Air Temperature Unless Otherwise Specified)					
	MIN.	TYP.	MAX.	UNITS	TEST CONDITIONS
Luminous Intensity, digit average (See Note 1)	510	2200		μ cd	$I_f = 10$ mA
Peak emission wavelength		630		nm	
Spectral line half width		40		nm	
Forward voltage					
Segment			2.5	V	$I_f = 20$ mA
Decimal point			2.5	V	$I_f = 20$ mA
Dynamic resistance					
Segment		26		Ω	$I_f = 20$ mA
Decimal point		26		Ω	$I_f = 20$ mA
Capacitance					
Segment		35		pF	V=0
Decimal point		35		pF	V=0
Reverse current					
Segment			100	μ A	$V_R = 3.0$ V
Decimal point			100	μ A	$V_R = 3.0$ V
Ratio I_c			2:1	—	$I_f = 10$ mA

ABSOLUTE MAXIMUM RATINGS					
	MAN6610 MAN6640	MAN6630 MAN6650	MAN6660 MAN6680	MAN6675 MAN6695	
Power dissipation at 25°C ambient	1200 mW	1050 mW	600 mW	375 mW	
Derate linearly from 50°C	-17 mW/°C	-15.0 mW/°C	-8.6 mW/°C	-5.4 mW/°C	
Storage and operating temperature	-40°C to +85°C	-40°C to +85°C	-40°C to +85°C	-40°C to +85°C	
Continuous forward current					
Total	480 mA	420 mA	240 mA	150 mA	
Per segment	30 mA	30 mA	30 mA	30 mA	
Decimal point	30 mA	30 mA	30 mA	30 mA	
Reverse voltage					
Per segment	6.0 V	6.0 V	6.0 V	6.0 V	
Decimal point	6.0 V	6.0 V	6.0 V	6.0 V	
Soldering time at 260°C (See Notes 3 and 4)	5 sec.	5 sec.	5 sec.	5 sec.	

TYPICAL THERMAL CHARACTERISTICS	
Thermal resistance junction to free air Φ_{JA}	160°C/W
Wavelength temperature coefficient (case temperature)	1.0Å/°C
Forward voltage temperature coefficient	-2.0 mV/°C

- | NOTES | |
|---|--|
| 1. The digit average Luminous Intensity is obtained by summing the Luminous Intensity of each segment and dividing by the total number of segments. Intensity will not vary more than $\pm 33.3\%$ between all segments within a digit. | |
| 2. The curve in Figure 3 is normalized to the brightness at 25°C to indicate the relative efficiency over the operating temperature range. | |
| 3. Leads of the device immersed to 1/16 inch from the body. Maximum device surface temperature is 140°C. | |
| 4. For flux removal, Freon TF, Freon TE, Isoproponal or water may be used up to their boiling points. | |
| 5. All displays are categorized for Luminous Intensity. The Intensity category is marked on each part as a suffix letter to the part number. | |

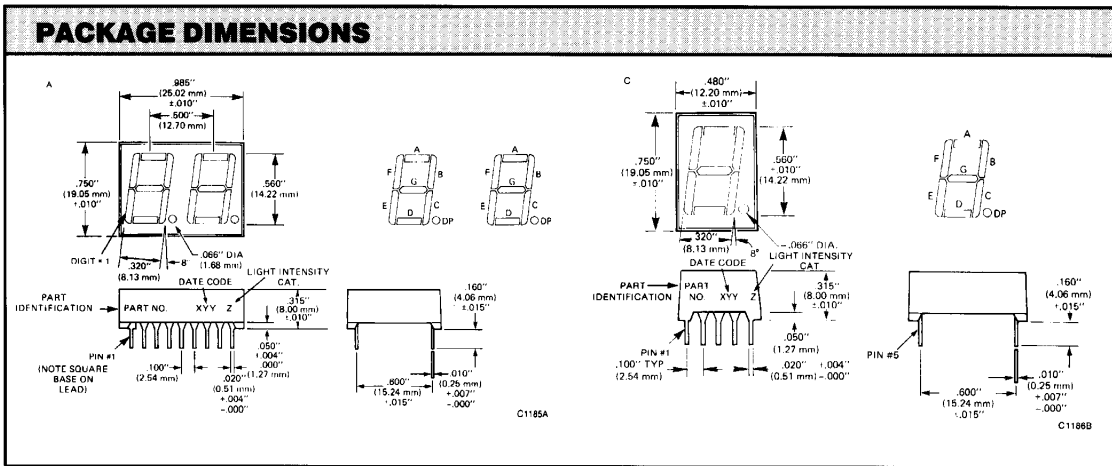

ELECTRICAL CONNECTIONS

Pin No.	ELECTRICAL CONNECTIONS			
	A MAN6410	B MAN6440	C MAN6460	D MAN6480
1	Cathode E 1	Anode E 1	Cathode E	Anode E
2	Cathode D 1	Anode D 1	Cathode D	Anode D
3	Cathode C 1	Anode C 1	Common Anode	Common Cathode
4	Cathode D.P. 1	Anode D.P. 1	Cathode C	Anode C
5	Cathode E 2	Anode E 2	Cathode D.P.	Anode D.P.
6	Cathode D 2	Anode D 2	Cathode B	Anode B
7	Cathode G 2	Anode G 2	Cathode A	Anode A
8	Cathode C 2	Anode C 2	Common Anode	Common Cathode
9	Cathode D.P. 2	Anode D.P. 2	Cathode F	Anode F
10	Cathode B 2	Anode B 2	Cathode G	Anode G
11	Cathode A 2	Anode A 2		
12	Cathode F 2	Anode F 2		
13	Anode Digit 2	Cathode Digit 2		
14	Anode Digit 1	Cathode Digit 1		
15	Cathode B 1	Anode B 1		
16	Cathode A 1	Anode A 1		
17	Cathode G 1	Anode G 1		
18	Cathode F 1	Anode F 1		

TYPICAL CHARACTERISTIC CURVES

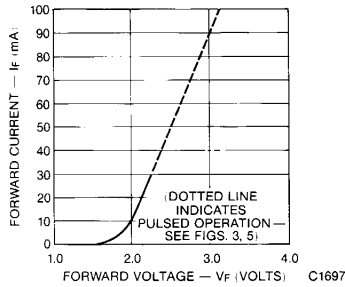

Fig. 1. Forward Current vs. Forward Voltage

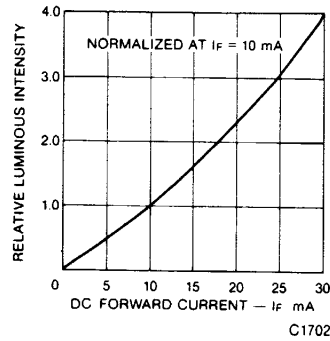

Fig. 2. Relative Luminous Intensity vs. DC Forward Current

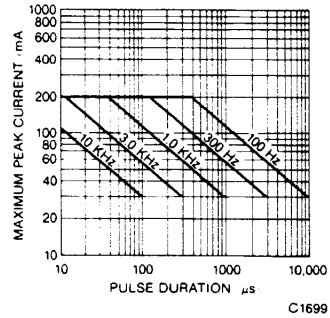

Fig. 3. Maximum Peak Current vs. Pulse Duration

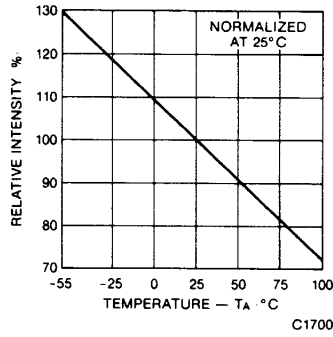

Fig. 4. Relative Luminous Intensity vs. Temperature

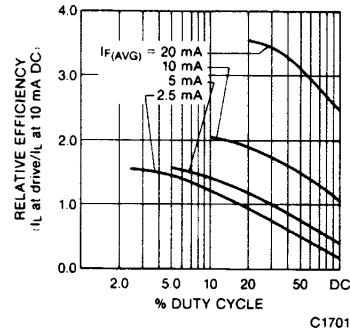

Fig. 5. Relative Efficiency vs. Duty Cycle

INTERNAL CONNECTIONS

