

MAX1626/MAX1627

5V/3.3V or Adjustable, 100% Duty-Cycle, High-Efficiency, Step-Down DC-DC Controllers

General Description

The MAX1626/MAX1627 step-down DC-DC controllers operate over a 2.6V to 16.5V input voltage range. The controllers deliver load current from 1mA to more than 2A. The MAX1626 has pin-selectable 3.3V and 5V outputs. The MAX1627 supports adjustable outputs from 1.3V to 16V.

A unique current-limited, pulse-frequency-modulation (PFM) control scheme operates up to 100% duty cycle, resulting in very low dropout voltage. This control scheme eliminates minimum load requirements and reduces supply current under light loads to 90 μ A (versus 2mA to 10mA for common pulse-width modulation controllers).

The devices are available in a 8-pin SOIC package (-40°C to +85°C) and dice (0°C to +70°C).

Applications

- 5V to 3.3V Green PC Applications
- Battery-Powered Applications
- Handheld Computers
- High-Efficiency Step-Down Regulation
- Low-Cost Notebook Computer Supplies
- Minimum Component DC-DC Converters
- PCMCIA Power Supplies
- PDAs and Other Handheld Devices
- Portable Terminals

Pin Configuration

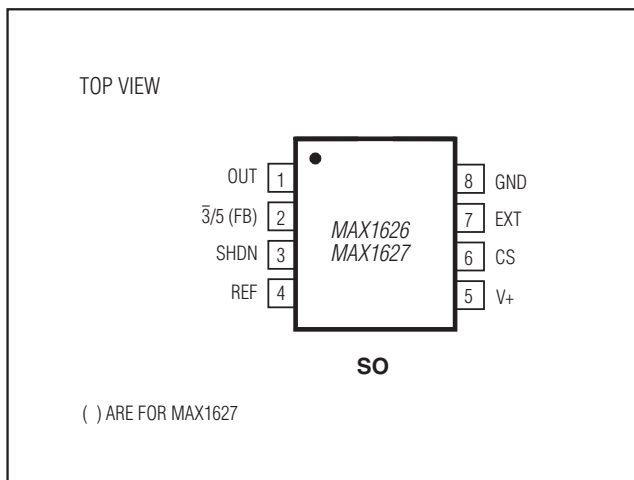

Benefits and Features

- Reduce External Components and Total Cost
 - 300KHz PWM Switching Reduces Component Size
 - Tiny Surface-Mount Inductor
- Reduce Power Dissipation
 - > 90% Efficiency from 3mA to 2A Loads
 - Low Dropout Voltage
 - 100% Maximum Duty Cycle
- Reduce Number of DC-DC Controllers to Stock
 - Wide 2.6V to 16.5V Input Voltage Options
 - Selectable 3.3V and 5V or Adjustable 1.3V to 16V Output Voltage Options
- Reduce System Power Consumption
 - 90 μ A Max Quiescent Current
 - 1 μ A Max Shutdown Current
- Operates Reliably in Adverse Environment
 - Soft-Start Limits Startup Current
 - Current-Limited Control Scheme
- Increase Design Flexibility
 - External P-Channel MOSFET Allows Output Power of > 12.5W

Ordering Information

PART	TEMP RANGE	PIN-PACKAGE
MAX1626C/D	0°C to +70°C	Dice*
MAX1626ESA	-40°C to +85°C	8 SO
MAX1627C/D	0°C to +70°C	Dice*
MAX1627ESA	-40°C to +85°C	8 SO

* Dice are tested at $T_A = +25^\circ\text{C}$.

Typical Operating Circuit

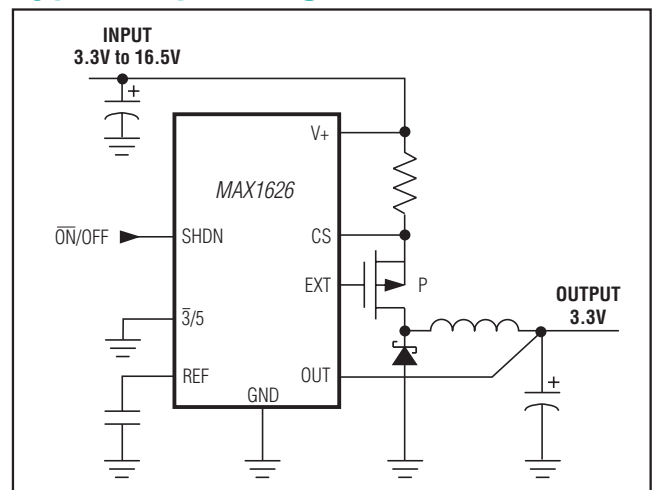

MAX1626/MAX1627

5V/3.3V or Adjustable, 100% Duty-Cycle, High-Efficiency, Step-Down DC-DC Controllers

Supply Voltage, V+ to GND.....-0.3V, +17V
 OUT, FB, $\overline{3}/5$, SHDN, REF, CS, EXT to GND...-0.3V, (V+ + 0.3V)
 Maximum Current at REF (I_{REF}).....15mA
 Maximum Current at EXT (I_{EXT}).....50mA
 Continuous Power Dissipation (T_A = +70°C)
 SO (derate 5.88mW/°C above +70°C).....471mW

Operating Temperature Range
 MAX1626ESA/MAX1627ESA.....-40°C to +85°C
 Storage Temperature Range.....-65°C to +160°C
 Lead Temperature (soldering, 10sec).....+300°C

Stresses beyond those listed under "Absolute Maximum Ratings" may cause permanent damage to the device. These are stress ratings only, and functional operation of the device at these or any other conditions beyond those indicated in the operational sections of the specifications is not implied. Exposure to absolute maximum rating conditions for extended periods may affect device reliability.

Electrical Characteristics

PARAMETER	SYMBOL	CONDITIONS	MIN	TYP	MAX	UNITS
Input Voltage Range	V+		3.0		16.5	V
Supply Current into V+	I+	Operating, no load		70	90	μA
		V+ = SHDN = 16.5V (shutdown)			1	
Undervoltage Lockout				2.7	2.8	V
Output Voltage	V _{OUT}	Circuit of Figure 1, $\overline{3}/5$ = V+ (Note 1)	4.85	5.00	5.15	V
		Circuit of Figure 1, $\overline{3}/5$ = 0V (Note 1)	3.20	3.30	3.40	
OUT Input Current	I _{OUT}	MAX1626, $\overline{3}/5$ = V+, output forced to 5V	24	37	50	μA
FB Threshold Voltage		MAX1627, includes hysteresis	1.27	1.30	1.33	V
FB Leakage Current		MAX1627	0		35	nA
CS Input Current			0		10	μA
CS Threshold Voltage	V _{CS}		85	100	115	mV
SHDN Input Voltage High			1.6			V
SHDN Input Voltage Low					0.4	V
SHDN Input Current		SHDN = 0V or V+			±1	μA
$\overline{3}/5$ Input Voltage High			V+ - 0.5			V
$\overline{3}/5$ Input Voltage Low					0.5	V
$\overline{3}/5$ Leakage Current		$\overline{3}/5$ = 0V or V+			±1	μA
EXT Resistance		V+ = 5V		10		Ω
Minimum EXT Off Time		Output forced to 0V	8	10	12	μs
		Output in regulation	1.5	2.0	2.5	
EXT Duty-Cycle Limit			100			%
Line Regulation		6.0V < V+ < 12.0V, I _{LOAD} = 1A		5		mV/V
Load Regulation		30mA < I _{LOAD} < 2.0A, V+ = 8V		15		mV/A
Reference Voltage	V _{REF}	I _{LOAD} = 0μA	1.27	1.30	1.33	V
REF Load Regulation		0μA ≤ I _{REF} ≤ 100μA		4	10	mV
REF Line Regulation		V+ = 3V to 16.5V, I _{LOAD} = 0μA		10	100	μV/V

Electrical Characteristics

PARAMETER	SYMBOL	CONDITIONS	MIN	TYP	MAX	UNITS
Input Voltage	V+		3.0		16.5	V
Supply Current into V+	I _{OUT}	Operating, no load			100	μA
		V+ = SHDN = 16.5V (shutdown)			2	
Undervoltage Lockout					2.9	V
Output Voltage	V _{OUT}	Circuit of Figure 1, $\overline{3}/5 = V+$	4.80		5.20	V
		Circuit of Figure 1, $\overline{3}/5 = 0V$	3.16		3.44	
OUT Input Current	I _{OUT}	MAX1626, $\overline{3}/5 = V+$, output forced to 5V	24		50	μA
FB Threshold Voltage		MAX1627, includes hysteresis	1.25		1.35	V
FB Leakage Current		MAX1627	0		50	nA
CS Threshold Voltage			80		120	mV
Reference		I _{LOAD} = 0μA	1.25		1.35	V

Note 1: V+ must exceed V_{OUT} to maintain regulation.

Note 2: Specifications from 0°C to -40°C are guaranteed by design, not production tested.

Typical Operating Characteristics

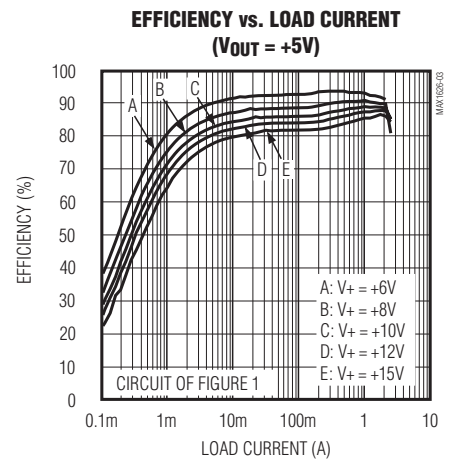
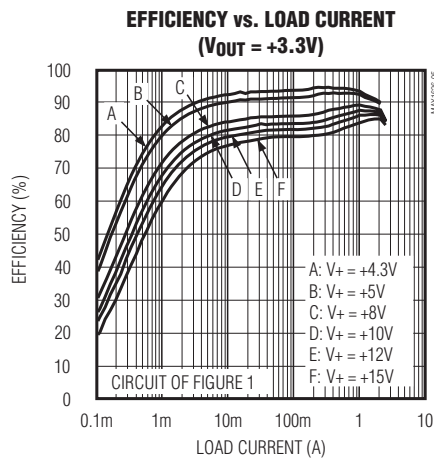
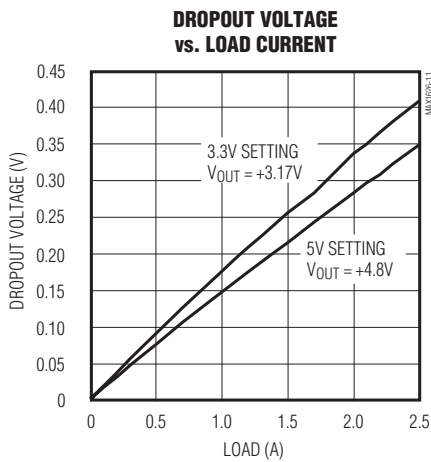

Typical Operating Characteristics (continued)

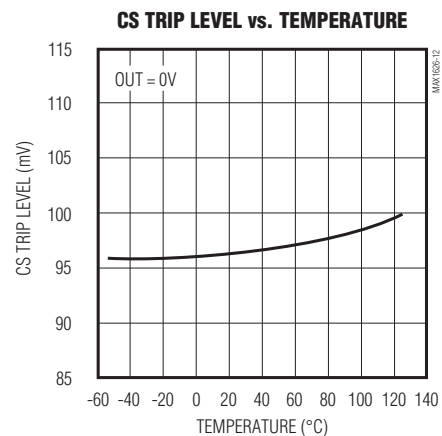
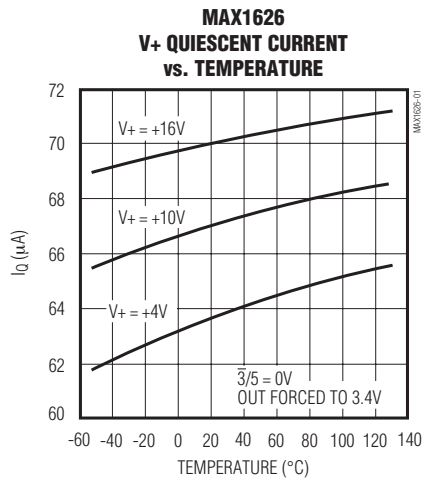
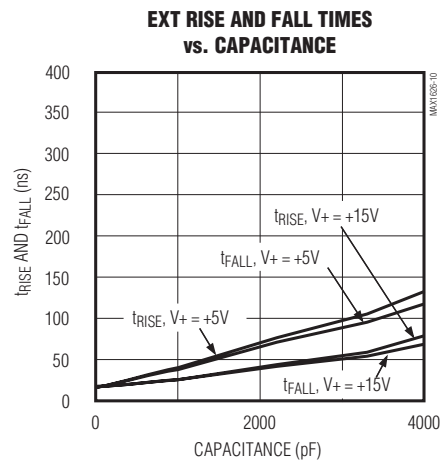
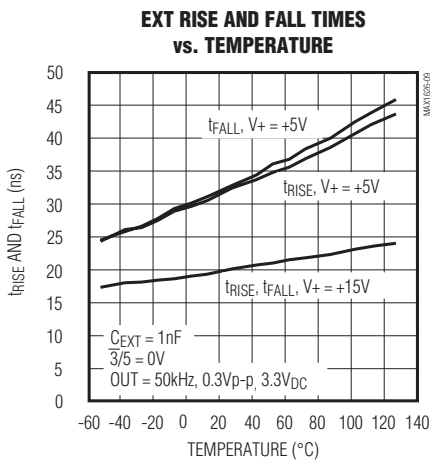
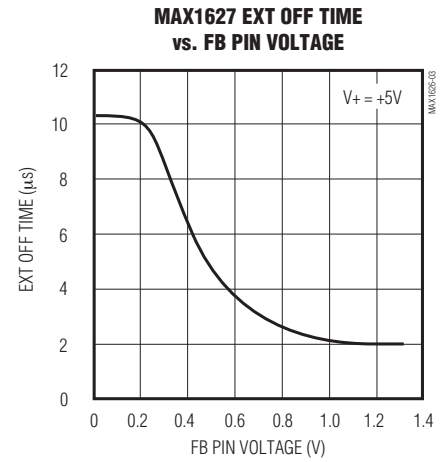
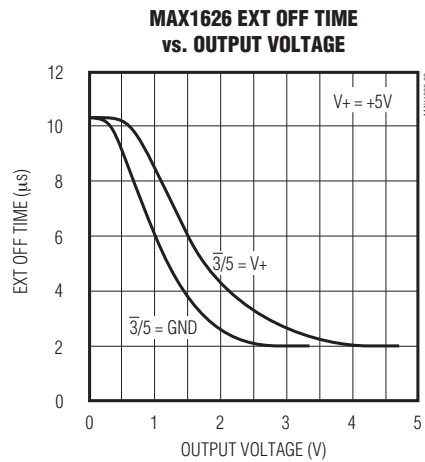
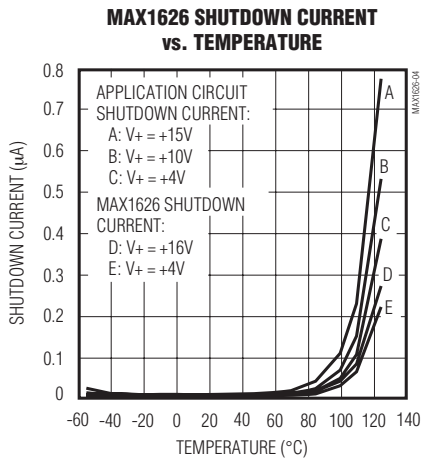

Typical Operating Characteristics (continued)

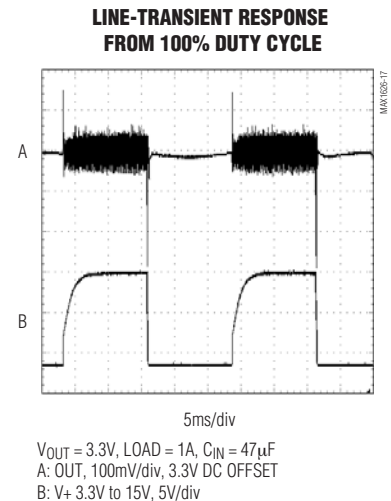
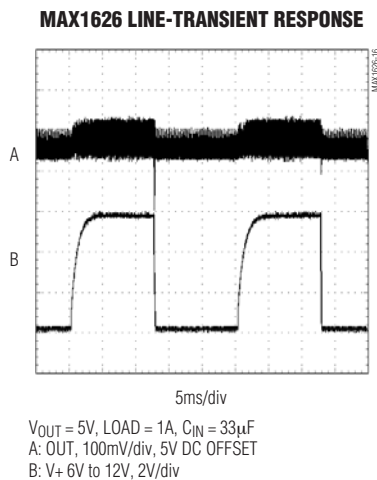
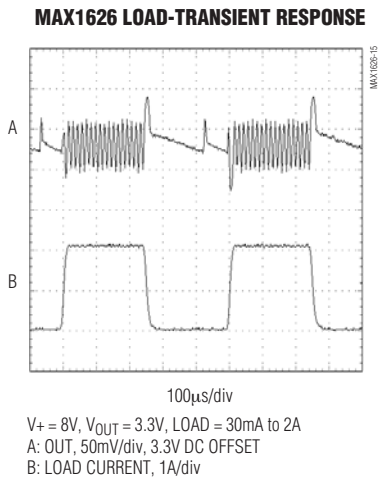
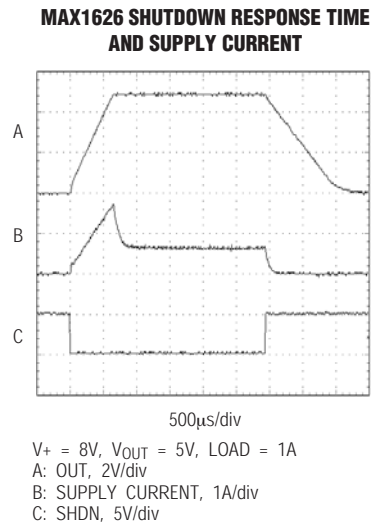
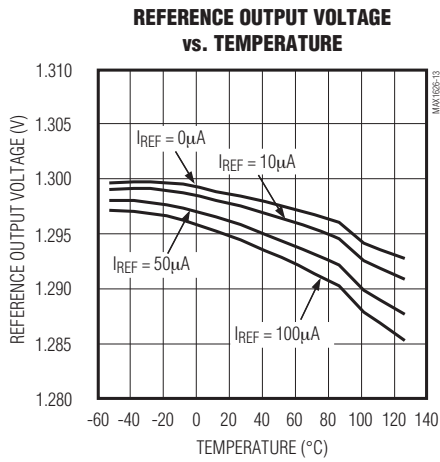

Pin Description

PIN		NAME	FUNCTION
MAX1626	MAX1627		
1	1	OUT	Sense input for fixed 5V or 3.3V output operation. OUT is internally connected to an on-chip voltage divider (MAX1626). It does not supply current. Leave OUT unconnected during adjustable-output operation (MAX1627).
—	2	FB	Feedback Input for adjustable-output operation. Connect to an external voltage divider between the output and GND (see the <i>Setting the Output Voltage</i> section).
2	—	$\bar{3}/5$	3.3V or 5V Selection. Output voltage is set to 3.3V when this pin is low or 5V when it is high.
3	3	SHDN	Active-High Shutdown Input. Device is placed in shutdown when SHDN is driven high. In shutdown mode, the reference, output, and external MOSFET are turned off. Connect to GND for normal operation.
4	4	REF	1.3V Reference Output. Can source 100 μ A. Bypass with 0.1 μ F.
5	5	V+	Positive Supply Input. Bypass with 0.47 μ F.
6	6	CS	Current-Sense Input. Connect current-sense resistor between V+ and CS. External MOSFET is turned off when the voltage across the resistor equals the current-limit trip level (around 100mV).
7	7	EXT	Gate Drive for External P-Channel MOSFET. EXT swings between V+ and GND.
8	8	GND	Ground

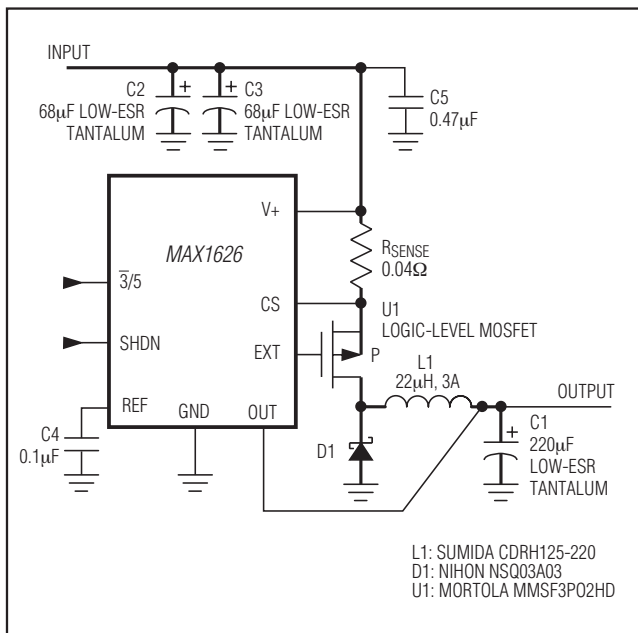

Figure 1. MAX1626 Typical Operating Circuit

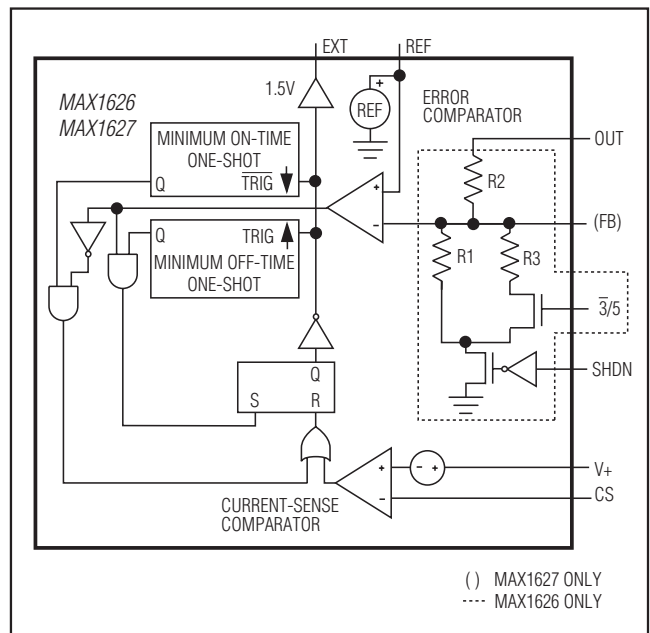

Figure 2. Simplified Functional Diagram

Detailed Description

The MAX1626/MAX1627 are step-down DC-DC controllers designed primarily for use in portable computers and battery-powered devices. Using an external MOSFET and current-sense resistor allows design flexibility and the improved efficiencies associated with high-performance P-channel MOSFETs. A unique, current-limited, pulse-frequency-modulated (PFM) control scheme gives these devices excellent efficiency over load ranges up to three decades, while drawing around 90 μ A under no load. This wide dynamic range optimizes the MAX1626/MAX1627 for battery-powered applications, where load currents can vary considerably as individual circuit blocks are turned on and off to conserve energy. Operation to a 100% duty cycle allows the lowest possible dropout voltage, extending battery life. High switching frequencies and a simple circuit topology minimize PC board area and component costs. Figure 1 shows a typical operating circuit for the MAX1626.

PFM Control Scheme

The MAX1626/MAX1627 use a proprietary, third-generation, current-limited PFM control scheme. Improvements include a reduced current-sense threshold and operation to a 100% duty cycle. These devices pulse only as needed to maintain regulation, resulting in a variable switching frequency that increases with the load. This eliminates the current drain associated with constant-frequency pulse-width-modulation (PWM) controllers, caused by switching the MOSFET unnecessarily.

When the output voltage is too low, the error comparator sets a flip-flop, which turns on the external P-channel MOSFET and begins a switching cycle (Figures 1 and 2). As shown in Figure 3, current through the inductor ramps up linearly, storing energy in a magnetic field while dumping charge into an output capacitor and servicing the load. When the MOSFET is turned off, the magnetic field collapses, diode D1 turns on, and the current through the inductor ramps back down, transferring the stored energy to the output capacitor and load. The output capacitor stores energy when the inductor current is high and releases it when the inductor current is low.

The MAX1626/MAX1627 use a unique feedback and control system to govern each pulse. When the output voltage is too low, the error comparator sets a flip-flop, which turns on the external P-channel MOSFET. The MOSFET turns off when the current-sense threshold is exceeded or when the output voltage is in regulation. A one-shot enforces a 2 μ s minimum on-time, except in current limit. The flip-flop resets when the MOSFET

turns off. Otherwise the MOSFET remains on, allowing a duty cycle of up to 100%. This feature ensures the lowest possible dropout. Once the MOSFET is turned off, the minimum off-time comparator keeps it off. The minimum off-time is normally 2 μ s, except when the output is significantly out of regulation. If the output is low by 30% or more, the minimum off-time increases, allowing soft-start. The error comparator has 0.5% hysteresis for improved noise immunity.

In the MAX1626, the $\bar{3}/5$ pin selects the output voltage (Figure 2). In the MAX1627, external feedback resistors at FB adjust the output.

Operating Modes

When delivering low and medium output currents, the MAX1626/MAX1627 operate in discontinuous-conduction mode. Current through the inductor starts at zero, rises as high as the peak current limit set by the current-sense resistor, then ramps down to zero during each cycle (Figure 3). Although efficiency is still excellent, output ripple increases and the switch waveform exhibits ringing. This ringing occurs at the resonant frequency of the inductor and stray capacitance, due to residual energy trapped in the core when the commutation diode (D1 in Figure 1) turns off. It is normal and poses no operational problems.

When delivering high output currents, the MAX1626/MAX1627 operate in continuous-conduction mode (Figure 4). In this mode, current always flows through the inductor and never ramps to zero. The control circuit adjusts the switch duty cycle to maintain regulation without exceeding the peak switching current set by the current-sense resistor. This provides reduced output ripple and high efficiency.

100% Duty Cycle and Dropout

The MAX1626/MAX1627 operate with a duty cycle up to 100%. This feature extends usable battery life by turning the MOSFET on continuously when the supply voltage approaches the output voltage. This services the load when conventional switching regulators with less than 100% duty cycle would fail. Dropout voltage is defined as the difference between the input and output voltages when the input is low enough for the output to drop out of regulation. Dropout depends on the MOSFET drain-to-source on-resistance, current-sense resistor, and inductor series resistance, and is proportional to the load current:

$$\text{Dropout Voltage} = I_{\text{OUT}} \times [R_{\text{DS(ON)}} + R_{\text{SENSE}} + R_{\text{INDUCTOR}}]$$

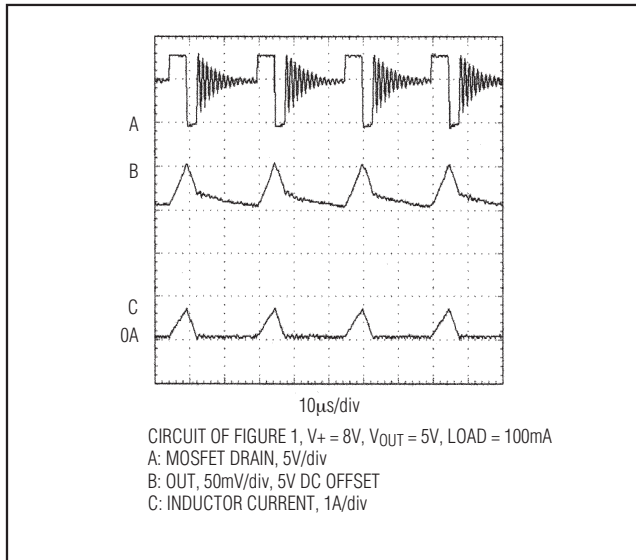

Figure 3. Discontinuous-Conduction Mode, Light-Load-Current Waveform

EXT Drive Voltage Range

EXT swings from V_+ to GND and provides the gate drive for an external P-channel power MOSFET. A higher supply voltage increases the gate drive to the MOSFET and reduces on-resistance ($R_{DS(ON)}$). See *External Switching Transistor* section.

Quiescent Current

The device's typical quiescent current is $70\mu A$. However, actual applications draw additional current to supply MOSFET switching currents, OUT pin current, or external feedback resistors (if used), and both the diode and capacitor leakage currents. For example, in the circuit of Figure 1, with V_+ at 7V and V_{OUT} at 5V, typical no-load supply current for the entire circuit is $84\mu A$. When designing a circuit for high-temperature operation, select a Schottky diode with low reverse leakage.

Shutdown Mode

When SHDN is high, the device enters shutdown mode. In this mode, the feedback and control circuit, reference, and internal biasing circuitry are turned off. EXT goes high, turning off the external MOSFET. The shutdown supply current drops to less than $1\mu A$. SHDN is a logic-level input. Connect SHDN to GND for normal operation.

Reference

The 1.3V reference is suitable for driving external loads, such as an analog-to-digital converter. It has a guaranteed 10mV maximum load regulation while sourcing load currents up to $100\mu A$. The reference is turned off during

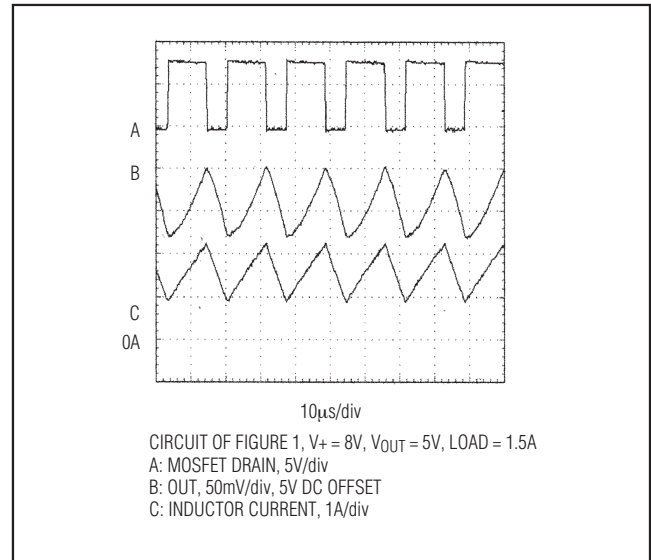

Figure 4. Continuous-Conduction Mode, Heavy-Load-Current Waveform

shutdown. Bypass the reference with $0.1\mu F$ for normal operation. Place the bypass capacitor within 0.2 inches (5mm) of REF, with a direct trace to GND (Figure 7).

Soft-Start

Soft-start reduces stress and transient voltage slumps on the power source. When the output voltage is near ground, the minimum off-time is lengthened to limit peak switching current. This compensates for reduced negative inductor current slope due to low output voltages.

Design Information

Setting the Output Voltage

The MAX1626's output voltage can be selected to 3.3V or 5V under logic control by using the $\overline{3/5}$ pin. The $\overline{3/5}$ pin requires less than 0.5V to ensure a 3.3V output, or more than $(V_+ - 0.5)V$ to guarantee a 5V output. The voltage sense pin (OUT) must be connected to the output for the MAX1626.

The MAX1627's output voltage is set using two resistors, R2 and R3 (Figure 5), which form a voltage divider between the output and GND. R2 is given by:

$$R2 = R3 \times \left(\frac{V_{OUT}}{V_{REF}} - 1 \right)$$

where $V_{REF} = 1.3V$. Since the input bias current at FB has a maximum value of 50nA, large values ($10k\Omega$ to $200k\Omega$) can be used for R3 with no significant accuracy

MAX1626/MAX1627

5V/3.3V or Adjustable, 100% Duty-Cycle, High-Efficiency, Step-Down DC-DC Controllers

loss. For 1% error, the current through R2 should be at least 100 times FB's input bias current. Capacitor CR2 is used to compensate the MAX1627 for even switching. Values between 0pF and 330pF work for many applications. See the *Stability and MAX1627 Feedback Compensation* section for details.

Current-Sense-Resistor Selection

The current-sense comparator limits the peak switching current to V_{CS}/R_{SENSE} , where R_{SENSE} is the value of the current-sense resistor and V_{CS} is the current-sense threshold. V_{CS} is typically 100mV, but can range from 85mV to 115mV. Minimizing the peak switching current will increase efficiency and reduce the size and cost of external components. However, since available output current is a function of the peak switching current, the peak current limit must not be set too low.

Set the peak current limit above 1.3 times the maximum load current by setting the current-sense resistor to:

$$R_{CS} = \frac{V_{CS(MIN)}}{1.3 \times I_{OUT(MAX)}}$$

Alternatively, select the current-sense resistor for 5V and 3.3V output applications using the current-sense resistor graphs in Figures 6a and 6b. The current-sense resistor's power rating should be 20% higher than:

$$R_{POWER RATING (W)} = \frac{V_{CS(MAX)}^2}{R_{CS}}$$

Standard wire-wound resistors have an inductance high enough to degrade performance, and are not rec-

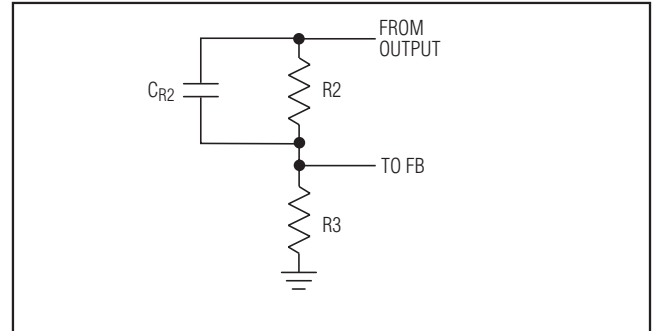

Figure 5. Adjustable-Output Operation Using the MAX1627

ommended. Surface-mount (chip) resistors have very little inductance and are well suited for use as current-sense resistors. Power metal-strip resistors feature 1/2W and 1W power dissipation, 1% tolerance, and inductance below 5nH. Resistance values between 10mΩ and 500mΩ are available.

Inductor Selection

The essential parameters for inductor selection are inductance and current rating. The MAX1626/MAX1627 operate with a wide range of inductance values. In many applications, values between 10μH and 68μH take best advantage of the controller's high switching frequency.

Calculate the minimum inductance value as follows:

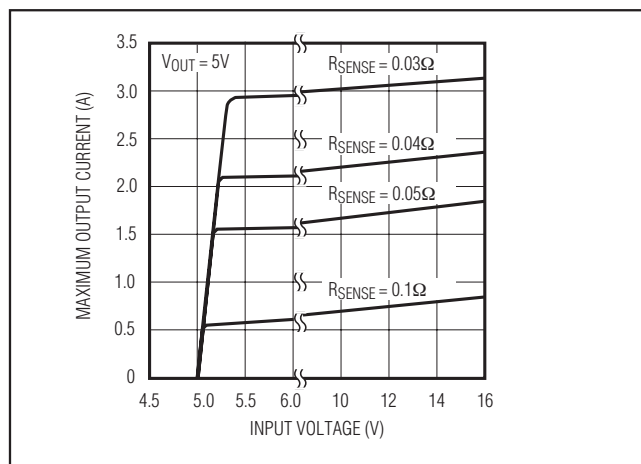

Figure 6a. MAX1626 5V-Operation Current-Sense Resistor Graph

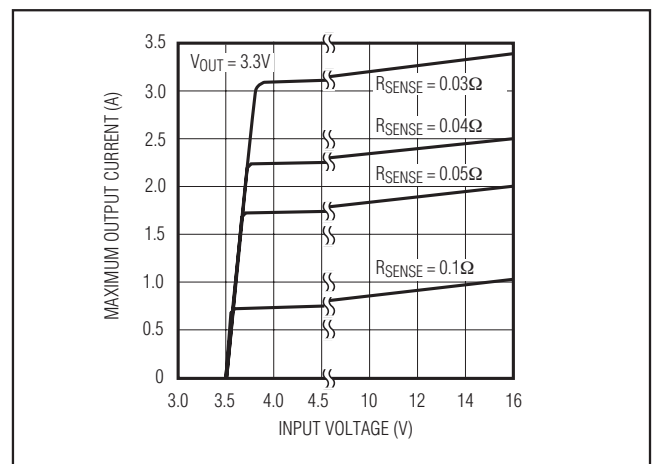

Figure 6b. MAX1626 3.3V-Operation Current-Sense Resistor Graph

where 2µs is the minimum on-time. Inductor values between two and six times L(MIN) are recommended. With high inductor values, the MAX1626/MAX1627 will begin continuous-conduction operation at a lower fraction of the full load (see *Detailed Description*). Low-value inductors may be smaller and less expensive, but they result in greater peak current overshoot due to current-sense comparator propagation delay. Peak-current overshoot reduces efficiency and could cause the external components' current ratings to be exceeded.

The inductor's saturation and heating current ratings must be greater than the peak switching current to prevent overheating and core saturation. Saturation occurs when the inductor's magnetic flux density reaches the maximum level the core can support, and inductance starts to fall. The heating current rating is the maximum DC current the inductor can sustain without overheating. The peak switching current is the sum of the current limit set by the current-sense resistor and overshoot during current-sense comparator propagation delay.

$$I_{PEAK} = \frac{V_{CS}}{R_{CS}} + \frac{(V_+ - V_{OUT}) \times 1\mu s}{L}$$

1µs is the worst-case current-sense comparator propagation delay.

Inductors with a core of ferrite, Kool Mu™, METGLAS™, or equivalent, are recommended. Powder iron cores are not recommended for use with high switching frequencies. For optimum efficiency, the inductor wind-

KOOL Mu is a trademark of Magnetics.

METGLAS is a trademark of Allied Signal.

Table 1. Component Selection Guide

PRODUCTION METHOD	INDUCTORS	CAPACITORS	DIODES	CURRENT-SENSE RESISTORS	MOSFETS
Surface Mount	Sumida CDRH125-470 (1.8A) CDRH125-220 (2.2A) Coilcraft DO3316-473 (1.6A) DO3340-473 (3.8A)	AVX TPS series Sprague 595D series	Motorola MBRS340T3 Nihon NSQ series	Dale WSL series IRC LRC series	Siliconix Little Foot series Motorola medium-power surface-mount products
Miniature Through-Hole	Sumida RCH875-470M (1.3A)	Sanyo OS-CON series low-ESR organic semiconductor		IRC OAR series	Motorola
Low-Cost Through-Hole	Coilcraft PCH-45-473 (3.4A)	Nichicon PL series low-ESR electrolytics United Chemi-Con LXF series	Motorola 1N5817 to 1N5823		Motorola TMOS power MOSFETs

ings' resistance should be on the order of the current-sense resistance. If necessary, use a toroid, pot-core, or shielded-core inductor to minimize radiated noise. Table 1 lists inductor types and suppliers for various applications.

External Switching Transistor

The MAX1626/MAX1627 drive P-channel enhancement-mode MOSFETs. The EXT output swings from GND to the voltage at V+. To ensure the MOSFET is fully on, use logic-level or low-threshold MOSFETs when the input voltage is less than 8V. Tables 1 and 2 list recommended suppliers of switching transistors.

Four important parameters for selecting a P-channel MOSFET are drain-to-source breakdown voltage, current rating, total gate charge (Qg), and RDS(ON). The drain-to-source breakdown voltage rating should be at least a few volts higher than V+. Choose a MOSFET with a maximum continuous drain current rating higher than the peak current limit:

$$I_{D(MAX)} \geq I_{LIM(MAX)} = \frac{V_{CS(MAX)}}{R_{SENSE}}$$

The Qg specification should be less than 100nC to ensure fast drain voltage rise and fall times, and reduce power losses during transition through the linear region. Qg specifies all of the capacitances associated with charging the MOSFET gate. EXT pin rise and fall times vary with different capacitive loads, as shown in the *Typical Operating Characteristics*. RDS(ON) should be as low as practical to reduce power losses while the MOSFET is on. It should be equal to or less than the current-sense resistor.

Table 2. Component Suppliers

COMPANY		PHONE	FAX
AVX	USA	(803) 946-0690 or (800) 282-4975	(803) 626-3123
Coilcraft	USA	(847) 639-6400	(847) 639-1469
Coiltronics	USA	(516) 241-7876	(516) 241-9339
Dale	USA	(605) 668-4131	(605) 665-1627
International Rectifier	USA	(310) 322-3331	(310) 322-3332
IRC	USA	(512) 992-7900	(512) 992-3377
Motorola	USA	(602) 303-5454	(602) 994-6430
Nichicon	USA Japan	(847) 843-7500 81-7-5231-8461	(847) 843-2798 81-7-5256-4158
Nihon	USA Japan	(805) 867-2555 81-3-3494-7411	(805) 867-2698 81-3-3494-7414
Sanyo	USA Japan	(619) 661-6835 81-7-2070-6306	(619) 661-1055 81-7-2070-1174
Siliconix	USA	(408) 988-8000 or (800) 554-5565	(408) 970-3950
Sprague	USA	(603) 224-1961	(603) 224-1430
Sumida	USA Japan	(847) 956-0666 81-3-3607-5111	(847) 956-0702 81-3-3607-5144
United Chemi-Con	USA	(714) 255-9500	(714) 255-9400

Diode Selection

The MAX1626/MAX1627's high switching frequency demands a high-speed rectifier. Schottky diodes, such as the 1N5817–1N5822 family or surface-mount equivalents, are recommended. Ultra-high-speed rectifiers with reverse recovery times around 50ns or faster, such as the MUR series, are acceptable. Make sure that the diode's peak current rating exceeds the peak current limit set by R_{SENSE} , and that its breakdown voltage exceeds V_+ . Schottky diodes are preferred for heavy loads due to their low forward voltage, especially in low-voltage applications. For high-temperature applications, some Schottky diodes may be inadequate due to their high leakage currents. In such cases, ultra-high-speed rectifiers are recommended, although a Schottky diode with a higher reverse voltage rating can often provide acceptable performance.

Capacitor Selection

Choose filter capacitors to service input and output peak currents with acceptable voltage ripple. Equivalent series resistance (ESR) in the capacitor is a

major contributor to output ripple, so low-ESR capacitors are recommended. Sanyo OS-CON capacitors are best, and low-ESR tantalum capacitors are second best. Low-ESR aluminum electrolytic capacitors are tolerable, but do not use standard aluminum electrolytic capacitors.

Voltage ripple is the sum of contributions from ESR and the capacitor value:

$$V_{RIPPLE} \approx V_{RIPPLE,ESR} + V_{RIPPLE,C}$$

To simplify selection, assume initially that two-thirds of the ripple results from ESR and one-third results from capacitor value. Voltage ripple as a consequence of ESR is approximated by:

$$V_{RIPPLE,ESR} \approx (R_{ESR})(I_{PEAK})$$

Estimate input and output capacitor values for given voltage ripple as follows:

$$C_{IN} = \frac{\frac{1}{2}LI_{\Delta L}^2}{V_{RIPPLE,CIN}V_{IN}}$$

$$C_{OUT} = \frac{\frac{1}{2}LI_{\Delta L}^2}{V_{RIPPLE,COU}V_{OUT}} \left(\frac{V_{IN}}{V_{IN} - V_{OUT}} \right)$$

where $I_{\Delta L}$ is the change in inductor current (around $0.5I_{PEAK}$ under moderate loads).

These equations are suitable for initial capacitor selection; final values should be set by testing a prototype or evaluation kit. When using tantalum capacitors, use good soldering practices to prevent excessive heat from damaging the devices and increasing their ESR. Also, ensure that the tantalum capacitors' surge-current ratings exceed the start-up inrush and peak switching currents.

Pursuing output ripple lower than the error comparator's hysteresis (0.5% of the output voltage) is not practical, since the MAX1626/MAX1627 will switch as needed, until the output voltage crosses the hysteresis threshold. Choose an output capacitor with a working voltage rating higher than the output voltage.

The input filter capacitor reduces peak currents drawn from the power source and reduces noise and voltage ripple on V_+ and CS, caused by the circuit's switching action. Use a low-ESR capacitor. Two smaller-value low-ESR capacitors can be connected in parallel for lower cost. Choose input capacitors with working voltage ratings higher than the maximum input voltage.

MAX1626/MAX1627

Place a surface-mount ceramic capacitor very close to $V+$ and GND, as shown in Figure 7. This capacitor bypasses the MAX1626/MAX1627, and prevents spikes and ringing on the power source from obscuring the current feedback signal and causing jitter. $0.47\mu\text{F}$ is recommended. Increase the value as necessary in high-power applications.

Bypass REF with $0.1\mu\text{F}$. This capacitor should be placed within 0.2 inches (5mm) of the IC, next to REF, with a direct trace to GND (Figure 7).

Layout Considerations

High-frequency switching regulators are sensitive to PC board layout. Poor layout introduces switching noise into the current and voltage feedback signals, resulting in jitter, instability, or degraded performance. The current-sense resistor must be placed within 0.2 inches (5mm) of the controller IC, directly between $V+$ and CS. Place voltage feedback resistors (MAX1627) next to the FB pin (no more than 0.2") rather than near the output. Place the $0.47\mu\text{F}$ input and $0.1\mu\text{F}$ reference bypass capacitors within 0.2 inches (5mm) of $V+$ and REF, and route directly to GND. Figure 7 shows the recommended layout and routing for these components.

High-power traces, highlighted in the *Typical Operating Circuit* (Figure 1), should be as short and as wide as possible. The supply-current loop (formed by C2, C3, RSENSE, U1, L1, and C1) and commutation-current loop (D1, L1, and C1) should be as tight as possible to reduce radiated noise. Place the anode of the commutation diode (D1) and the ground pins of the input and output filter capacitors close together, and route them to a common "star-ground" point. Place components and route ground paths so as to prevent high currents from causing large voltage gradients between the ground pin of the output filter capacitor, the controller IC, and the reference bypass capacitor. Keep the extra copper on the component and solder sides of the PC board, rather than etching it away, and connect it to ground for use as a pseudo-ground plane. Refer to the MAX1626 Evaluation Kit manual for a two-layer PC board example.

Stability and MAX1627 Feedback Compensation

Use proper PC board layout and recommended external components to ensure stable operation. In one-shot, sequenced PFM DC-DC converters, instability is manifested as "Motorboat Instability." It is usually caused by excessive noise on the current or voltage feedback signals, ground, or reference, due to poor PC board design or external component selection. Motorboat instability is characterized by grouped switching pulses with large gaps and excessive low-

5V/3.3V or Adjustable, 100% Duty-Cycle, High-Efficiency, Step-Down DC-DC Controllers

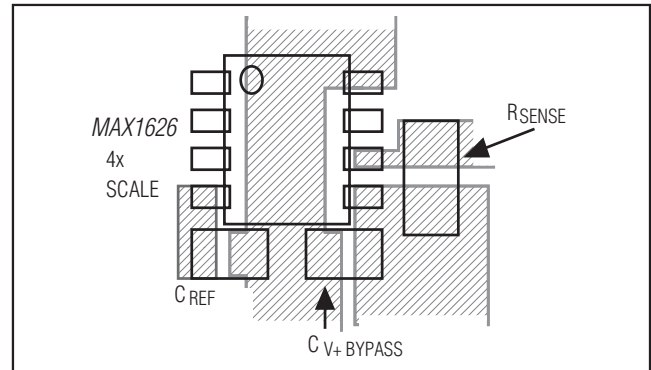

Figure 7. Recommended Placement and Routing of the Current-Sense Resistor, $0.1\mu\text{F}$ Reference, and $0.47\mu\text{F}$ Input Bypass Capacitors

frequency output ripple. It is normal to see some grouped switching pulses during the transition from discontinuous to continuous current mode. This effect is associated with small gaps between pulse groups and output ripple similar to or less than that seen during no-load conditions.

Instability can also be caused by excessive stray capacitance on FB when using the MAX1627. Compensate for this by adding a 0pF to 330pF feed-forward capacitor across the upper feedback resistor (R2 in Figure 5).

MAX1626/MAX1627 vs. MAX1649/MAX1651 vs. MAX649/MAX651

The MAX1626/MAX1627 are specialized, third-generation upgrades to the MAX649/MAX651 step-down controllers. They feature improved efficiency, a reduced current-sense threshold (100mV), soft-start, and a 100% duty cycle for lowest dropout. The MAX649/ MAX651 have a two-step ($210\text{mV}/110\text{mV}$) current-sense threshold. The MAX1649/MAX1651 are second-generation upgrades with a 96.5% maximum duty cycle for improved dropout performance and a reduced current-sense threshold (110mV) for higher efficiency, especially at low input voltages. The MAX1649/ MAX1651 are preferable for special applications where a 100% duty cycle is undesirable, such as flyback and SEPIC circuits.

Since the MAX1626's pinout is similar to those of the MAX649 and MAX1649 family parts, the MAX1626 can be substituted (with minor external component value changes) into fixed-output mode applications, provided the PC board layout is adequate. The MAX1627 can also be substituted when MAX649 or MAX1649 family parts are used in adjustable mode, but the feedback resistor values must be changed, since the MAX1627 has a lower reference voltage (1.3V vs. 1.5V). Reduce

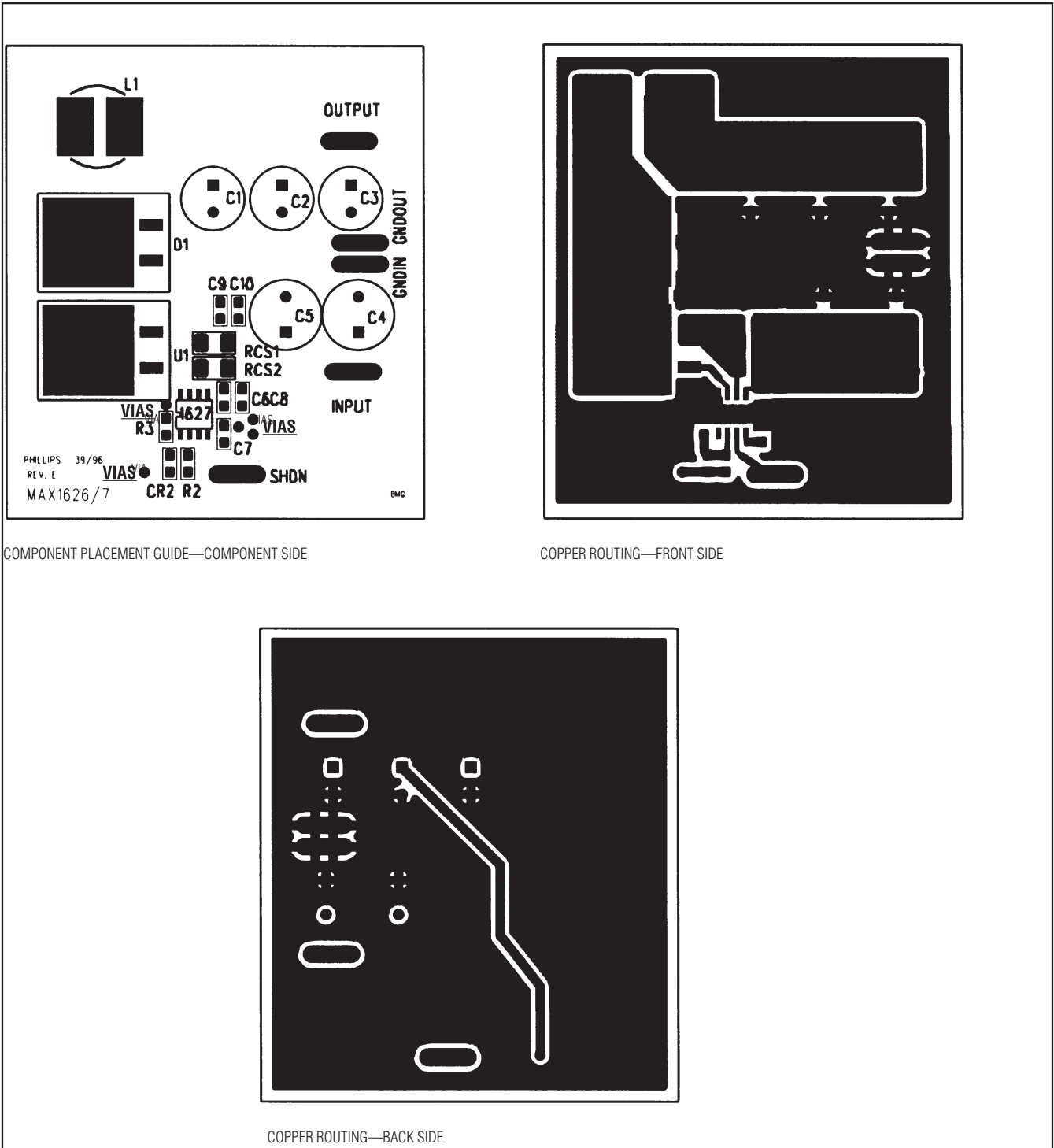
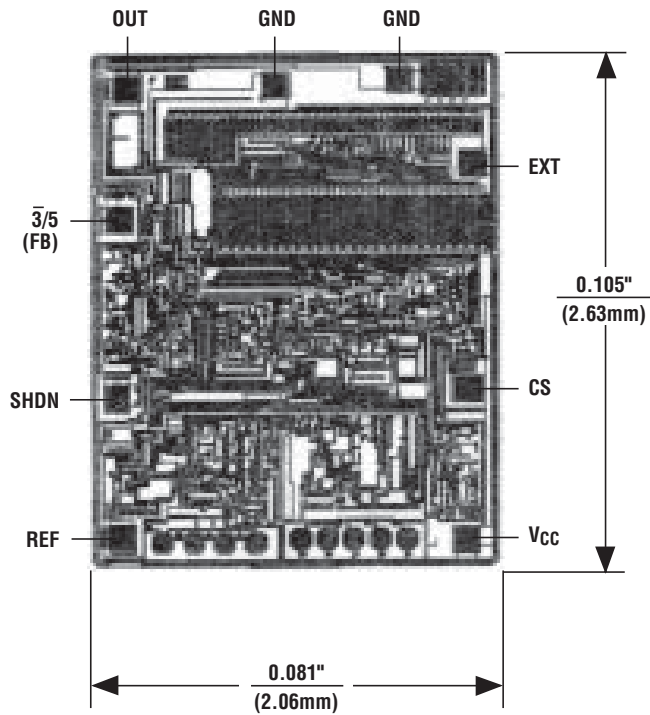

Figure 11. Recommended PCB Design for 6A Step-Down Converter

Chip Topography



() ARE FOR MAX1627
 TRANSISTOR COUNT: 375
 SUBSTRATE CONNECTED TO V+

Package Information

For the latest package outline information and land patterns (footprints), go to www.maximintegrated.com/packages. Note that a "+", "#", or "-" in the package code indicates RoHS status only. Package drawings may show a different suffix character, but the drawing pertains to the package regardless of RoHS status.

PACKAGE TYPE	PACKAGE CODE	OUTLINE NO.	LAND PATTERN NO.
8 SO	S8-4	21-0041	90-0096

Revision History

REVISION NUMBER	REVISION DATE	DESCRIPTION	PAGES CHANGED
0	6/96	Initial release	—
1	5/15	Updated <i>General Description, Applications, and Benefits and Features</i> sections	1

For pricing, delivery, and ordering information, please contact Maxim Direct at 1-888-629-4642, or visit Maxim Integrated's website at www.maximintegrated.com.

Maxim Integrated cannot assume responsibility for use of any circuitry other than circuitry entirely embodied in a Maxim Integrated product. No circuit patent licenses are implied. Maxim Integrated reserves the right to change the circuitry and specifications without notice at any time. The parametric values (min and max limits) shown in the Electrical Characteristics table are guaranteed. Other parametric values quoted in this data sheet are provided for guidance.