

# MAX17135 Evaluation System

## Evaluates: MAX17135

### General Description

The MAX17135 evaluation system (EV system) consists of the MAX17135 evaluation kit (EV kit) and the Maxim CMAXQUSB+ command module. Windows XP®, Windows Vista®, and Windows® 7-compatible software is also available for use with the EV system and can be downloaded from [www.maxim-ic.com/evkitsoftware](http://www.maxim-ic.com/evkitsoftware).

The EV kit is a fully assembled and tested surface-mount PCB that provides a complete power-management solution for E-paper displays. The EV kit contains source- and gate-driver power supplies, a high-speed VCOM amplifier, and a temperature sensor.

The EV kit operates from a 2.7V to 5.5V DC supply voltage. The step-up switching regulator (POS) is configured for a 15V output that provides 200mA. The inverting buck-boost converter (NEG) generates a -15V output that provides 200mA. The gate-driver power supplies consist of regulated charge pumps that generate 22V (GVDD) and -20V (GVEE) and can deliver up to 20mA each. The EV kit also features a digitally adjustable VCOM amplifier and the option for internal/external temperature sensing.

The CMAXQUSB+ command module provides the I<sup>2</sup>C/SMBus interface and is connected to the computer through the universal serial bus (USB) port. The EV kit also includes Windows XP-, Windows Vista-, and Windows 7-compatible software that provides a simple graphical user interface (GUI) for exercising the features of the IC.

*Windows, Windows XP, and Windows Vista are registered trademarks of Microsoft Corp.*

### Features

- ◆ 2.7V to 5.5V Input Range
- ◆ 1MHz Boost and Inverted Buck-Boost Switching Frequency
- ◆ Output Voltages
  - 15V Output at 200mA (Step-Up Switching Regulator)
  - 15V Output at 200mA (Inverting Buck-Boost Switching Regulator)
  - 22V Output at 20mA (Positive Charge Pump)
  - 20V Output at 20mA (Negative Charge Pump)
- ◆ Measures Remote Diode Temperature
- ◆ Digitally Programmable Op-Amp Output Voltage
- ◆ Windows XP-, Windows Vista-, and Windows 7-Compatible Software
- ◆ Proven PCB Layout
- ◆ Fully Assembled and Tested

*Ordering Information appears at end of data sheet.*

### Component Lists

#### MAX17135 EV System

PART	QTY	DESCRIPTION
MAX17135EVKIT#	1	MAX17135 EV kit
CMAXQUSB+	1	I <sup>2</sup> C/SMBus interface command module

#### MAX17135 EV Kit

DESIGNATION	QTY	DESCRIPTION
C1, C5	2	10μF ±10%, 6.3V X7R ceramic capacitors (0805) Murata GRM21BR70J106K TDK C2012X7R0J106K
C2, C3, C4, C6, C16, C18, C28	7	4.7μF ±10%, 25V X7R ceramic capacitors (1206) Murata GRM31CR71E475KA88L
C7, C8	2	0.1μF ±10%, 16V X7R ceramic capacitors (0402) Murata GRM155R71C104K TDK C1005X7R1C104K

# MAX17135 Evaluation System

## Evaluates: MAX17135

### Component Lists (continued)

#### MAX17135 EV Kit (continued)

DESIGNATION	QTY	DESCRIPTION
C9, C12, C17, C24, C25	0	Not installed, ceramic capacitors (0603)
C10, C11, C15	3	1 $\mu$ F $\pm$ 10%, 25V X7R ceramic capacitors (0603) Murata GRM188R61E105K TDK C1608X5R1E105K
C13	1	1 $\mu$ F $\pm$ 10%, 25V X7R ceramic capacitor (0805) Murata GRM21BR71E105K TDK C2012X7R1E105K
C14, C20, C26	3	0.1 $\mu$ F $\pm$ 10%, 50V X7R ceramic capacitor (0603) Murata GRM188R71H104K TDK C1608X7R1H104K
C21	1	4.7 $\mu$ F $\pm$ 10%, 25V X7R ceramic capacitor (0805) Murata GRM21BR61E475K TDK C2012X5R1E475K
C23	1	2200pF $\pm$ 10%, 50V X7R ceramic capacitor (0402) Murata GRM155R71H222K TDK C1005X7R1H222K
C27	0	Not installed, ceramic capacitor (1206)
C29	1	4.7 $\mu$ F $\pm$ 10%, 50V X7R ceramic capacitor (1206) Murata GRM31CR71H475K
D1, D2	2	30V, 1A single Schottky diodes (SOD123) ON Semi MBR130T1
D3, D5	2	Dual, small-signal diodes (SOT23) Fairchild MMBD4148SE
D4	0	Not installed, diode (SOT23)

DESIGNATION	QTY	DESCRIPTION
J1	1	20-pin (2 x 10) right-angle receptacle
JU1, JU2	2	3-pin headers
JU3	0	Not installed, 3-pin header
JU4, JU5	0	Not installed, 2-pin headers
L1, L2	2	4.7 $\mu$ H, 1.5A, 45m $\Omega$ inductors (D53LC) TOKO A915AY-4R7M
N1	0	Not installed, n-channel MOSFET (SOT 23)
P1	0	Not installed, p-channel MOSFET (SOT 23)
Q1	1	40V npn transistor (TO92) Fairchild 2N3904
R1	1	357k $\Omega$ $\pm$ 1% resistor (0603)
R2	1	32.4k $\Omega$ $\pm$ 1% resistor (0603)
R3, R4, R9, R10, R14, R16, R19	7	0 $\Omega$ resistors (0603)
R5, R6	2	10k $\Omega$ $\pm$ 5% resistors (0603)
R7	1	806k $\Omega$ $\pm$ 1% resistor (0603)
R8	1	49.9k $\Omega$ $\pm$ 1% resistor (0603)
R11	1	332k $\Omega$ $\pm$ 1% resistor (0603)
R12	1	20k $\Omega$ $\pm$ 1% resistor (0603)
R13	1	10 $\Omega$ resistor (0603)
R15	1	0.5 $\Omega$ $\pm$ 1% resistor (0603)
R21	1	100k $\Omega$ $\pm$ 5% resistor (0603)
R22–R27	0	Not installed, resistors (0603)
REF	1	Test point
U1	1	DC-DC converter with VCOM (32 TQFN-EP*) Maxim MAX17135ETJ+
—	2	Shunts
—	1	PCB: MAX17135 EVALUATION KIT

\*EP = Exposed pad.

### Component Suppliers

SUPPLIER	PHONE	WEBSITE
Fairchild Semiconductor	888-522-5372	www.fairchildsemi.com
Murata Electronics North America, Inc.	770-436-1300	www.murata-northamerica.com
TDK Corp.	847-803-6100	www.component.tdk.com
TOKO America, Inc.	847-297-0070	www.tokoam.com

**Note:** Indicate that you are using the MAX17135 when contacting these component suppliers.

# MAX17135 Evaluation System

## Evaluates: MAX17135

### MAX17135 EV Kit Files

FILE	DESCRIPTION
INSTALL.EXE	Installs the EV kit files on your computer
MAX17135.EXE	Application program
ATUSBHID.DLL	USB software library
UNINST.INI	Uninstalls the EV kit software

### Quick Start

#### Recommended Equipment

- MAX17135 EV kit
- 2.7V to 5.5V DC power supply
- User-supplied Windows XP, Windows Vista, or Windows 7 PC with a spare USB port
- Voltmeter

**Note:** In the following sections, software-related items are identified by bolding. Text in **bold** refers to items directly from the EV kit software. Text in **bold and underlined** refers to items from the Windows operating system.

#### Procedure

The EV kit is fully assembled and tested. Follow the steps below to verify board operation. **Caution: Do not turn on the power supply until all connections are completed.**

- 1) On the CMAXQUSB+ command module, ensure that the shunt on jumper JU1 is in the 5V (default) position.
- 2) Carefully connect the boards by aligning the 20-pin connector (J1) on the EV kit with the 20-pin header on the CMAXQUSB+ interface board. Gently press them together.

- 3) Connect the USB cable from the computer's type-A USB port to the CMAXQUSB+ board's type-B USB port.
- 4) Verify that shunts are installed across pins 1-2 of jumpers JU1 and JU2.
- 5) Connect the positive terminal of the power supply to the IN PCB pad. Connect the negative terminal of the power supply to the PGND PCB pad closest to IN.
- 6) Turn on the power supply.
- 7) Verify that the step-up switching regulator output (POS) is 15V.
- 8) Verify that the step-up switching regulator output (NEG) is -15V.
- 9) Verify that the positive charge-pump supply (GVDD) is approximately 22V.
- 10) Verify that the negative charge-pump supply (GVEE) is approximately -20V.
- 11) Visit [www.maxim-ic.com/evkitsoftware](http://www.maxim-ic.com/evkitsoftware) to download the latest version of the EV kit software, MAX17135Rxx.ZIP. Save the EV kit software to a temporary folder and uncompress the ZIP file.
- 12) Install the EV kit software on your computer by running the INSTALL.EXE program inside the temporary folder. The program files are copied and icons are created in the Windows Start | Programs menu.
- 13) Start the EV kit software by opening its icon in the Start | Programs menu.
- 14) Normal device operation is verified when MAX17135 device connected is displayed in the bottom-left status bar on the EV kit main window (Figure 1).

# MAX17135 Evaluation System

## Evaluates: MAX17135

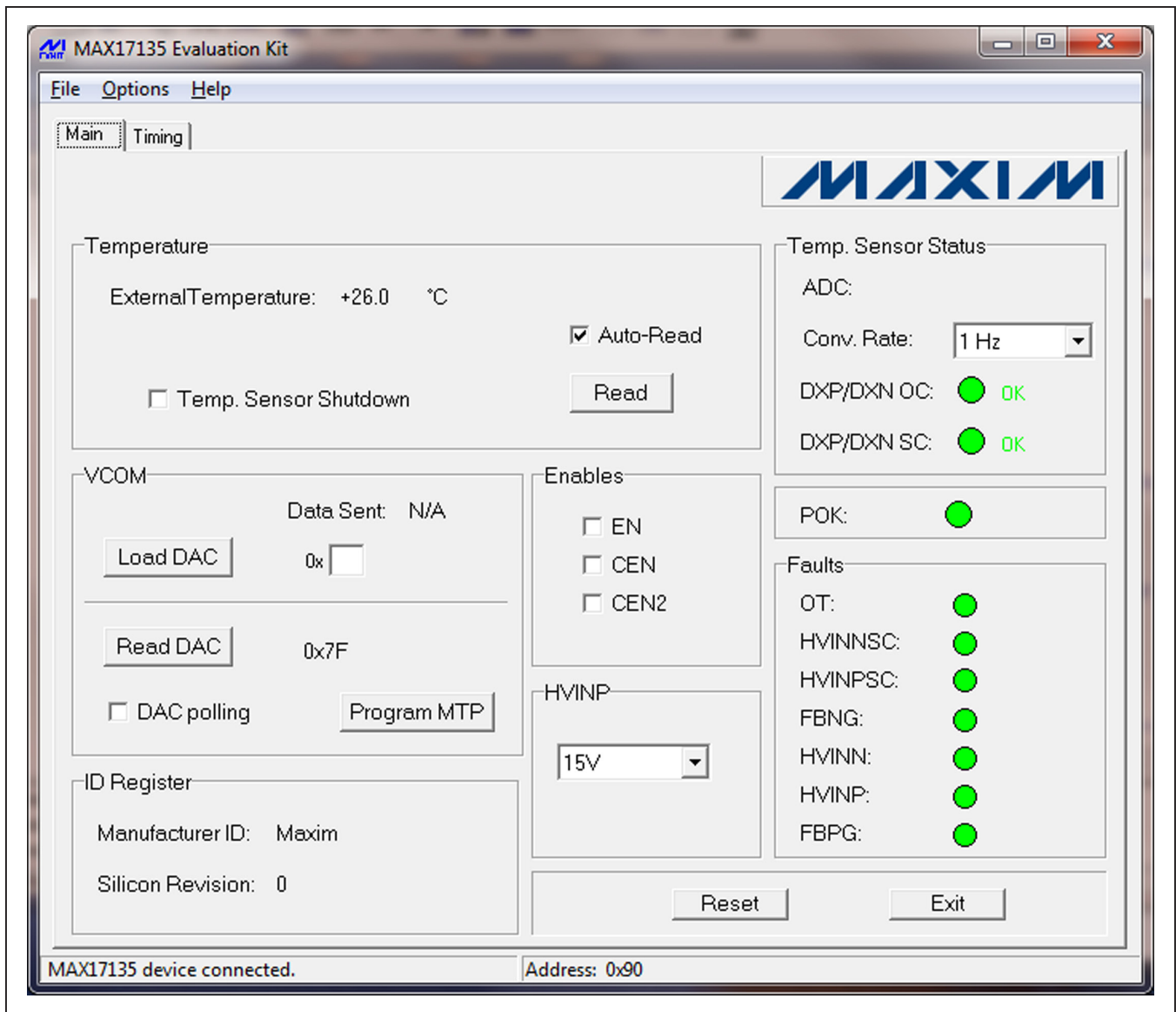

Figure 1. MAX17135 EV Kit Software (Main Tab)

# MAX17135 Evaluation System

## Evaluates: MAX17135

### Detailed Description of Hardware

The MAX17135 EV system (MAX17135EVCMAXQU#) consists of the MAX17135 EV kit (MAX17135EVKIT#) and the Maxim CMAXQUSB+ command module. The EV kit evaluates the MAX17135 power-management solution for E-paper displays and the CMAXQUSB+ provides the I<sup>2</sup>C/SMBus-compatible interface for software control of the IC's programmable features.

The EV kit operates from a 2.7V to 5.5V DC supply voltage. The step-up switching regulator (POS) is configured for a 15V output that provides 200mA. The inverting buck-boost converter (NEG) generates a -15V output that provides 200mA. The gate-driver power supplies consist of regulated charge pumps that generate 22V (GVDD) and -20V (GVEE) and can deliver up to 20mA each. The EV kit also features a digitally adjustable VCOM amplifier and the option for external temperature sensing.

The CMAXQUSB+ command module provides the I<sup>2</sup>C/SMBus interface and is connected to the computer through the USB port. The EV kit also includes Windows XP-, Windows Vista-, and Windows 7-compatible software that provide a simple GUI for exercising the features of the IC.

#### Enable Input (EN)

The IC's source-driver and gate-driver outputs (POS, NEG, GVDD, and GVEE) are controlled by driving the EN pin. When EN is connected to VDD, the outputs are enabled. When EN is connected to GND, the outputs are disabled. See Table 1 for jumper JU1 configuration.

#### VCOM Amplifier Output Enable Input (CEN)

The IC's VCOM amplifier output can be controlled by driving the CEN pin. When CEN is connected to VDD, VCOM is enabled. When CEN is connected to GND, VCOM is disabled. See Table 2 for jumper JU2 configuration.

#### Source-Driver Output-Voltage Selection

The EV kit's step-up switching-regulator output (POS) is set to 15V by feedback resistors R1 and R2. To generate output voltages other than 15V (17V max), select different external voltage-divider resistors, R1 and R2. The negative source-driver supply voltage (NEG) is automatically tightly regulated to -POS within  $\pm 50\text{mV}$ . NEG cannot be adjusted independently of POS. Refer to the *Source-Driver Power Supplies* section in the MAX17135 IC data sheet for more information.

#### Gate-Driver Output-Voltage Selection

The EV kit's positive gate-driver power supply (GVDD) is set to 22V by feedback resistors R11 and R12. To generate output voltages other than 22V, select different external voltage-divider resistors, R11 and R12. The negative gate-driver power supply (GVEE) is set to -20V by feedback resistors R7 and R8. To generate output voltages other than -20V, select different external voltage-divider resistors, R7 and R8. Refer to the *Gate-Driver Power Supplies* section in the MAX17135 IC data sheet for more information.

**Table 1. Jumper Functions (JU1)**

SHUNT POSITION	EN PIN	SOURCE- AND GATE-DRIVER OUTPUTS
1-2*	Connected to VDD	Enabled
2-3	Connected to GND	Disabled

\*Default position.

**Table 2. Jumper Functions (JU2)**

SHUNT POSITION	CEN PIN	VCOM OUTPUT
1-2*	Connected to VDD	Enabled
2-3	Connected to GND	Disabled

\*Default position.

# MAX17135 Evaluation System

## Evaluates: MAX17135

### Detailed Description of Software

The MAX17135 EV kit software consists of two tabs: **Main** and **Timing**. The **Main** tab sheet (Figure 1) features controls for reading temperature, VCOM adjustment, enables, HVINP control, temperature sensor status, POK, and monitoring faults. The **Timing** tab sheet (Figure 2) features controls for power-up/power-down sequence and timing between the GVDD, NEG, POS, and GVDD power rails. Refer to the MAX17135 IC data sheet for further details.

### MAX17135 EV Kit Software (Main Tab) Temperature

The EV kit software can read external temperature at a remote diode; this value is displayed on the main software interface in degrees Celsius. If the **Auto-Read** checkbox in the **Temperature** group box is checked, the external temperature register is continuously read. If this checkbox is not checked, the user needs to manually press the **Read** button to monitor the temperature. To place the temperature sensor in shutdown mode, check the **Temp. Sensor Shutdown** checkbox.

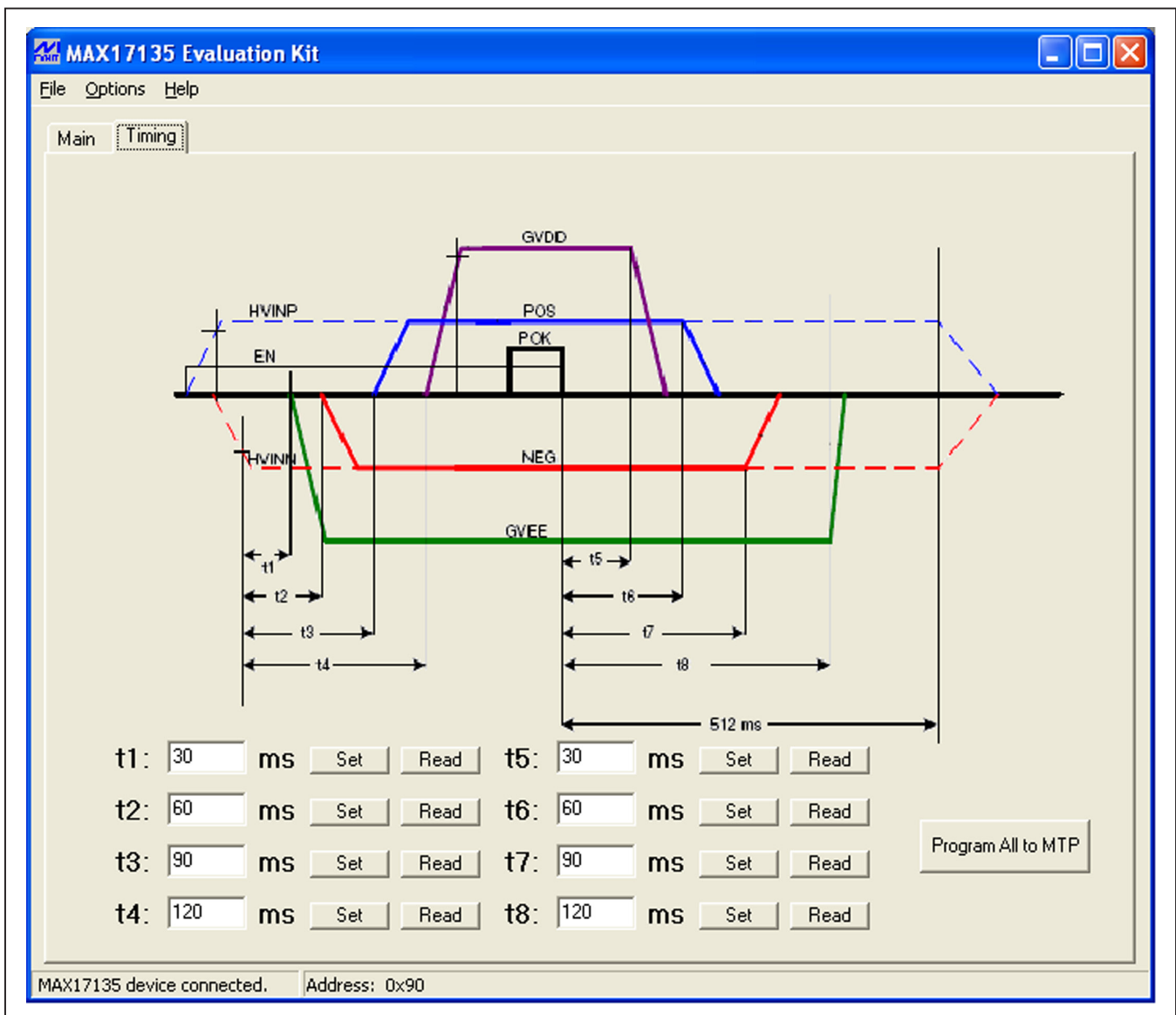

Figure 2. MAX17135 EV Kit Software (Timing Tab)



# MAX17135 Evaluation System

## Evaluates: MAX17135

### Temperature-Sensor Status

The temperature-sensor Status register indicates whether the ADC is in the process of performing a temperature conversion. The conversion rate can be set by selecting the desired value from the **Conv. Rate** drop-down list in the **Temp. Sensor Status** group box. **DXP/DXN OC** monitors open-circuit connections from DXN and DXP to the remote temperature-sensing diode on board. **DXP/DXN SC** indicates when there is a short-circuit condition between DXP and DXN.

### VCOM

The DAC setting corresponds to the specific VCOM voltage. With the EV kit software, the IC's 8-bit internal DAC is configured by entering an appropriate DAC setting into the **Load DAC** edit box in the **VCOM** group box. The DAC setting can be set from 0x00 (VCOMMAX) to 0xFF (VCOMMIN). The DAC setting is written to the IC by pressing the **Load DAC** button (Figure 1).

The IC's 8-bit DAC is read by either pressing the **Read DAC** button or by checking the **DAC polling** checkbox. When checked, the software continuously reads and displays the DAC's current setting.

The current DAC setting can be programmed into the IC's internal nonvolatile memory by pressing the **Program MTP** button. Each time the IC is powered on, the DAC is loaded with the setting stored in the IC's nonvolatile memory. The nonvolatile memory containing the power-up DVR setting can be changed up to 30 times. The I<sup>2</sup>C bus returns NACK, if the DVR nonvolatile memory is attempted to be programmed more than 30 times.

### Enables

The output enable functions performed by the EN and CEN pins can also be performed through I<sup>2</sup>C commands by setting the function's corresponding enable bit in the Enable register. By checking the **EN**, **CEN**, or **CEN2** checkbox in the **Enables** group box, the corresponding outputs are enabled. Each function's enable bit is ORed with the status of its corresponding enable pin. Refer to the MAX17135 IC data sheet for further details.

### HVINP

The POS regulation voltage is determined by the boost converter's output regulation voltage (VHVINP). The HVINP regulation voltage is set by using a resistor-divider network, or by programming the corresponding value of the desired HVINP regulation voltage into the HVINP register through I<sup>2</sup>C. To set the HVINP regulation voltage through I<sup>2</sup>C, first connect the FBP pin to GND. With FBP connected to GND, the HVINP register is

automatically loaded with 0Ah to set to the HVINP regulation voltage to 15V after IN and VDD have exceeded their undervoltage-lockout thresholds. If another HVINP regulation voltage other than 15V is needed, select the desired value from the drop-down list in the **HVINP** group box.

### POK and Faults

The EV kit software monitors POK status and various fault conditions. POK is a status indicator that is asserted after FBNG, NEG, POS, and FBPG have all exceeded 80% of their regulation voltages and all soft-start periods have completed.

When a fault condition is detected, the corresponding bit's green fault indicator turns red. After the fault condition is removed, the fault register is cleared by pulling the EN pin low then high again, by setting the EN bit high, or by powering off then powering on V<sub>IN</sub>. Refer to the *Fault Register (0Ah) R/W* section in the MAX17135 IC data sheet for more detailed information regarding fault conditions.

### MAX17135 EV Kit Software (Timing Tab)

In the **Timing** tab sheet (Figure 2), the power-up/power-down sequence and timing between the GVEE, NEG, POS, and GVDD power rails can be set by programming the t1–t8 Timing registers with corresponding values. During power-up of the IC, once IN and VDD exceed their undervoltage-lockout thresholds, the t1–t8 Timing registers are loaded with values stored in the nonvolatile memory to preset the t1–t8 timing. The factory-default timing settings in the nonvolatile memory are:

- t1 = t5 = 30ms
- t2 = t6 = 60ms
- t3 = t7 = 90ms
- t4 = t8 = 120ms

To change the preset t1–t8 timing, set all desired values and press the **Program All to MTP** button.

### Simple SMBus Commands

There are two methods for communicating with the IC: through the EV kit software main windows (Figures 1 and 2), or through the **Advanced Users Interface** window, which is available by selecting the **Options | Interface (Advanced Users)** menu item from the menu bar. The Maxim command module interface window (Figure 3) includes a **2-wire interface** tab that allows for execution of the **SMBusSendByte()**, **SMBusReceiveByte()**, and **SMBusQuick()** commands.

# MAX17135 Evaluation System

## Evaluates: MAX17135

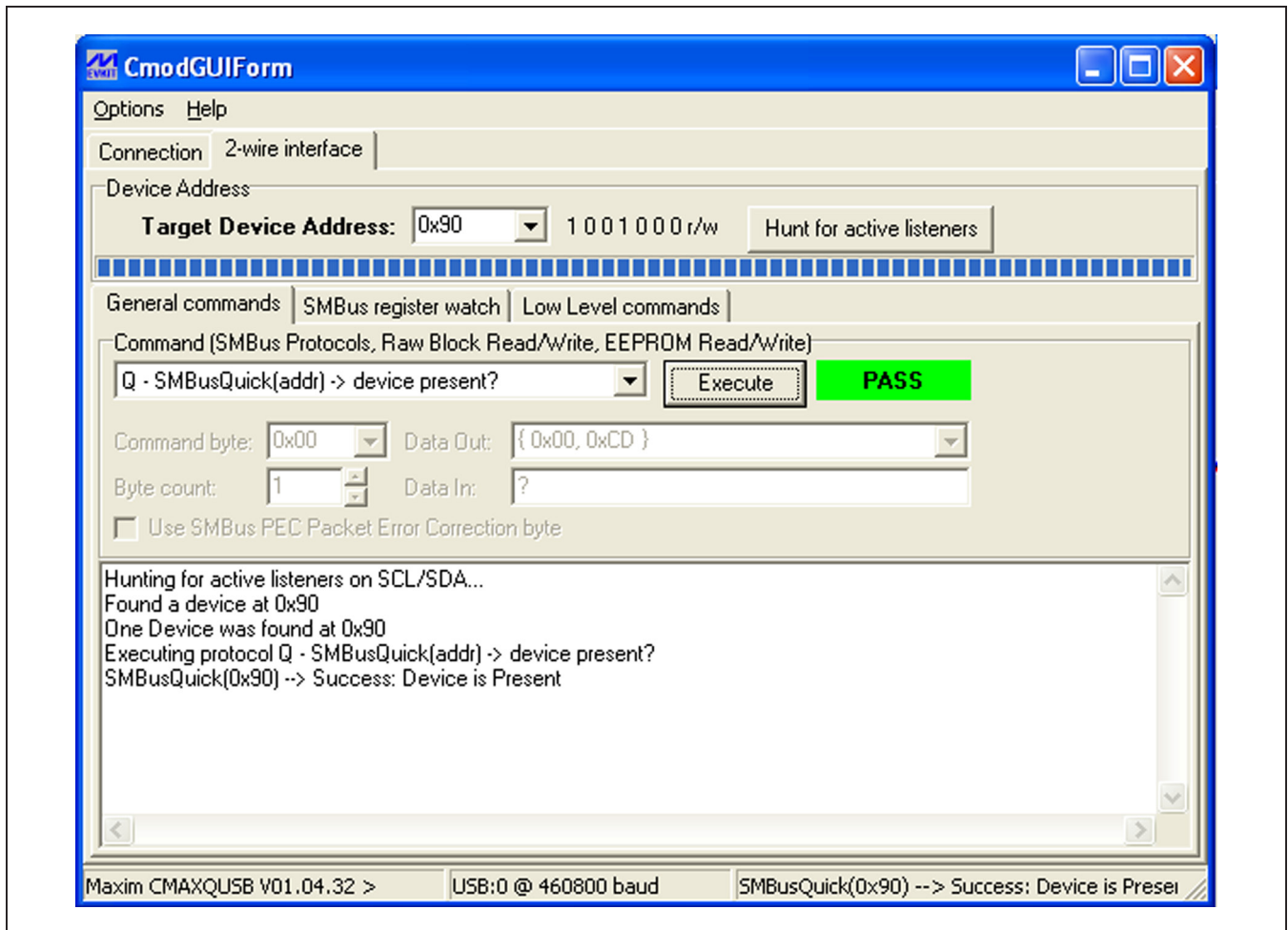

Figure 3. Command Module Interface Window



# MAX17135 Evaluation System

## Evaluates: MAX17135

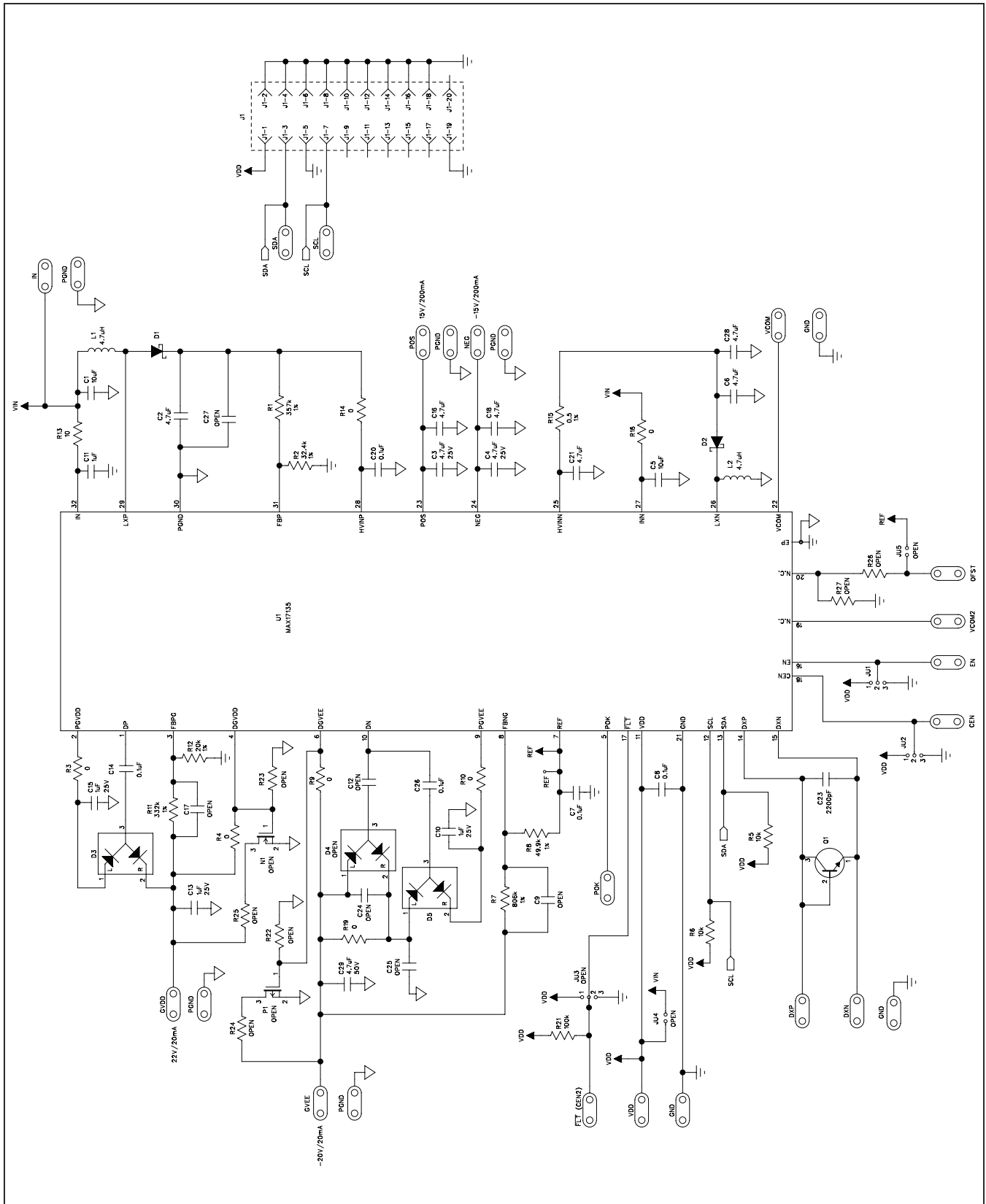

Figure 4. MAX17135 EV Kit Schematic

# MAX17135 Evaluation System

## Evaluates: MAX17135

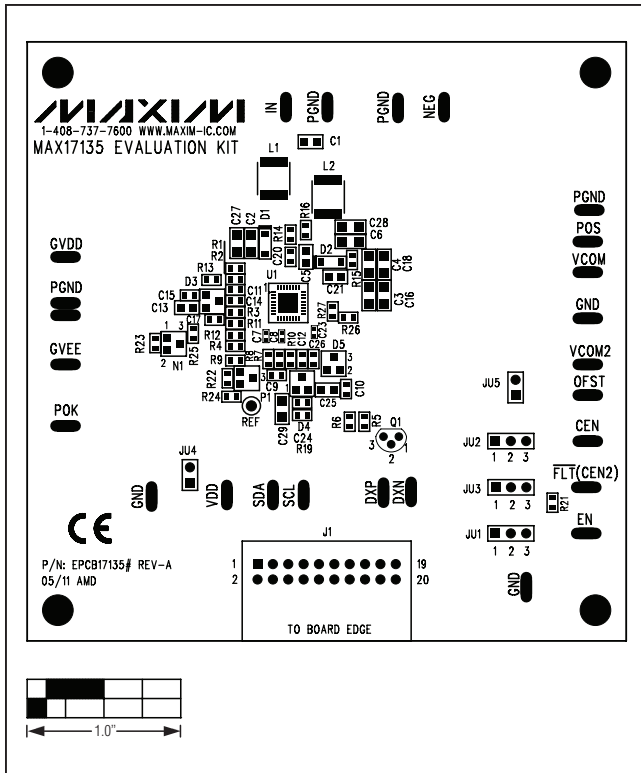

Figure 5. MAX17135 EV Kit Component Placement Guide—Component Side

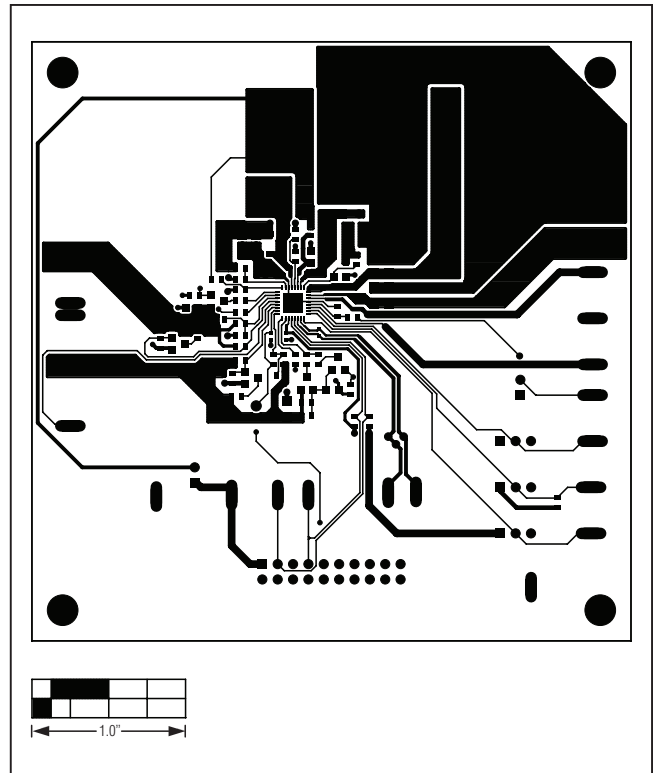

Figure 6. MAX17135 EV Kit PCB Layout—Component Side

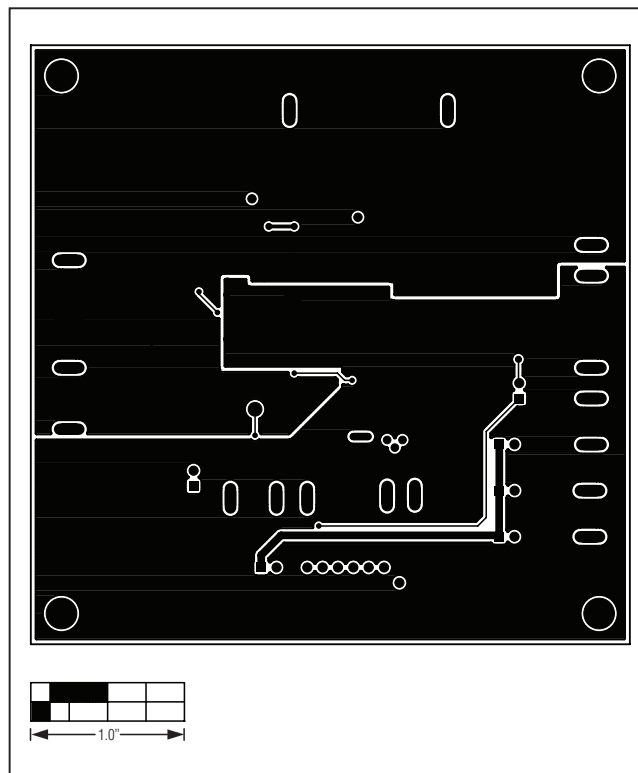

Figure 7. MAX17135 EV Kit PCB Layout—Solder Side

# MAX17135 Evaluation System

## Evaluates: MAX17135

### Ordering Information

PART	TYPE
MAX17135EVKIT#	EV Kit
MAX17135EVCMAXQU#	EV System

#Denotes RoHS compliant.

**Note:** The CMAXQUSB+ command module is required when using the EV kit software.

# MAX17135 Evaluation System

## Evaluates: MAX17135

### Revision History

REVISION NUMBER	REVISION DATE	DESCRIPTION	PAGES CHANGED
0	6/11	Initial release	—
1	1/12	Updated <i>Component List</i> , replaced Figure 4	2, 9

Maxim cannot assume responsibility for use of any circuitry other than circuitry entirely embodied in a Maxim product. No circuit patent licenses are implied. Maxim reserves the right to change the circuitry and specifications without notice at any time.

**Maxim Integrated Products, 120 San Gabriel Drive, Sunnyvale, CA 94086 408-737-7600** \_\_\_\_\_ **12**