



Low-Noise, Low-Dropout, 150mA Linear Regulators in SOT23

MAX8867/MAX8868

General Description

The MAX8867/MAX8868 low-noise, low-dropout linear regulators operate from a 2.5V to 6.5V input and deliver up to 150mA. Typical output noise for these devices is just 30µVRMS, and typical dropout is only 165mV at 150mA. The output voltage is preset to voltages in the range of 2.5V to 5.0V, in 100mV increments. The MAX8867 and MAX8868 are pin-compatible with the MAX8863 and MAX8864, except for the BP pin.

Designed with an internal P-channel MOSFET pass transistor, the MAX8867/MAX8868 maintain a low 100µA supply current, independent of the load current and dropout voltage. Other features include a 10nA logic-controlled shutdown mode, short-circuit and thermal-shutdown protection, and reverse battery protection. The MAX8868 also includes an auto-discharge function, which actively discharges the output voltage to ground when the device is placed in shutdown. Both devices come in regular and thin 5-pin SOT23 packages.

Features

- ◆ Low Output Noise: 30µVRMS
- ◆ Low 55mV Dropout at 50mA Output (165mV at 150mA output)
- ◆ Low 85µA No-Load Supply Current
- ◆ Low 100µA Operating Supply Current (Even In Dropout)
- ◆ Thermal-Overload and Short-Circuit Protection
- ◆ Reverse Battery Protection
- ◆ Output Current Limit
- ◆ Preset Output Voltages (±1.4% Accuracy)
- ◆ 10nA Logic-Controlled Shutdown

Applications

| | |
|---------------------|-----------------------|
| Cellular Telephones | Modems |
| Cordless Telephones | Hand-Held Instruments |
| PCS Telephones | Palmtop Computers |
| PCMCIA Cards | Electronic Planners |

Ordering Information

| PART** | TEMP RANGE | PIN-PACKAGE |
|----------------|----------------|-----------------|
| MAX8867EUKxy-T | -40°C to +85°C | SOT23-5 Regular |
| MAX8867EZKxy-T | -40°C to +85°C | SOT23-5 Thin |
| MAX8867C/Dxy | 0°C to +70°C | Dice* |
| MAX8868EUKxy-T | -40°C to +85°C | SOT23-5 Regular |
| MAX8868EZKxy-T | -40°C to +85°C | SOT23-5 Thin |
| MAX8868C/Dxy | 0°C to +70°C | Dice* |

*Dice are tested at $T_A = +25^\circ\text{C}$ only.

**xy is the output voltage code (see Expanded Ordering Information table at end of data sheet).

Typical Operating Circuit

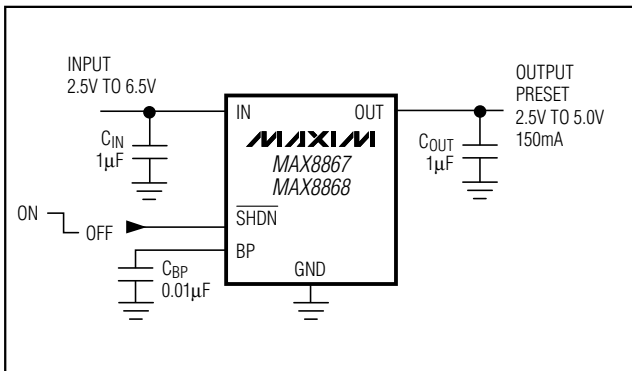

Pin Configuration

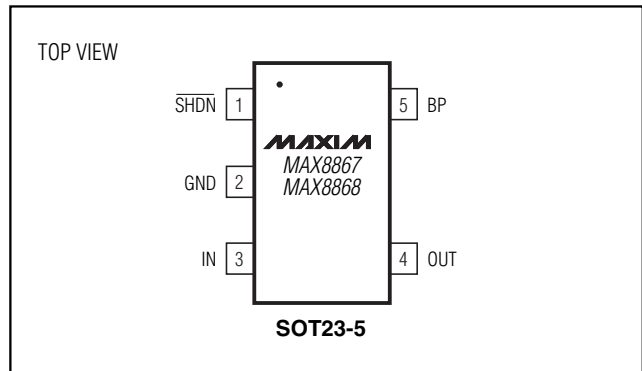

Low-Noise, Low-Dropout, 150mA Linear Regulators in SOT23

ABSOLUTE MAXIMUM RATINGS

| | |
|---|--|
| IN to GND | -7V to +7V |
| Output Short-Circuit Duration | Infinite |
| $\overline{\text{SHDN}}$ to GND | -7V to +7V |
| $\overline{\text{SHDN}}$ to IN | -7V to +0.3V |
| OUT, BP to GND | -0.3V to ($V_{\text{IN}} + 0.3\text{V}$) |
| Continuous Power Dissipation ($T_A = +70^\circ\text{C}$) | |
| SOT23-5 Regular (derate 7.1mW/ $^\circ\text{C}$ above $+70^\circ\text{C}$) | ...571mW |

| | |
|--|---|
| SOT23-5 Thin (derate 9.1mW/ $^\circ\text{C}$ above $+70^\circ\text{C}$) |727mW |
| Operating Temperature Range | -40°C to $+85^\circ\text{C}$ |
| Junction Temperature | $+150^\circ\text{C}$ |
| θ_{JB} (Regular) | $140^\circ\text{C}/\text{W}$ |
| θ_{JB} (Thin) | $110^\circ\text{C}/\text{W}$ |
| Storage Temperature | -65°C to $+150^\circ\text{C}$ |
| Lead Temperature (soldering, 10s) | $+300^\circ\text{C}$ |

Stresses beyond those listed under "Absolute Maximum Ratings" may cause permanent damage to the device. These are stress ratings only, and functional operation of the device at these or any other conditions beyond those indicated in the operational sections of the specifications is not implied. Exposure to absolute maximum rating conditions for extended periods may affect device reliability.

ELECTRICAL CHARACTERISTICS

($V_{\text{IN}} = V_{\text{OUT(NOMINAL)}} + 0.5\text{V}$, $T_A = -40^\circ\text{C}$ to $+85^\circ\text{C}$, unless otherwise noted. Typical values are at $T_A = +25^\circ\text{C}$.) (Note 1)

| PARAMETER | SYMBOL | CONDITIONS | MIN | TYP | MAX | UNITS |
|---|-------------------------|---|--|------|------|------------------|
| Input Voltage (Note 2) | V_{IN} | | 2.5 | | 6.5 | V |
| Output Voltage Accuracy | | $I_{\text{OUT}} = 0\text{mA}$, $T_A = +25^\circ\text{C}$ | -1.4 | | 1.4 | % |
| | | $I_{\text{OUT}} = 0\text{mA}$ to 120mA | -3 | | 2 | |
| Maximum Output Current | | | 150 | | | mA |
| Current Limit | I_{LIM} | | 160 | 390 | | mA |
| Ground-Pin Current | I_{Q} | No load | | 85 | 180 | μA |
| | | $I_{\text{OUT}} = 150\text{mA}$ | | 100 | | |
| Dropout Voltage (Note 2) | | $I_{\text{OUT}} = 1\text{mA}$ | | 1.1 | | mV |
| | | $I_{\text{OUT}} = 50\text{mA}$ | | 55 | 120 | |
| | | $I_{\text{OUT}} = 150\text{mA}$ | | 165 | | |
| Line Regulation | ΔV_{LNR} | $V_{\text{IN}} = (V_{\text{OUT}} + 0.1\text{V})$ to 6.5V , $I_{\text{OUT}} = 1\text{mA}$ | -0.15 | 0 | 0.15 | %/V |
| Load Regulation | ΔV_{LDR} | $I_{\text{OUT}} = 0\text{mA}$ to 120mA , $C_{\text{OUT}} = 1\mu\text{F}$ | | 0.01 | 0.04 | %/mA |
| Output Voltage Noise | e_{n} | $f = 10\text{Hz}$ to 100kHz , $C_{\text{BP}} = 0.01\mu\text{F}$ | $C_{\text{OUT}} = 10\mu\text{F}$ | | 30 | μVRMS |
| | | | $C_{\text{OUT}} = 100\mu\text{F}$ | | 20 | |
| SHUTDOWN | | | | | | |
| $\overline{\text{SHDN}}$ Input Threshold | V_{IH} | $V_{\text{IN}} = 2.5\text{V}$ to 5.5V | 2.0 | | | V |
| | V_{IL} | $V_{\text{IN}} = 2.5\text{V}$ to 5.5V | | | 0.4 | |
| $\overline{\text{SHDN}}$ Input Bias Current | I_{SHDN} | $V_{\text{SHDN}} = V_{\text{IN}}$ | $T_A = +25^\circ\text{C}$ | 0.01 | 100 | nA |
| | | | $T_A = +85^\circ\text{C}$ | 0.5 | | |
| Shutdown Supply Current | $I_{\text{Q, SHDN}}$ | $V_{\text{OUT}} = 0\text{V}$ | $T_A = +25^\circ\text{C}$ | 0.01 | 1 | μA |
| | | | $T_A = +85^\circ\text{C}$ | 0.2 | | |
| Shutdown Exit Delay (Note 3) | | $C_{\text{BP}} = 0.1\mu\text{F}$, $C_{\text{OUT}} = 1\mu\text{F}$, no load | $T_A = +25^\circ\text{C}$ | 30 | 150 | μs |
| | | | $T_A = -40^\circ\text{C}$ to $+85^\circ\text{C}$ | | 300 | |
| Shutdown Discharge Resistance | | MAX8868 only | | 300 | | Ω |

Low-Noise, Low-Dropout, 150mA Linear Regulators in SOT23

MAX8867/MAX8868

ELECTRICAL CHARACTERISTICS (continued)

($V_{IN} = V_{OUT(NOMINAL)} + 0.5V$, $T_A = -40^{\circ}C$ to $+85^{\circ}C$, unless otherwise noted. Typical values are at $T_A = +25^{\circ}C$.) (Note 1)

| PARAMETER | SYMBOL | CONDITIONS | MIN | TYP | MAX | UNITS |
|------------------------------|--------------------|------------|-----|-----|-----|-------|
| THERMAL PROTECTION | | | | | | |
| Thermal-Shutdown Temperature | T _{SHDN} | | | 155 | | °C |
| Thermal-Shutdown Hysteresis | ΔT _{SHDN} | | | 15 | | °C |

Note 1: Limits are 100% production tested at $T_A = +25^{\circ}C$. Limits over the operating temperature range are guaranteed through correlation using Statistical Quality Control (SQC) Methods.

Note 2: The dropout voltage is defined as $V_{IN} - V_{OUT}$, when V_{OUT} is 100mV below the value of V_{OUT} for $V_{IN} = V_{OUT} + 0.5V$.

Note 3: Time needed for V_{OUT} to reach 95% of final value.

Typical Operating Characteristics

($V_{IN} = V_{OUT(NOMINAL)} + 0.5V$, $C_{IN} = 1\mu F$, $C_{OUT} = 1\mu F$, $C_{BP} = 0.01\mu F$, $T_A = +25^{\circ}C$, unless otherwise noted.)

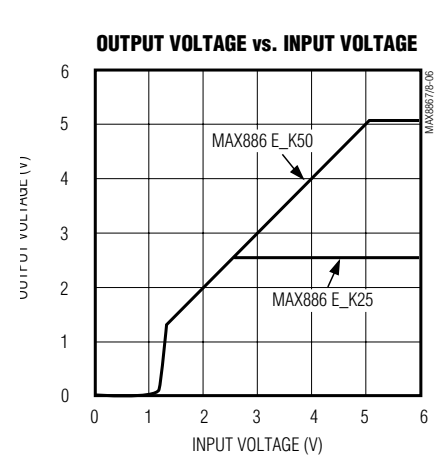
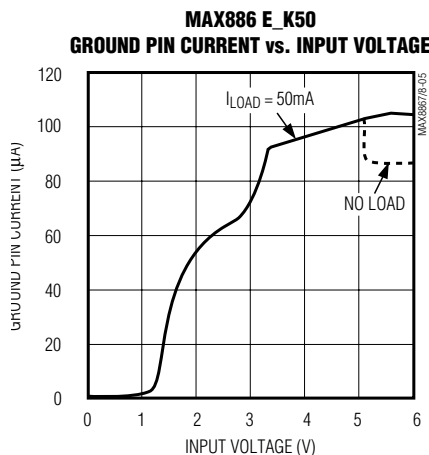
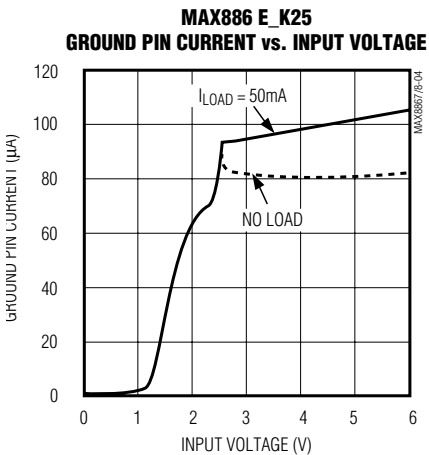
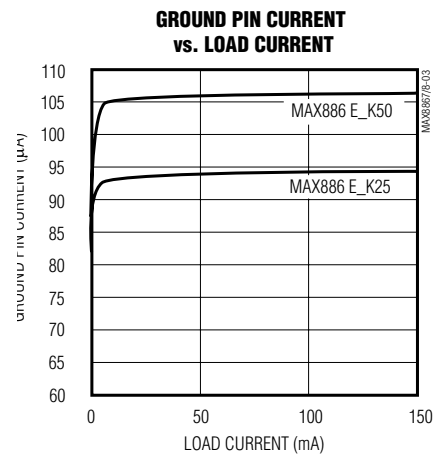
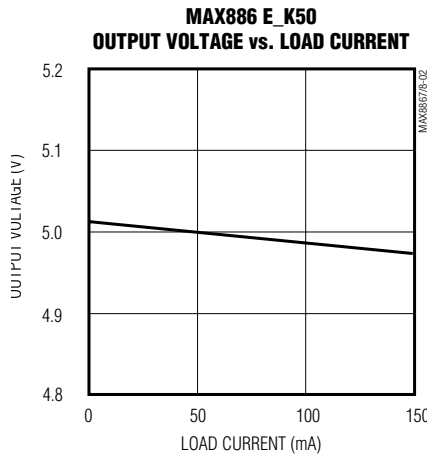
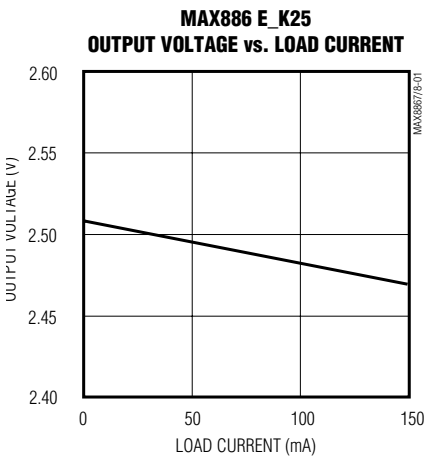

Low-Noise, Low-Dropout, 150mA Linear Regulators in SOT23

Typical Operating Characteristics (continued)

($V_{IN} = V_{OUT(NOMINAL)} + 0.5V$, $C_{IN} = 1\mu F$, $C_{OUT} = 1\mu F$, $C_{BP} = 0.01\mu F$, $T_A = +25^\circ C$, unless otherwise noted.)

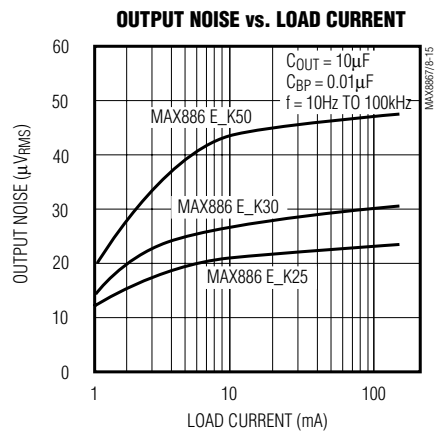
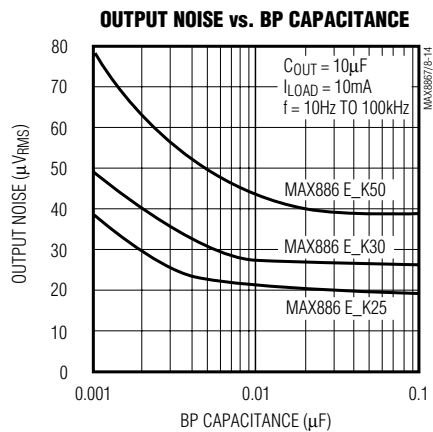
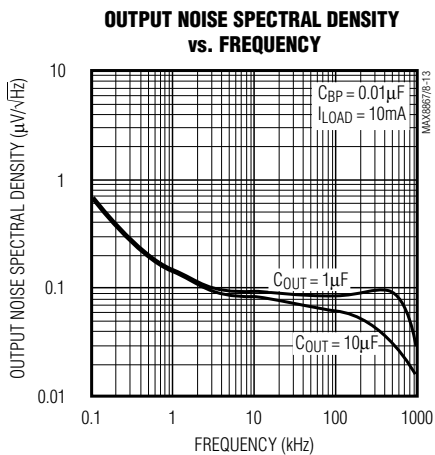
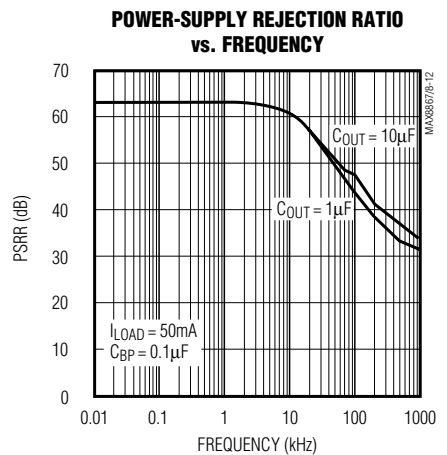
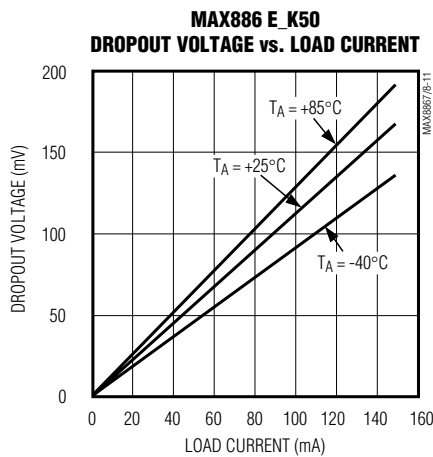
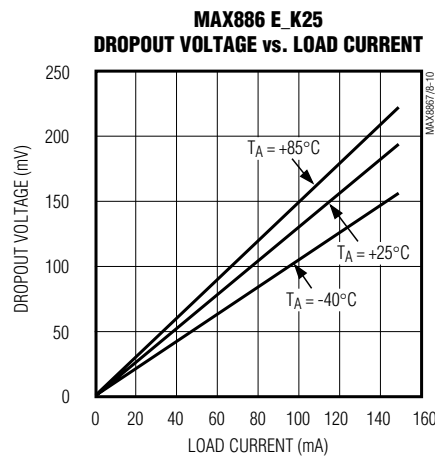
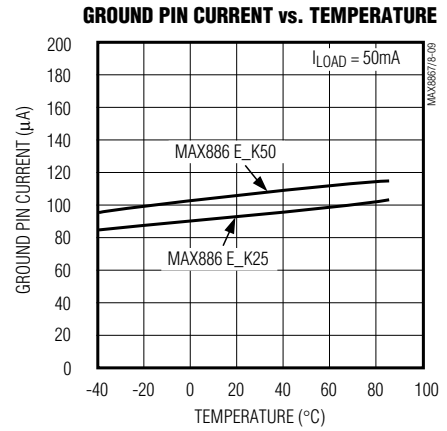
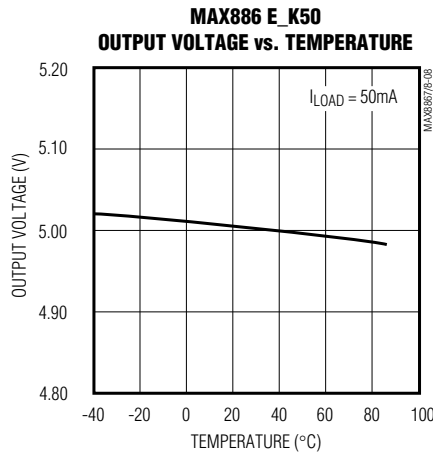
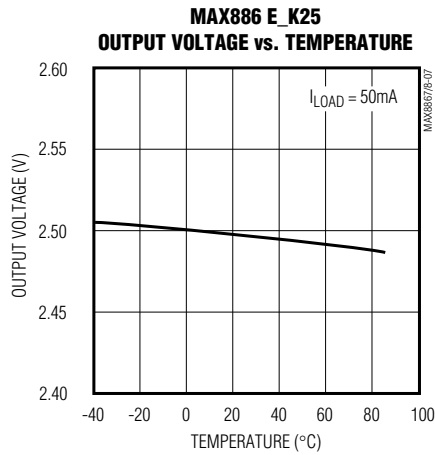

Low-Noise, Low-Dropout, 150mA Linear Regulators in SOT23

MAX8867/MAX8868

Typical Operating Characteristics (continued)

($V_{IN} = V_{OUT(NOMINAL)} + 0.5V$, $C_{IN} = 1\mu F$, $C_{OUT} = 1\mu F$, $C_{BP} = 0.01\mu F$, $T_A = +25^\circ C$, unless otherwise noted.)

LOAD-TRANSIENT RESPONSE

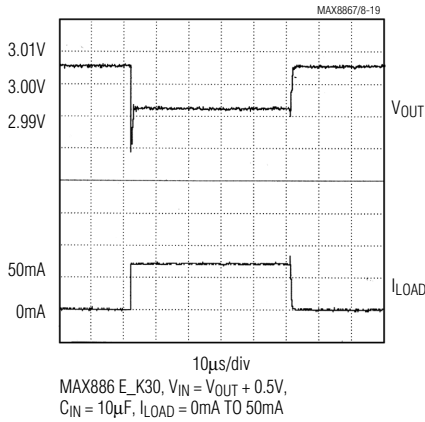

LOAD-TRANSIENT RESPONSE NEAR DROPOUT

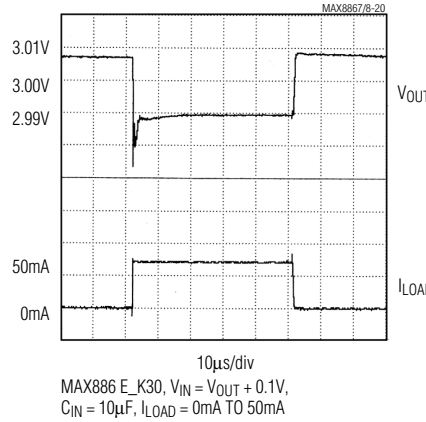

LINE-TRANSIENT RESPONSE

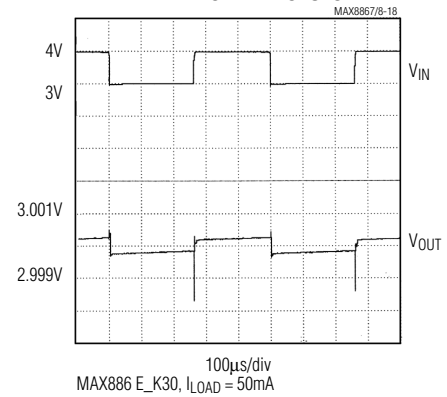

MAX8868 ENTERING SHUTDOWN

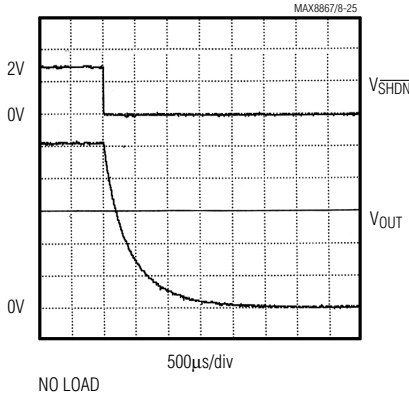

MAX886 E_K25 SHUTDOWN EXIT DELAY

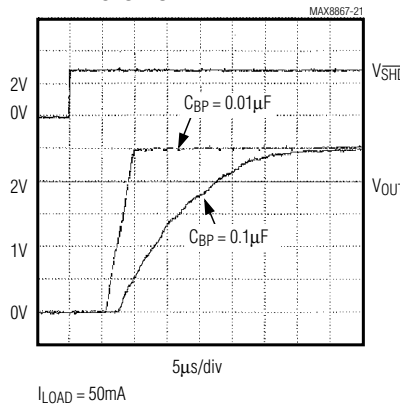

MAX886 E_K50 SHUTDOWN EXIT DELAY

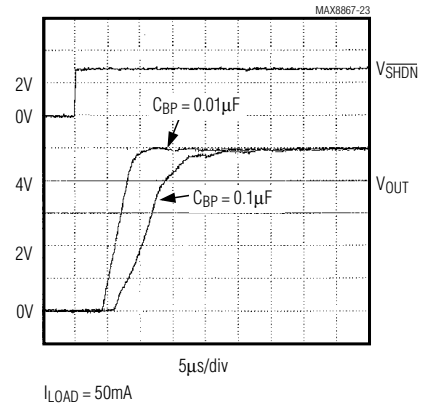

MAX886 E_K25 10Hz TO 100kHz OUTPUT NOISE

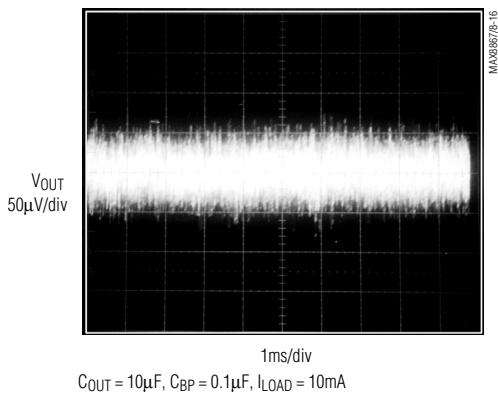

REGION OF STABLE C_{OUT} ESR vs. LOAD CURRENT

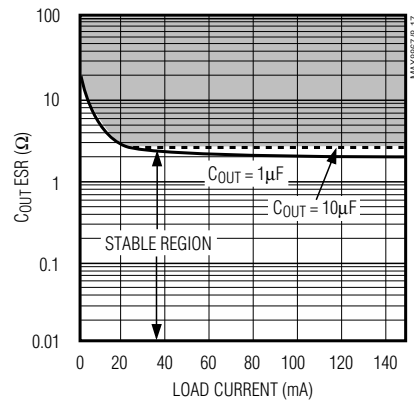

Low-Noise, Low-Dropout, 150mA Linear Regulators in SOT23

Pin Description

| PIN | NAME | FUNCTION |
|-----|--------------------------|--|
| 1 | $\overline{\text{SHDN}}$ | Active-Low Shutdown Input. A logic low reduces the supply current to 10nA. On the MAX8868, a logic low also causes the output voltage to discharge to GND. Connect to IN for normal operation. |
| 2 | GND | Ground. This pin also functions as a heatsink. Solder to a large pad or the circuit-board ground plane to maximize power dissipation. |
| 3 | IN | Regulator Input. Supply voltage can range from 2.5V to 6.5V. Bypass with a 1 μ F capacitor to GND (see <i>Capacitor Selection and Regulator Stability</i> section). |
| 4 | OUT | Regulator Output. Sources up to 150mA. Bypass with a 1 μ F (<0.2 Ω typical ESR) capacitor to GND. |
| 5 | BP | Reference-Noise Bypass. Bypass with a low-leakage, 0.01 μ F ceramic capacitor for reduced noise at the output. |

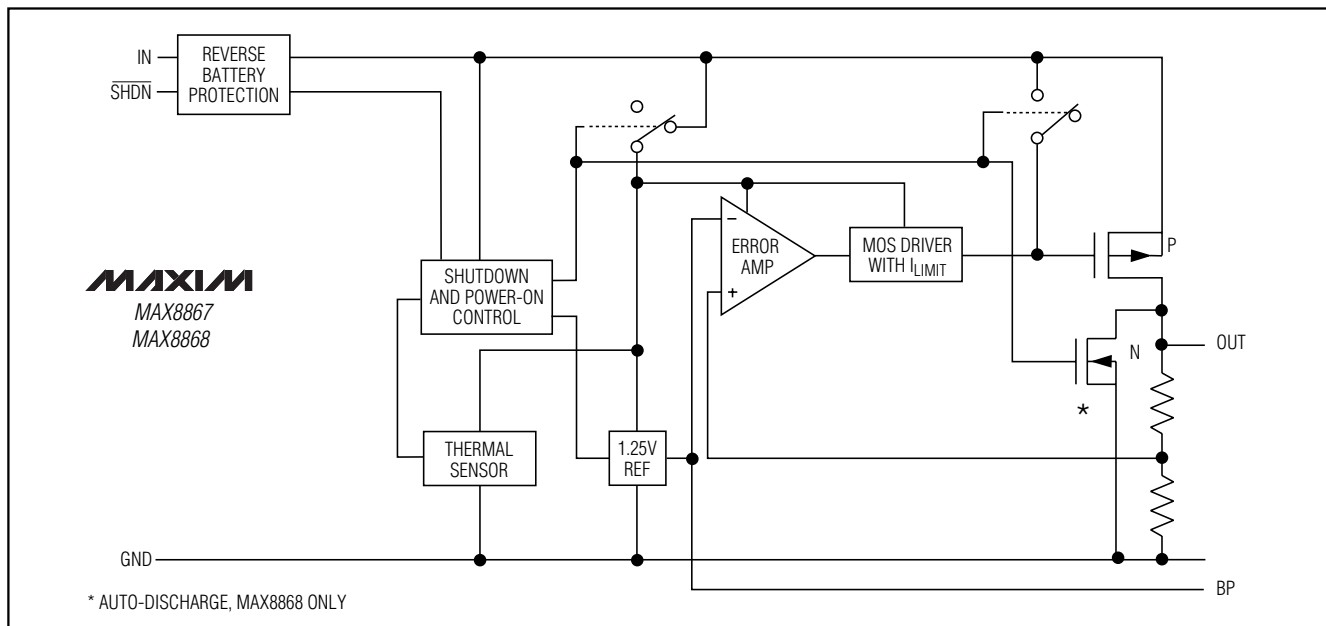

Figure 1. Functional Diagram

Detailed Description

The MAX8867/MAX8868 are low-noise, low-dropout, low-quiescent-current linear regulators designed primarily for battery-powered applications. The parts are available with preset output voltages varying from 2.5V to 5.0V in 100mV increments. These devices can supply loads up to 150mA. As illustrated in Figure 1, the MAX8867/MAX8868 consist of a 1.25V reference, error amplifier, P-channel pass transistor, and internal feedback voltage divider.

The 1.25V bandgap reference is connected to the error amplifier's inverting input. The error amplifier compares this reference with the feedback voltage and amplifies the difference. If the feedback voltage is lower than the reference voltage, the pass-transistor gate is pulled lower, which allows more current to pass to the output and increases the output voltage. If the feedback voltage is too high, the pass-transistor gate is pulled up, allowing less current to pass to the output. The output voltage is fed back through an internal resistor voltage divider connected to the OUT pin.

Low-Noise, Low-Dropout, 150mA Linear Regulators in SOT23

MAX8867/MAX8868

An external bypass capacitor connected to the BP pin reduces noise at the output. Additional blocks include a current limiter, reverse battery protection, thermal sensor, and shutdown logic. The MAX8868 also includes an auto-discharge function, which actively discharges the output voltage to ground when the device is placed in shutdown mode.

Output Voltage

The MAX8867/MAX8868 are supplied with factory-set output voltages from 2.5V to 5V, in 100mV increments. Except for the MAX886 E_K29 and the MAX886 E_K32 (which have an output voltage preset at 2.84V and 3.15V, respectively), the two-digit suffix allows the customer to choose the output voltage in 100mV increments. For example, the MAX8867EUK33 has a preset output voltage of 3.3V. (see *Expanded Ordering Information*).

Internal P-Channel Pass Transistor

The MAX8867/MAX8868 feature a 1.1 Ω typical P-channel MOSFET pass transistor. This provides several advantages over similar designs using PNP pass transistors, including longer battery life. The P-channel MOSFET requires no base drive, which reduces quiescent current considerably. PNP-based regulators waste considerable current in dropout when the pass transistor saturates. They also use high base-drive currents under large loads. The MAX8867/MAX8868 do not suffer from these problems and consume only 100 μ A of quiescent current whether in dropout, light-load, or heavy-load applications (see the *Typical Operating Characteristics*).

Current Limit

The MAX8867/MAX8868 include a current limiter, which monitors and controls the pass transistor's gate voltage, limiting the output current to 390mA. For design purposes, consider the current limit to be 160mA minimum to 500mA maximum. The output can be shorted to ground for an indefinite amount of time without damaging the part.

Thermal-Overload Protection

Thermal-overload protection limits total power dissipation in the MAX8867/MAX8868. When the junction temperature exceeds $T_J = +170^\circ\text{C}$, the thermal sensor signals the shutdown logic, turning off the pass transistor and allowing the IC to cool. The thermal sensor will turn the pass transistor on again after the IC's junction temperature cools by 20°C , resulting in a pulsed output during continuous thermal-overload conditions.

Thermal-overload protection is designed to protect the MAX8867/MAX8868 in the event of fault conditions. For continual operation, do not exceed the absolute maximum junction-temperature rating of $T_J = +150^\circ\text{C}$.

Operating Region and Power Dissipation

The MAX8867/MAX8868's maximum power dissipation depends on the thermal resistance of the case and circuit board, the temperature difference between the die junction and ambient air, and the rate of air flow. The power dissipation across the device is $P = I_{\text{OUT}} (V_{\text{IN}} - V_{\text{OUT}})$. The maximum power dissipation is:

$$P_{\text{MAX}} = (T_J - T_A) / (\theta_{\text{JB}} + \theta_{\text{BA}})$$

where $T_J - T_A$ is the temperature difference between the MAX8867/MAX8868 die junction and the surrounding air, θ_{JB} (or θ_{JC}) is the thermal resistance of the package, and θ_{BA} is the thermal resistance through the printed circuit board, copper traces, and other materials to the surrounding air.

The GND pin of the MAX8867/MAX8868 performs the dual function of providing an electrical connection to ground and channeling heat away. Connect the GND pin to ground using a large pad or ground plane.

Reverse Battery Protection

The MAX8867/MAX8868 have a unique protection scheme that limits the reverse supply current to 1mA when either V_{IN} or V_{SHDN} falls below ground. Their circuitry monitors the polarity of these two pins and disconnects the internal circuitry and parasitic diodes when the battery is reversed. This feature prevents device damage.

Noise Reduction

An external 0.01 μ F bypass capacitor at BP, in conjunction with an internal 200k Ω resistor, creates an 80Hz lowpass filter for noise reduction. The MAX8867/MAX8868 exhibit 30 μ V_{RMS} of output voltage noise with $C_{\text{BP}} = 0.01\mu\text{F}$ and $C_{\text{OUT}} = 10\mu\text{F}$. Start-up time is minimized by a power-on circuit that pre-charges the bypass capacitor. The *Typical Operating Characteristics* show graphs of Noise vs. BP Capacitance, Noise vs. Load Current, and Output Noise Spectral Density.

Applications Information

Capacitor Selection and Regulator Stability

Normally, use a 1 μ F capacitor on the MAX8867/MAX8868's input and a 1 μ F to 10 μ F capacitor on the output. Larger input capacitor values and lower ESRs provide better supply-noise rejection and line-transient response. Reduce noise and improve load-transient response, stability, and power-supply rejection by using large output capacitors. For stable operation over the full temperature range and with load currents up to 150mA, a minimum of 1 μ F is recommended. Note that some ceramic dielectrics exhibit large capacitance and ESR variation with temperature. With dielectrics such as

Low-Noise, Low-Dropout, 150mA Linear Regulators in SOT23

Z5U and Y5V, it may be necessary to use 2.2 μ F or more to ensure stability at temperatures below -10°C. With X7R or X5R dielectrics, 1 μ F should be sufficient at all operating temperatures. Also, for high-ESR tantalum capacitors, 2.2 μ F or more may be needed to maintain ESR in the stable region. A graph of the Region of Stable C_{OUT} ESR vs. Load Current is shown in the *Typical Operating Characteristics*.

Use a 0.01 μ F bypass capacitor at BP for low output voltage noise. Increasing the capacitance will slightly decrease the output noise, but increase the start-up time. Values above 0.1 μ F provide no performance advantage and are not recommended (see Shutdown Exit Delay graph in the *Typical Operating Characteristics*).

PSRR and Operation from Sources Other than Batteries

The MAX8867/MAX8868 are designed to deliver low dropout voltages and low quiescent currents in battery-powered systems. Power-supply rejection is 63dB at low frequencies and rolls off above 10kHz. See the Power-Supply Rejection Ratio Frequency graph in the *Typical Operating Characteristics*.

When operating from sources other than batteries, improved supply-noise rejection and transient response can be achieved by increasing the values of the input and output bypass capacitors, and through passive filtering techniques. The *Typical Operating Characteristics*

show the MAX8867/MAX8868's line- and load-transient responses.

Load-Transient Considerations

The MAX8867/MAX8868 load-transient response graphs (see *Typical Operating Characteristics*) show two components of the output response: a DC shift from the output impedance due to the load current change, and the transient response. A typical transient for a step change in the load current from 0mA to 50mA is 12mV. Increasing the output capacitor's value and decreasing the ESR attenuates the overshoot.

Input-Output (Dropout) Voltage

A regulator's minimum input-output voltage differential (or dropout voltage) determines the lowest usable supply voltage. In battery-powered systems, this will determine the useful end-of-life battery voltage. Because the MAX8867/MAX8868 use a P-channel MOSFET pass transistor, their dropout voltage is a function of drain-to-source on-resistance ($R_{DS(ON)}$) multiplied by the load current (see *Typical Operating Characteristics*).

Chip Information

TRANSISTOR COUNT: 247

SUBSTRATE CONNECTED TO GND

Expanded Ordering Information

| OUTPUT VOLTAGE (xy) CODE | | PRESET OUTPUT VOLTAGE (V) | SOT TOP MARK | | | |
|--------------------------|----------------|---------------------------|-----------------|--------------|-----------------|--------------|
| REGULAR SOT23 | THIN SOT23 | | MAX8867 REGULAR | MAX8867 THIN | MAX8868 REGULAR | MAX8868 THIN |
| MAX886_EUK25-T | MAX886_EZK25-T | 2.50 | ACAY | ADQM | ACBF | ADQW |
| MAX886_EUK28-T | MAX886_EZK28-T | 2.80 | ACAZ | ADQO | ACBG | ADQX |
| MAX886_EUK29-T | MAX886_EZK29-T | 2.84 | ACBA | ADQP | ACBH | ADQY |
| MAX886_EUK30-T | MAX886_EZK30-T | 3.00 | ACBB | ADQQ | ACBI | ADQZ |
| MAX886_EUK32-T | MAX886_EZK32-T | 3.15 | ACBC | ADQR | ACBJ | ADRA |
| MAX886_EUK33-T | MAX886_EZK33-T | 3.30 | ACBD | ADQS | ACBK | ADRB |
| MAX886_EUK36-T | MAX886_EZK36-T | 3.60 | ACCZ | ADQT | ACDA | ADRC |
| MAX886_EUK50-T | MAX886_EZK50-T | 5.00 | ACBE | ADQV | ACBL | ADRD |
| Other xy*** | | x.y0 | — | — | — | — |

***Other xy between 2.5V and 5.0V are available in 100mV increments. Contact factory for other versions. Minimum order quantity is 25,000 units.

Low-Noise, Low-Dropout, 150mA Linear Regulators in SOT23

Package Information

(The package drawing(s) in this data sheet may not reflect the most current specifications. For the latest package outline information, go to www.maxim-ic.com/packages.)

MAX8867/MAX8868

SOTBLEFS

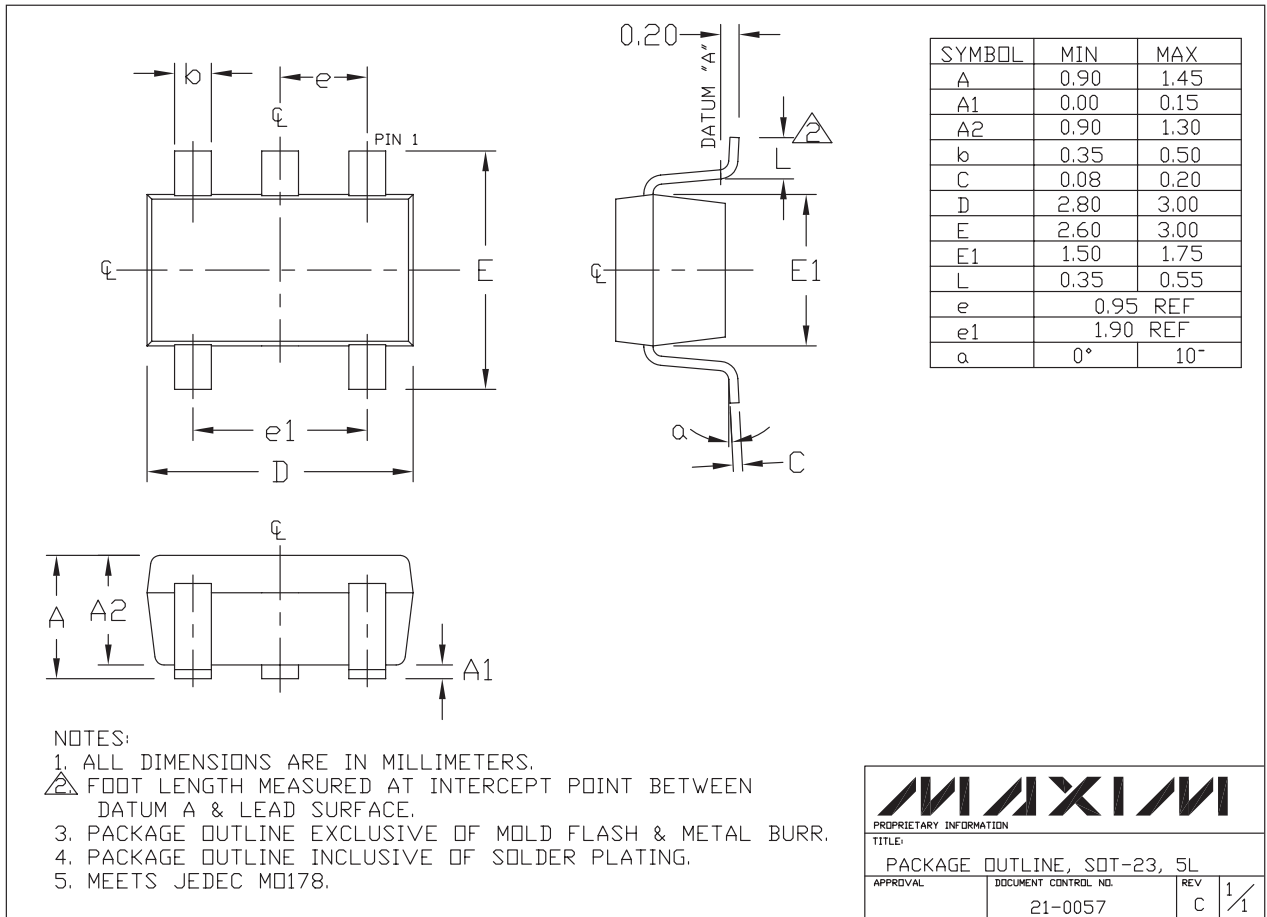

Low-Noise, Low-Dropout, 150mA Linear Regulators in SOT23

Package Information (continued)

(The package drawing(s) in this data sheet may not reflect the most current specifications. For the latest package outline information, go to www.maxim-ic.com/packages.)

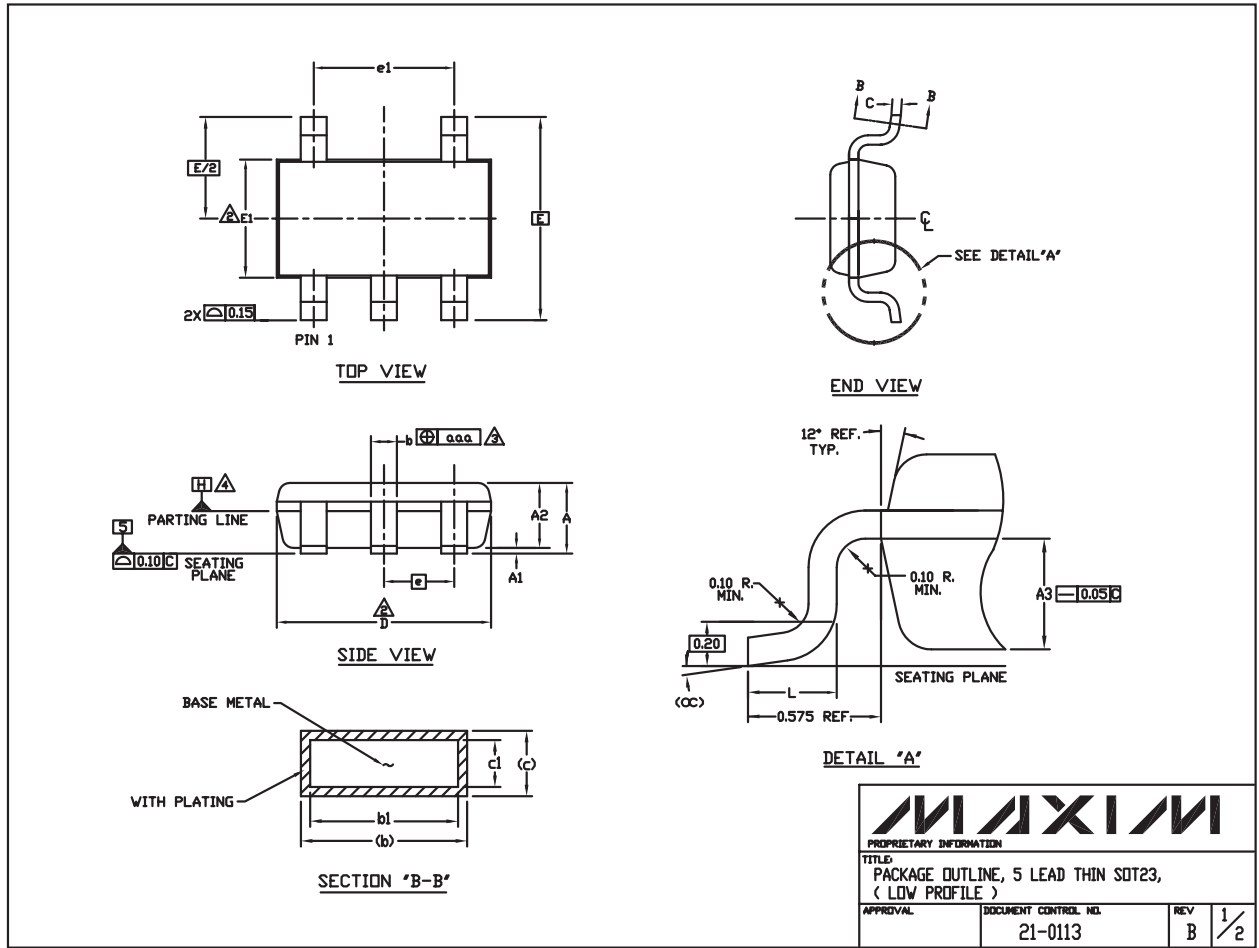

THIN SOT23.EPS

Low-Noise, Low-Dropout, 150mA Linear Regulators in SOT23

Package Information (continued)

(The package drawing(s) in this data sheet may not reflect the most current specifications. For the latest package outline information, go to www.maxim-ic.com/packages.)

MAX8867/MAX8868

NOTES:

1. ALL DIMENSIONS ARE IN MILLIMETERS.

② "D" AND "E1" ARE REFERENCE DATUM AND DO NOT INCLUDE MOLD FLASH OR PROTRUSIONS, AND ARE MEASURED AT THE BOTTOM PARTING LINE. MOLD FLASH OR PROTRUSION SHALL NOT EXCEED 0.15mm ON "D" AND 0.25mm ON "E" PER SIDE.

③ THE LEAD WIDTH DIMENSION DOES NOT INCLUDE DAMBAR PROTRUSION. ALLOWABLE DAMBAR PROTRUSION SHALL BE 0.07mm TOTAL IN EXCESS OF THE LEAD WIDTH DIMENSION AT MAXIMUM MATERIAL CONDITION.

④ DATUM PLANE "H" LOCATED AT MOLD PARTING LINE AND COINCIDENT WITH LEAD, WHERE LEAD EXITS PLASTIC BODY AT THE BOTTOM OF PARTING LINE.

⑤ THE LEAD TIPS MUST LINE WITHIN A SPECIFIED TOLERANCE ZONE. THIS TOLERANCE ZONE IS DEFINED BY TWO PARALLEL LINES. ONE PLANE IS THE SEATING PLANE, DATUM [-C-]; AND THE OTHER PLANE IS AT THE SPECIFIED DISTANCE FROM [-C-] IN THE DIRECTION INDICATED. FORMED LEADS SHALL BE PLANAR WITH RESPECT TO ONE ANOTHER WITH 0.10mm AT SEATING PLANE.

6. THIS PART IS COMPLIANT WITH JEDEC SPECIFICATION MO-193 EXCEPT FOR THE "e" DIMENSION WHICH IS 0.95mm INSTEAD OF 1.00mm. THIS PART IS IN FULL COMPLIANCE TO EIAJ SPECIFICATION SC-74.

| SYMBOLS | | | |
|---------|----------|-------|------|
| | MIN | NOM | MAX |
| A | - | - | 1.10 |
| A1 | 0.05 | 0.075 | 0.10 |
| A2 | 0.85 | 0.88 | 0.90 |
| A3 | 0.50 BSC | | |
| b | 0.30 | - | 0.45 |
| b1 | 0.25 | 0.35 | 0.40 |
| c | 0.15 | - | 0.20 |
| c1 | 0.12 | 0.127 | 0.15 |
| D | 2.80 | 2.90 | 3.00 |
| E | 2.75 BSC | | |
| E1 | 1.55 | 1.60 | 1.65 |
| L | 0.30 | 0.40 | 0.50 |
| e1 | 1.90 BSC | | |
| e | 0.95 BSC | | |
| CC | 0° | 4° | 8° |
| aaa | 0.20 | | |

| | | | |
|---|--|-------------------------|--------------------|
|  | | | |
| <small>PROPRIETARY INFORMATION</small> | | | |
| <small>TITLE</small> PACKAGE OUTLINE, 5 LEAD THIN SOT23, (LOW PROFILE) | | | |
| <small>APPROVAL</small> | <small>DOCUMENT CONTROL NO.</small> 21-0113 | <small>REV</small> B | <small>2/2</small> |

Maxim cannot assume responsibility for use of any circuitry other than circuitry entirely embodied in a Maxim product. No circuit patent licenses are implied. Maxim reserves the right to change the circuitry and specifications without notice at any time.

Maxim Integrated Products, 120 San Gabriel Drive, Sunnyvale, CA 94086 408-737-7600 _____ 11