

MAX9541/MAX9542

Quadruple, 2:1, Mux Amplifiers for Standard-Definition and VGA Signals

General Description

The MAX9541/MAX9542 are quadruple-channel, 2:1 video mux amplifiers with input sync tip clamps. These devices select between two video sources and support up to four channels on each source. The MAX9541 has integrated lowpass filters that are optimized for standard-definition video signals such as composite and red, green, blue (RGB). The filters typically have $\pm 1\text{dB}$ passband flatness out to 9.5MHz and 47dB attenuation at 27MHz. The MAX9542 has a wider bandwidth of 15MHz because it does not have integrated lowpass filters, making it suitable for not only standard-definition video signals, but also video graphics array (VGA) signals with a 640 x 480 resolution at up to 85Hz refresh rate.

Video signals are AC-coupled to the inputs of the MAX9541/MAX9542. The input sync-tip clamps set the internal DC level.

The amplifiers have 2V/V gain, and the outputs can be DC-coupled to a 75 Ω load, which is the equivalent of two video loads, or AC-coupled to a 150 Ω load.

Both the MAX9541/MAX9542 feature a low-power shutdown mode, in which supply current is reduced to 35 μA .

Applications

- Industrial

Functional Diagram

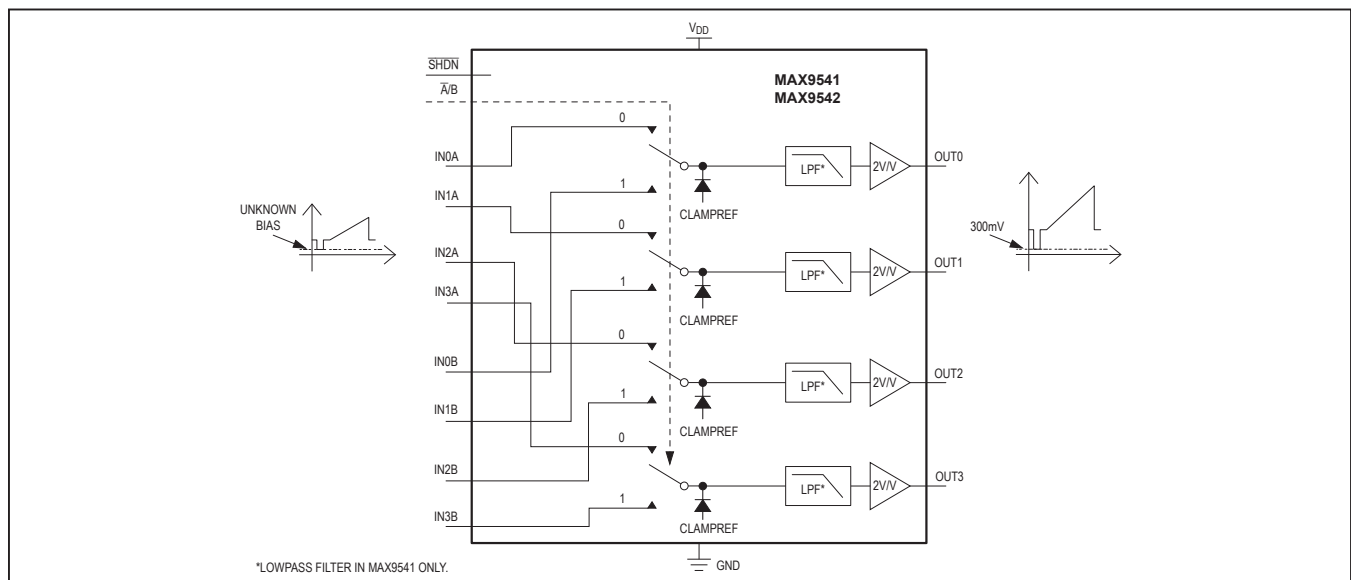

Features

- Quad 2:1 Video Mux Amplifiers
- Reconstruction Filters with 9.5MHz Passband and 47dB Attenuation at 27MHz (MAX9541)
- Fixed Gain of 2V/V
- Input Sync-Tip Clamps
- Shutdown
- 2.7V to 3.6V Single-Supply Operation

Ordering Information

PART	PIN-PACKAGE	STANDARD-DEFINITION VIDEO FILTER
MAX9541AEE+	16 QSOP	Yes
MAX9542AEE+	16 QSOP	No

Note: All devices are specified over the -40°C to +125°C operating temperature range.

+Denotes a lead(Pb)-free/RoHS-compliant package.

Absolute Maximum Ratings

Supply Voltage		Continuous Power Dissipation (T _A = +70°C)
V _{DD} to GND.....	-0.3V to +4V	16-Pin QSOP (derate 8.3mW/°C above +70°C).....
Input Pins, $\overline{\text{SHDN}}$, $\overline{\text{A/B}}$	(GND - 0.3V) to +4V	Operating Temperature Range.....
Duration of Output Short Circuit to V _{DD} or GND	Continuous	Junction Temperature.....
Continuous Input Current		Storage Temperature Range
Input Pins.....	±20mA	Lead Temperature (soldering, 10s)

Stresses beyond those listed under "Absolute Maximum Ratings" may cause permanent damage to the device. These are stress ratings only, and functional operation of the device at these or any other conditions beyond those indicated in the operational sections of the specifications is not implied. Exposure to absolute maximum rating conditions for extended periods may affect device reliability.

Electrical Characteristics

(V_{DD} = 3.3V, V_{GND} = 0, $\overline{\text{SHDN}}$ = V_{DD}, $\overline{\text{A/B}}$ = V_{DD}, R_L = 150Ω to GND, T_A = T_{MIN} to T_{MAX}, unless otherwise noted. Typical values are at T_A = +25°C.) (Note 1)

PARAMETER	SYMBOL	CONDITIONS		MIN	TYP	MAX	UNITS
Supply Voltage Range	V _{DD}	Guaranteed by power-supply rejection test		2.7	3.3	3.6	V
Quiescent Supply Current	I _{DD}	No load			21	45	mA
Shutdown Supply Current	I _{SHDN}	$\overline{\text{SHDN}} = \overline{\text{A/B}} = \text{GND}$			35	70	μA
Input Voltage		Unselected input			V _{DD} /3		V
Input Resistance		Unselected input			222		kΩ
Sync-Tip Clamp Level	V _{CCLP}			0.23	0.3	0.39	V
Input Voltage Range		Guaranteed by DC voltage gain	2.7V ≤ V _{DD} ≤ 3.6V			1.05	V _{P-P}
			3.0V ≤ V _{DD} ≤ 3.6V			1.2	
Sync Crush		Sync-tip clamp; percentage reduction in sync pulse (0.3V _{P-P}); guaranteed by input clamping current measurement				2	%
Input Clamping Current					1	2	μA
Maximum Input Source Resistance					300		Ω
DC Voltage Gain (Note 2)	A _V	R _L = 150Ω to GND (Note 2)	V _{DD} = 2.7V, 0V ≤ V _{IN} ≤ 1.05V	1.96	2	2.04	V/V
			V _{DD} = 3V, 0V ≤ V _{IN} ≤ 1.2V	1.96	2	2.04	
DC Gain Mismatch		Guaranteed by DC voltage gain		-2		+2	%
Output Level		Measured at V _{OUT} , C _{IN_} = 0.1μF to GND		0.218	0.3	0.39	V
Output Voltage Swing		Measured at output, V _{DD} = 2.7V, V _{IN} = V _{CCLP} to (V _{CCLP} + 1.05V), R _L = 150Ω to -0.2V			2.1		V _{P-P}
		Measured at output, V _{DD} = 2.7V, V _{IN} = V _{CCLP} to (V _{CCLP} + 1.05V), R _L = 150Ω to V _{DD} /2			2.1		
		Measured at output, V _{DD} = 3.0V, V _{IN} = V _{CCLP} to (V _{CCLP} + 1.2V), R _L = 150Ω to -0.2V			2.4		
		Measured at output, V _{DD} = 3.0V, V _{IN} = V _{CCLP} to (V _{CCLP} + 1.2V), R _L = 150Ω to V _{DD} /2			2.4		
		Measured at output, V _{DD} = 3.135V, V _{IN} = V _{CCLP} to (V _{CCLP} + 1.05V), R _L = 75Ω to -0.2V			2.1		
Output Short-Circuit Current		Short to GND (sourcing)			140		mA
		Short to V _{DD} (sinking)			70		
Output Resistance	R _{OUT}	V _{OUT} = 1.5V, -10mA ≤ I _{LOAD} ≤ +10mA			0.2		Ω

Electrical Characteristics (continued)

($V_{DD} = 3.3V$, $V_{GND} = 0$, $\overline{SHDN} = V_{DD}$, $\overline{A/B} = V_{DD}$, $R_L = 150\Omega$ to GND, $T_A = T_{MIN}$ to T_{MAX} , unless otherwise noted. Typical values are at $T_A = +25^\circ C$.) (Note 1)

PARAMETER	SYMBOL	CONDITIONS	MIN	TYP	MAX	UNITS	
Power-Supply Rejection Ratio		$2.7V \leq V_{DD} \leq 3.6V$	48	64		dB	
		$f = 100kHz$, $100mV_{P-P}$		20			
Small-Signal Bandwidth		$V_{OUT} = 100mV_{P-P}$ (MAX9542 only)		27		MHz	
Large-Signal Bandwidth		$V_{OUT} = 2V_{P-P}$ (MAX9542 only)		15		MHz	
Slew Rate		MAX9542 only		65		V/ μs	
Settling Time		Settled to within 0.1% of final value (MAX9542 only)		75		ns	
Standard-Definition Reconstruction Filter		$V_{OUT} = 2V_{P-P}$, reference frequency is 100kHz, $\pm 1dB$ passband flatness (MAX9541 only)		9.5		MHz	
		$V_{OUT} = 2V_{P-P}$, reference frequency is 100kHz (MAX9541 only)	$f = 5.5MHz$		0.1		dB
			$f = 9.5MHz$		-1		
			$f = 10MHz$		-3		
			$f = 27MHz$		-47		
Differential Gain	DG	5-step modulated staircase of 129mV step size and 286mV peak-to-peak subcarrier amplitude, $f = 4.43MHz$		0.4		%	
Differential Phase	DP	5-step modulated staircase of 129mV step size and 286mV peak-to-peak subcarrier amplitude, $f = 4.43MHz$		0.45		deg	
Group-Delay Distortion		$100kHz \leq f \leq 5MHz$, outputs are $2V_{P-P}$		9		ns	
Peak Signal to RMS Noise		$100kHz \leq f \leq 5MHz$		71		dB	
2T Pulse Response		$2T = 200ns$		0.2		K%	
2T Bar Response		$2T = 200ns$; bar time is 18 μs ; the beginning 2.5%, and the ending 2.5% of the bar time is ignored		0.2		K%	
2T Pulse-to-Bar K Rating		$2T = 200ns$; bar time is 18 μs ; the beginning 2.5%, and the ending 2.5% of the bar time is ignored		0.3		K%	
Nonlinearity		5-step staircase		0.1		%	
Output Impedance		$f = 5.5MHz$		8.07		Ω	
All-Hostile Crosstalk		$f = 15kHz$		-82		dB	
		$f = 4.43MHz$		-78			
Output-to-Input Crosstalk		$f = 30MHz$		-68		dB	
LOGIC SIGNALS (TV_SEL, VCR_SEL, \overline{SHDN})							
Logic-Low Threshold	V_{IL}			$0.3 \times V_{DD}$		V	
Logic-High Threshold	V_{IH}			$0.7 \times V_{DD}$		V	
Logic-Input Current	I_{IN}			10		μA	

Note 1: All devices are 100% production tested at $T_A = +25^\circ C$. Specifications over temperature limits are guaranteed by design.

Note 2: Voltage gain (A_V) is a two-point measurement in which the output-voltage swing is divided by the input-voltage swing.

Typical Operating Characteristics (MAX9541)

($V_{DD} = 3.3V$, $V_{GND} = 0$, $\overline{SHDN} = V_{DD}$, $\overline{A/B} = V_{DD}$, $R_L = 150\Omega$ to GND, $T_A = +25^\circ C$.)

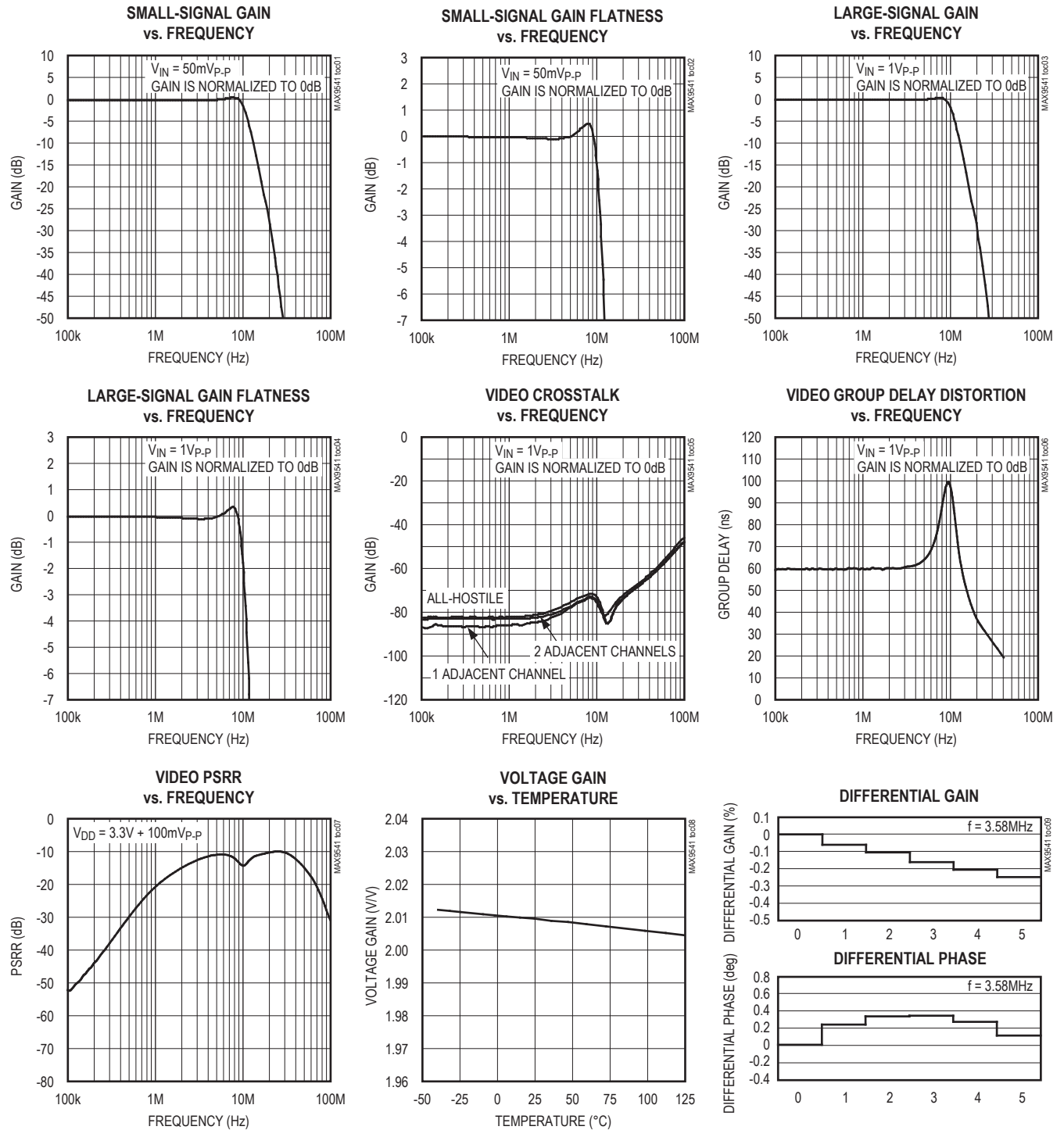

Typical Operating Characteristics (continued) (MAX9541)

($V_{DD} = 3.3V$, $V_{GND} = 0$, $\overline{SHDN} = V_{DD}$, $\overline{A/B} = V_{DD}$, $R_L = 150\Omega$ to GND, $T_A = +25^\circ C$.)

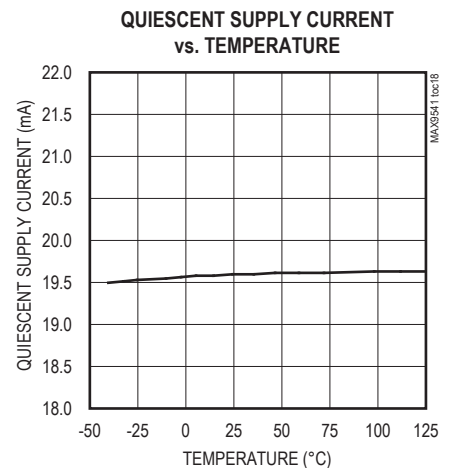
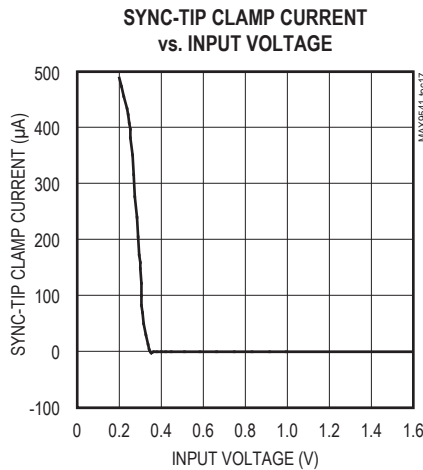
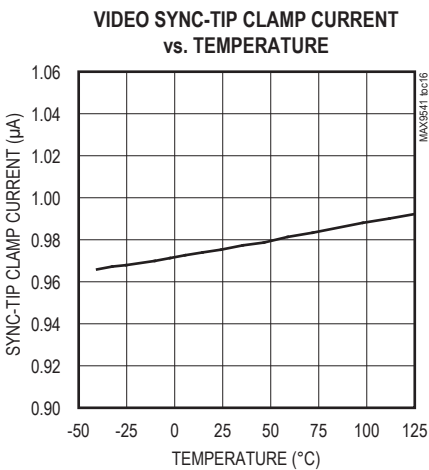
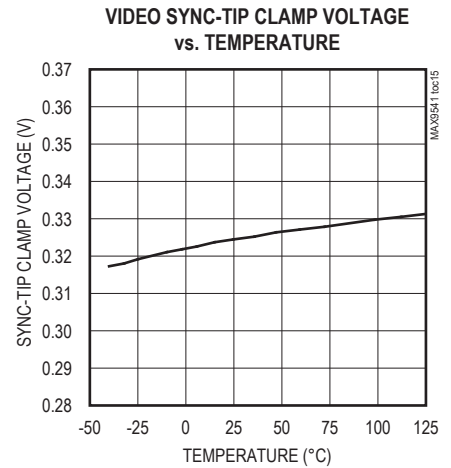
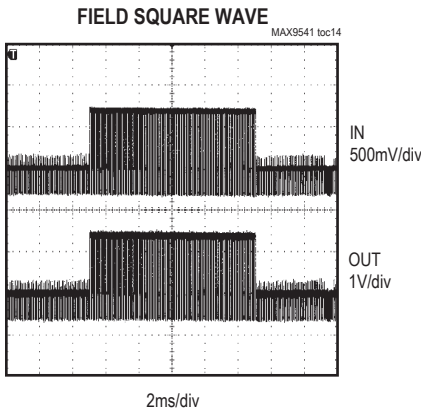
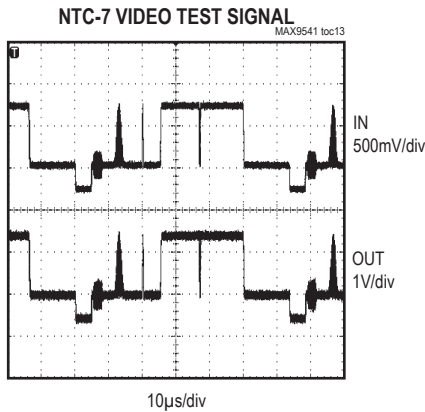
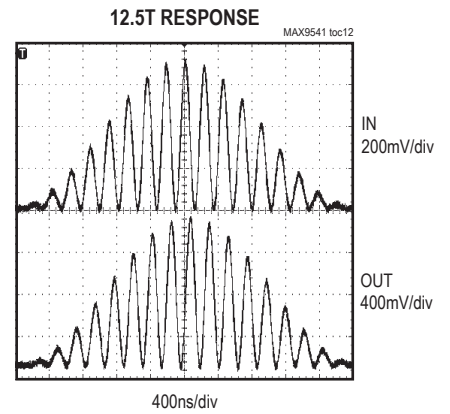
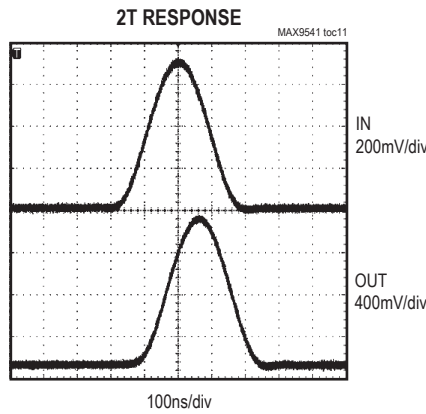
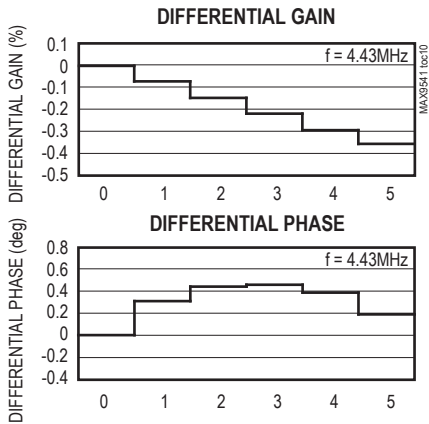

Typical Operating Characteristics (continued) (MAX9542)

($V_{DD} = 3.3V$, $V_{GND} = 0$, $\overline{SHDN} = V_{DD}$, $\overline{A/B} = V_{DD}$, $R_L = 150\Omega$ to GND, $T_A = +25^\circ C$.)

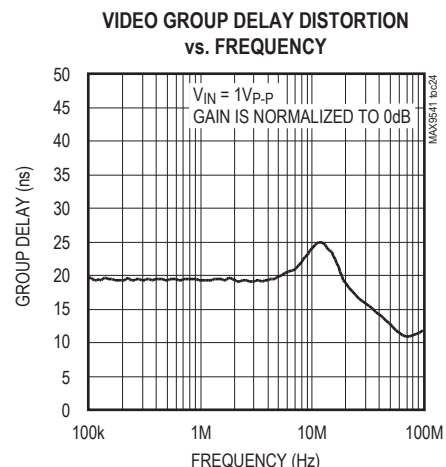
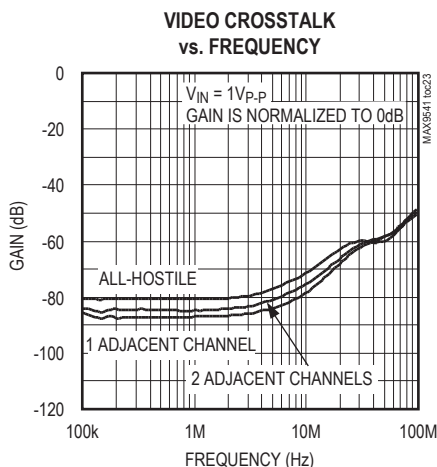
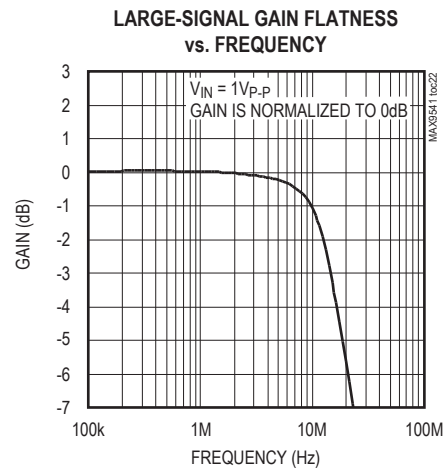
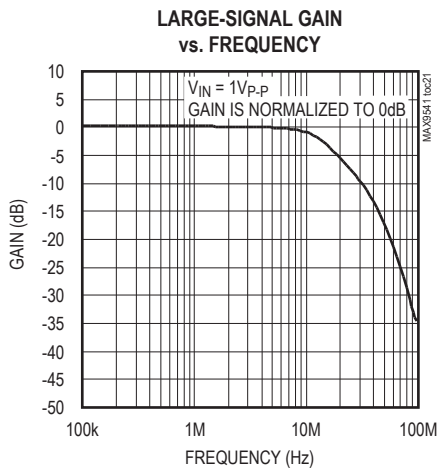
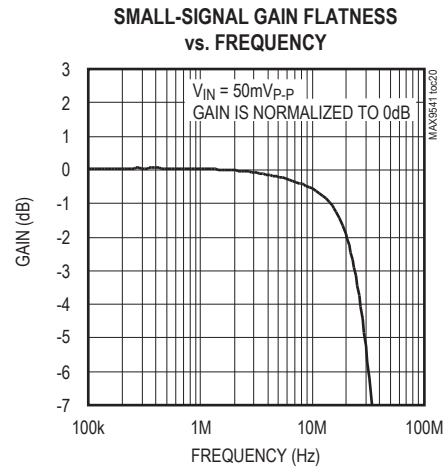
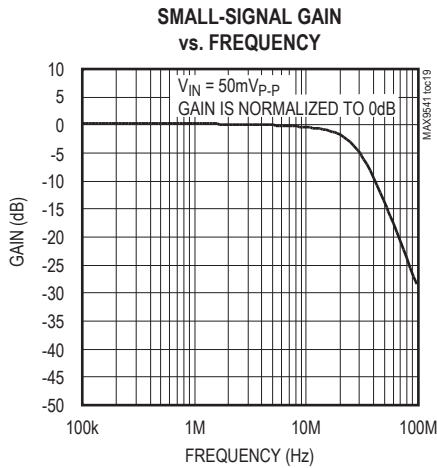

Typical Operating Characteristics (continued) (MAX9542)

($V_{DD} = 3.3V$, $V_{GND} = 0$, $\overline{SHDN} = V_{DD}$, $\overline{A/B} = V_{DD}$, $R_L = 150\Omega$ to GND, $T_A = +25^\circ C$.)

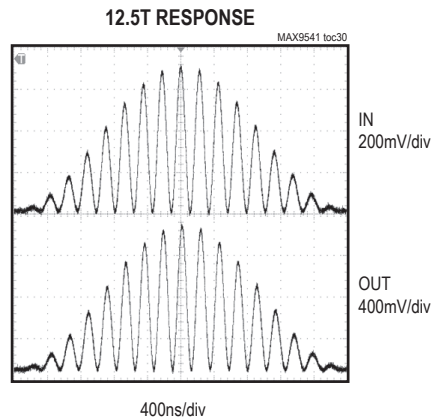
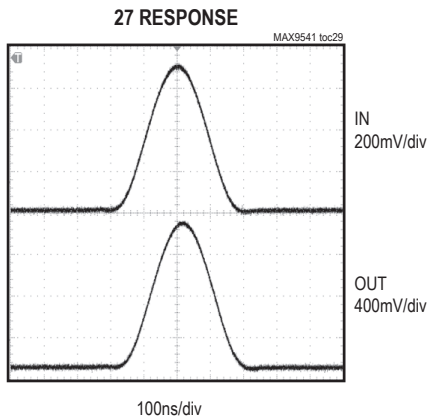
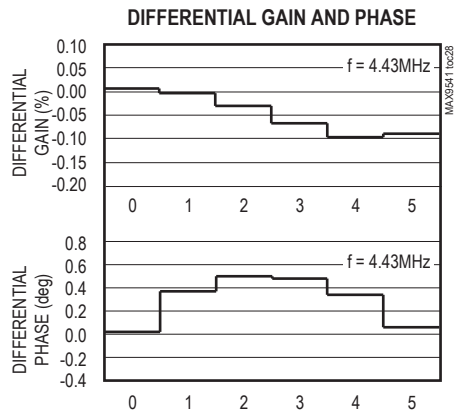
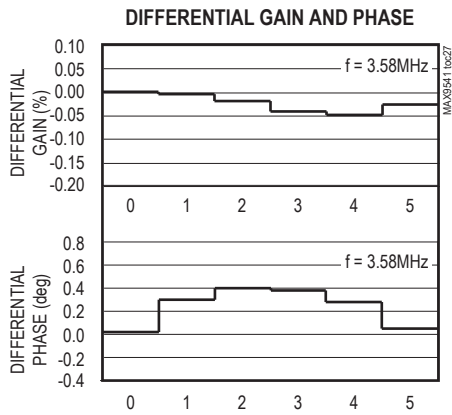
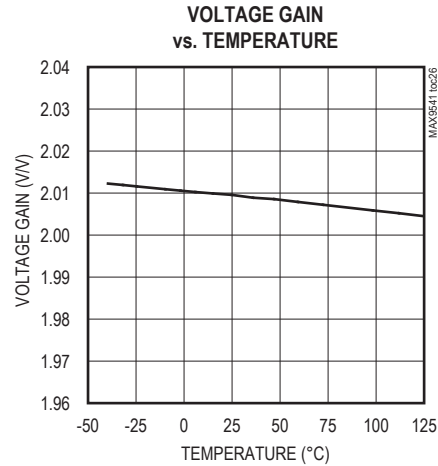
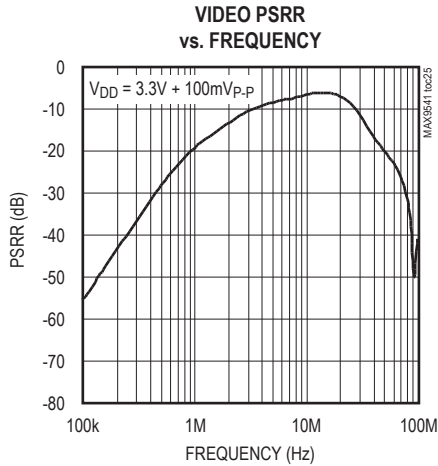

Typical Operating Characteristics (continued) (MAX9542)

($V_{DD} = 3.3V$, $V_{GND} = 0$, $\overline{SHDN} = V_{DD}$, $\overline{A/B} = V_{DD}$, $R_L = 150\Omega$ to GND, $T_A = +25^\circ C$.)

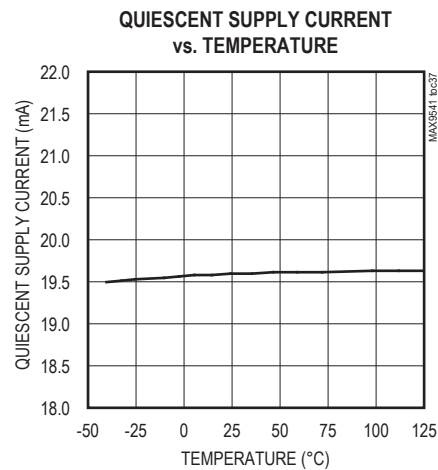
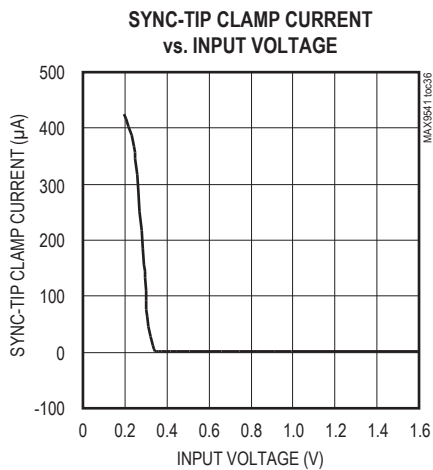
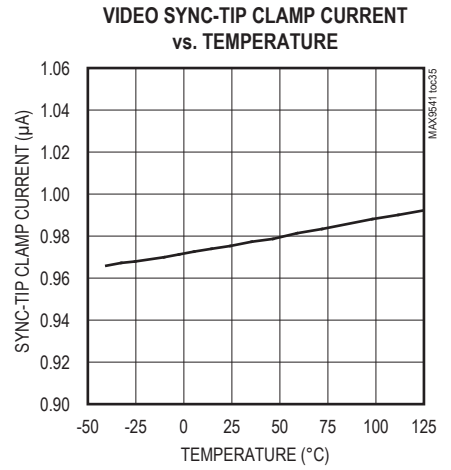
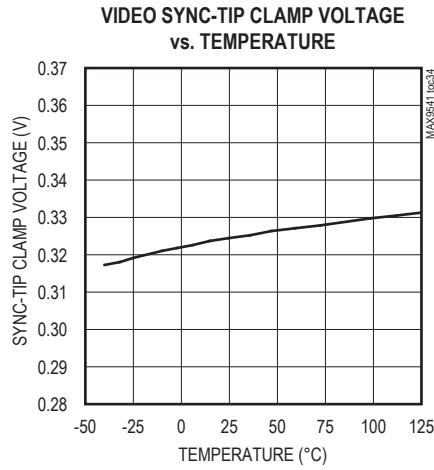
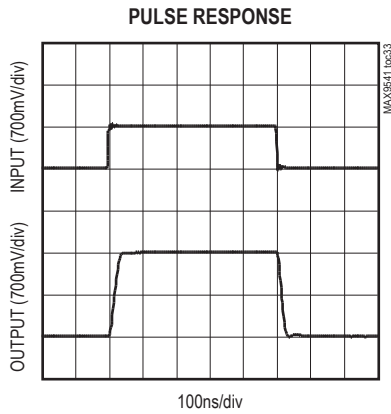
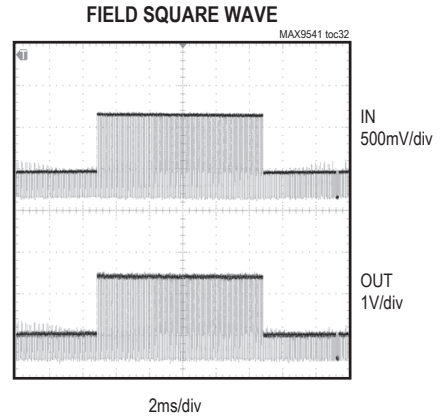
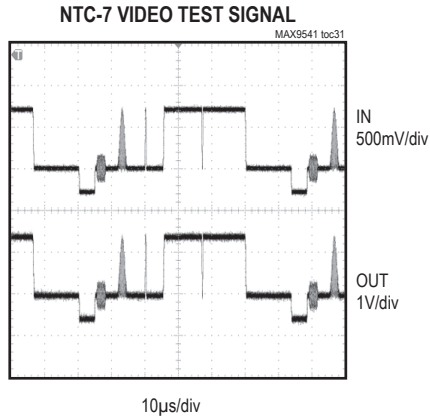

Pin Description

PIN	NAME	FUNCTION
1	IN0A	Video Input A Channel 0
2	IN1A	Video Input A Channel 1
3	IN2A	Video Input A Channel 2
4	IN3A	Video Input A Channel 3
5	IN0B	Video Input B Channel 0
6	IN1B	Video Input B Channel 1
7	IN2B	Video Input B Channel 2
8	IN3B	Video Input B Channel 3
9	GND	Ground
10	$\overline{\text{SHDN}}$	Shutdown Logic Input. Connect to GND to place the device in shutdown. Connect to V_{DD} for normal operation.
11	OUT3	Video Output Channel 3
12	OUT2	Video Output Channel 2
13	OUT1	Video Output Channel 1
14	OUT0	Video Output Channel 0
15	$\overline{\text{A/B}}$	Input Select. Connect to GND to select Video Input A as the video source. Connect to V_{DD} to select Video Input B as the video source.
16	V_{DD}	Positive Power Supply. Bypass to GND with a 0.1 μF capacitor.

Detailed Description

The MAX9541 selects between two standard-definition video sources that can each have up to four video signals, for example, RGB with composite sync (RGBS) or RGB with sync-on-green. See Figure 1. It is also possible to select between two sets of four composite video signals with blanking and sync (CVBS). With its integrated low-pass filter (10MHz large-signal -3dB bandwidth typical), the MAX9541 can provide the anti-alias filtering before an analog-to-digital converter (ADC) or the reconstruction filtering after a digital-to-analog converter (DAC). The incoming video signals can have any DC bias because the MAX9541 has input sync-tip clamps which restore

the DC level. The output amplifiers have a gain of 2V/V. The MAX9541 operates from a single 3.3V supply and consumes low quiescent power and low average power. In addition, the device also has shutdown mode.

The MAX9542 is similar to the MAX9541 except that it does not have the integrated lowpass filter. As a result, the typical, large-signal bandwidth of the MAX9541 is 15MHz. Therefore, it can select between two video sources that can each have up to four video signals that are standard definition or VGA. A standard-definition signal set would be RGB with composite sync. A VGA signal set would be RGB with a 640 x 480 resolution and up to 85Hz refresh rate. See Figure 2.

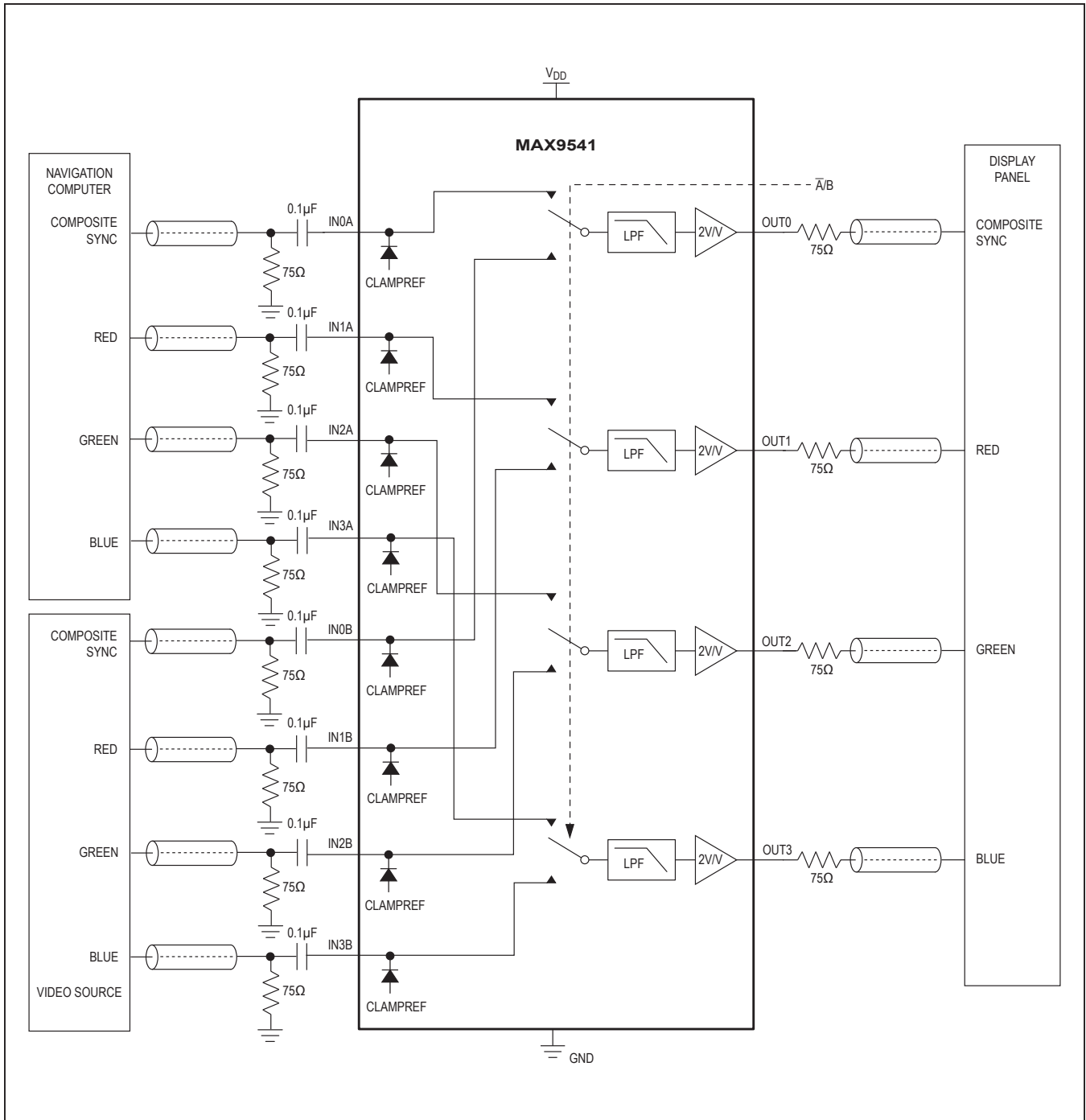

Figure 1. The MAX9541 selects between two sources of RGB with composite sync, filters the signals, and drives the signals into a display panel.

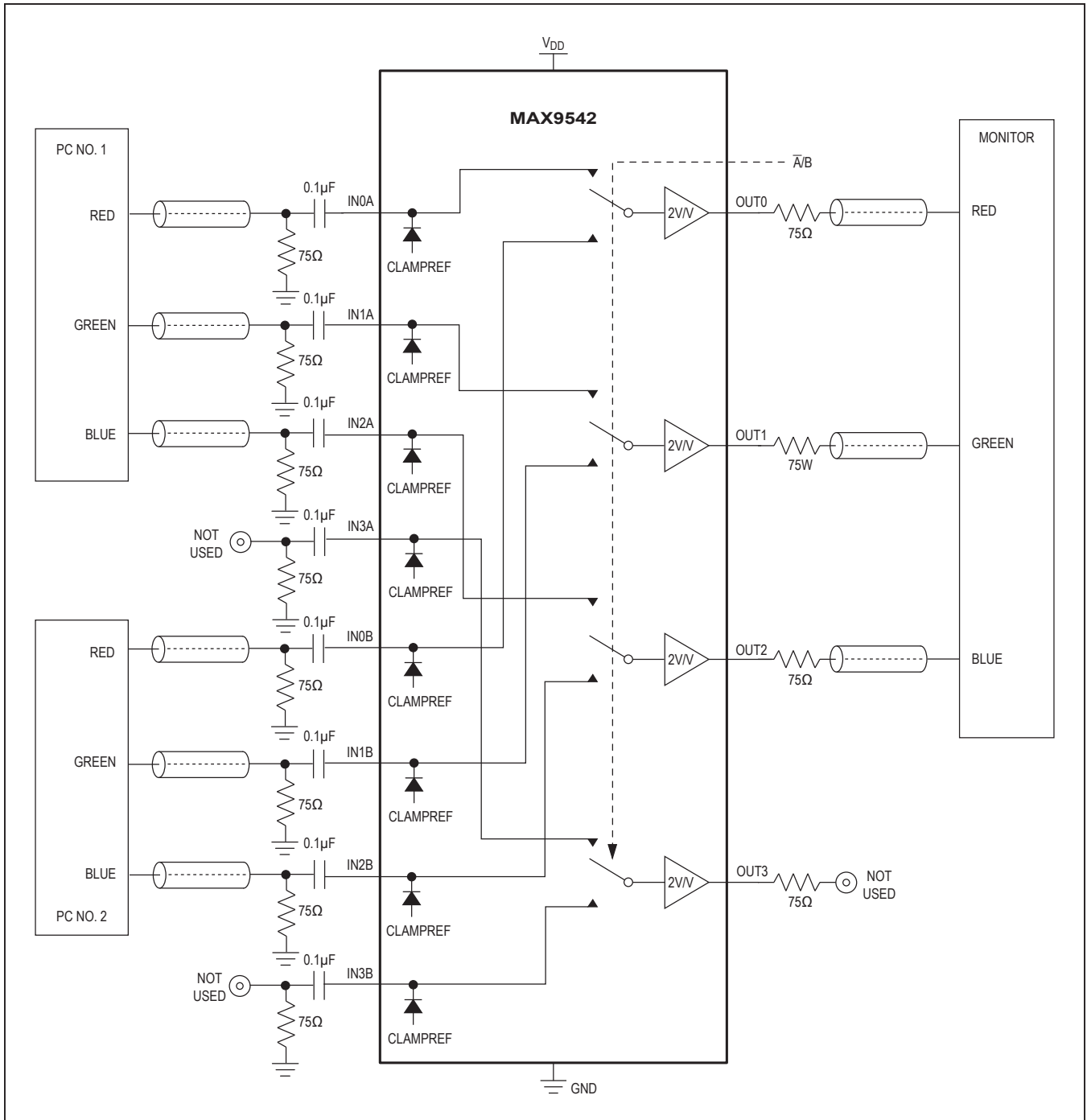

Figure 2. The MAX9542 Selecting Between Two VGA Sources

Operating Modes

$\overline{A/B}$ controls whether Video Input A or Video Input B is selected. See Table 1.

\overline{SHDN} controls whether the device is on or off. See Table 2. In shutdown, the outputs are in high impedance.

Input

Each video source can provide up to four video signals. Every video signal must be AC-coupled to the MAX9541/MAX9542 through 0.1 μ F capacitors. The MAX9541/MAX9542 have sync-tip clamps and bias circuits to restore the DC level of the video signal after the input coupling capacitor. When a video input is selected, the input has a sync-tip clamp, which accepts video signals that have sync pulses or that reach their minimum level during sync. Composite video with blanking and sync (CVBS) is an example of a video signal with sync pulses. The red, green, and blue signals in an RGBS signal set are examples of signals that return to their blank level during sync. The sync-tip voltage is internally set to 300mV.

When a video input is not selected, the inputs to the MAX9541/MAX9542 do not distort the video signal in case the video source is driving video signals to another video circuit such as a video multiplexer. The inputs are biased at $V_{DD}/3$, which is sufficiently above ground so that the ESD diodes never forward bias as the video signal changes. The input resistance is 220k Ω , which presents negligible loading on the video current DAC. The sole exception to this condition is IN3A, in which the input circuit is always a sync-tip clamp. Table 3 summarizes which input circuit is active, dependent upon $\overline{A/B}$.

In shutdown mode ($\overline{SHDN} = \text{LOW}$), a bias circuit is active on every input.

Table 1. $\overline{A/B}$ Logic

LOGIC STATE	MODE
Low	Video Input A
High	Video Input B

Table 2. \overline{SHDN} Logic

LOGIC STATE	MODE
Low	Off
High	On

Multiplexer

The MAX9541/MAX9542 have quadruple 2:1 multiplexers to select between either Video Input A or Video Input B as the source of the video signal. When $\overline{A/B}$ is connected to GND, Video Input A is the video source. When $\overline{A/B}$ is connected to V_{DD} , Video Input B is the video source.

Video Filter

The MAX9541 filter features ± 1 dB passband out to 9.5MHz and 47dB attenuation at 27MHz, making the filter suitable for standard-definition video signals from all sources (e.g., broadcast and DVD). Broadcast video signals are channel limited: NTSC signals have 4.2MHz bandwidth, and PAL signals have 5MHz bandwidth. Video signals from a DVD player, however, are not channel limited; so the bandwidth of DVD video signals can approach the Nyquist limit of 6.75MHz. Recommendation: ITU-R BT.601-5 specifies 13.5MHz as the sampling rate for standard-definition video. Therefore, the maximum bandwidth of the signal is 6.75MHz. To ease the filtering requirements, most modern video systems oversample by two times, clocking the video current DAC at 27MHz.

The MAX9542 does not have a filter.

Table 3. Input Circuit of Input as Determined by State of $\overline{A/B}$ ($\overline{SHDN} = \text{HIGH}$)

INPUT	INPUT CIRCUIT $\overline{A/B} = \text{LOW}$	INPUT CIRCUIT $\overline{A/B} = \text{HIGH}$
IN0A	Sync-tip clamp	Bias
IN1A	Sync-tip clamp	Bias
IN2A	Sync-tip clamp	Bias
IN3A	Sync-tip clamp	Sync-tip clamp
IN0B	Bias	Sync-tip clamp
IN1B	Bias	Sync-tip clamp
IN2B	Bias	Sync-tip clamp
IN3B	Bias	Sync-tip clamp

Table 4. Quiescent and Average Power Consumption

MEASUREMENT	POWER CONSUMPTION (mW)	CONDITIONS
Quiescent power consumption	69	No load.
Average power consumption	175	150Ω to ground on each output. 50% flat field signal on each input.

Outputs

The video output amplifiers can both source and sink load current, allowing output loads to be DC- or AC-coupled. The amplifier output stage needs approximately 300mV of headroom from either supply rail. The devices have an internal level-shift circuit that positions the sync tip at approximately 300mV at the output.

If the supply voltage is greater than 3.135V (5% below a 3.3V supply), each amplifier can drive two DC-coupled video loads to ground. If the supply is less than 3.135V, each amplifier can drive only one DC-coupled or AC-coupled video load.

Applications Information

AC-Coupling the Outputs

The outputs can be AC-coupled since the output stage can source and sink current as shown in Figure 3. Coupling capacitors should be 220μF or greater to keep the highpass filter, formed by the 150Ω equivalent resistance of the video transmission line, to a corner frequency of 4.8Hz or below. The frame rate of PAL systems is 25Hz, the frame rate of NTSC systems is 30Hz, and the frame rate of VGA is usually 60Hz or higher. The corner frequency should be well below the frame rate.

Pin Configuration

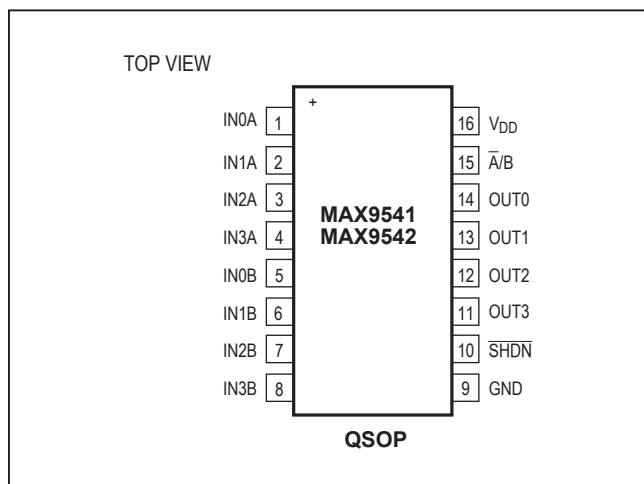

Power Consumption

The quiescent power consumption and average power consumption of the MAX9541/MAX9542 are very low because of 3.3V operation and low-power circuit design. Quiescent power consumption is defined when the MAX9541/MAX9542 are operating without loads and without any video signals.

Average power consumption represents the normal power consumption when the devices drive real video signals into real video loads. It is measured when the MAX9541/MAX9542 drive 150Ω loads to ground with a 50% flat field, which serves as proxy for a real video signal.

Table 4 shows the quiescent and average power consumption of the MAX9541/MAX9542.

Power-Supply Bypassing and Ground

The MAX9541/MAX9542 operate from a single-supply voltage down to 2.7V, allowing for low-power operation. Bypass V_{DD} to GND with a 0.1μF capacitor. Place all external components as close as possible to the device.

Chip Information

PROCESS: BiCMOS

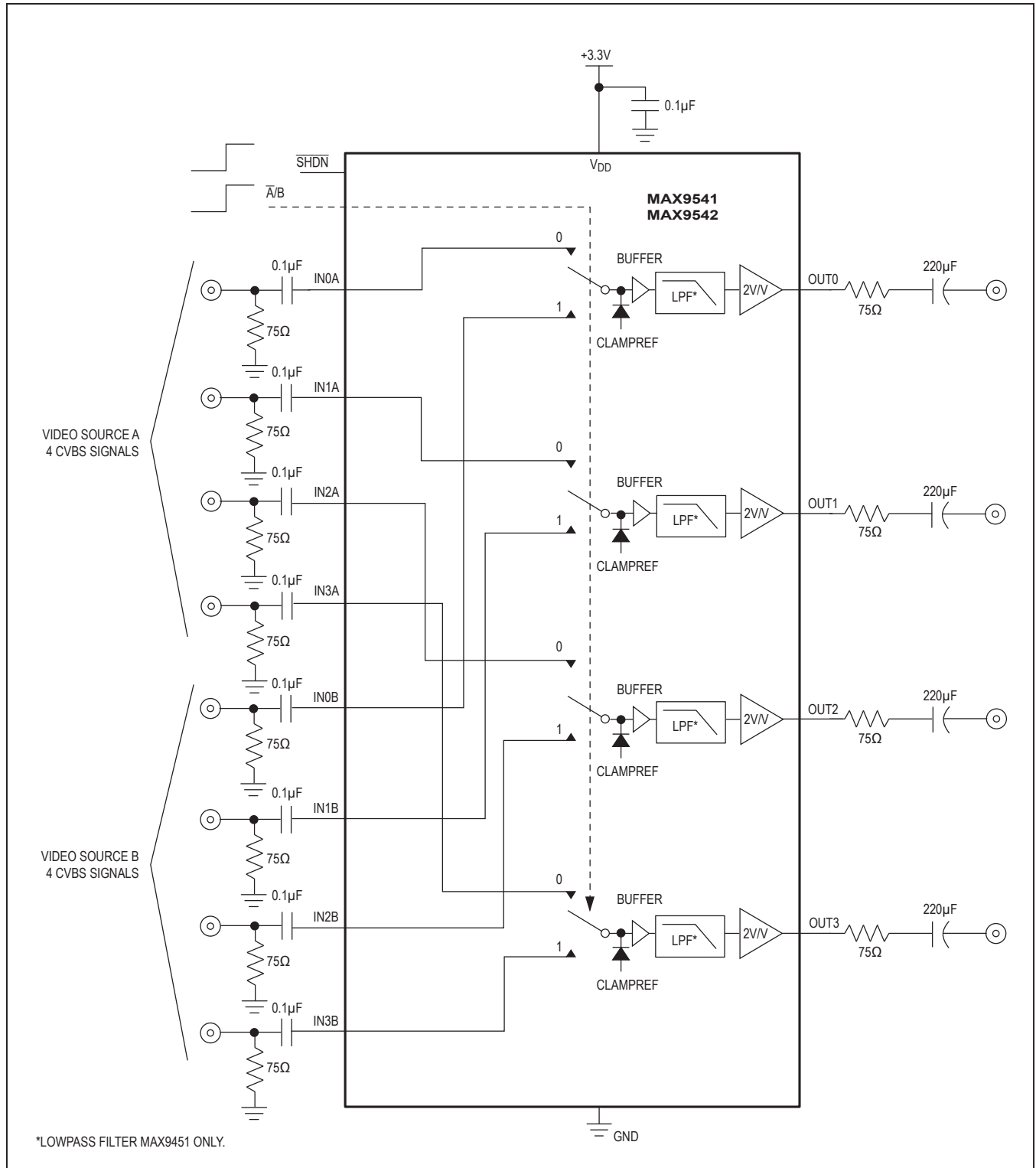
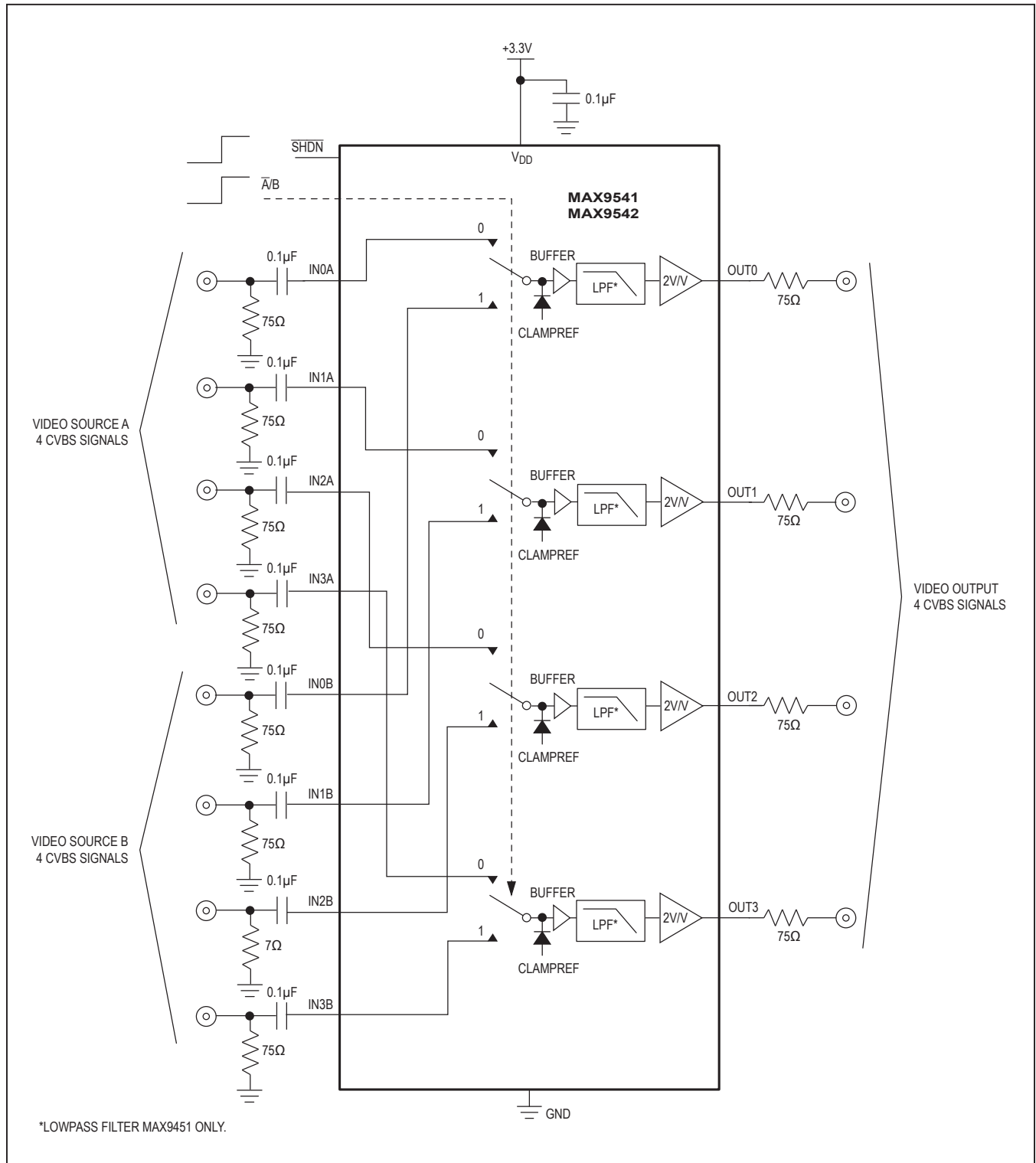

Figure 3. AC-Coupled Outputs

Typical Application Circuit



Package Information

For the latest package outline information and land patterns (footprints), go to www.maximintegrated.com/packages. Note that a "+", "#", or "-" in the package code indicates RoHS status only. Package drawings may show a different suffix character, but the drawing pertains to the package regardless of RoHS status.

PACKAGE TYPE	PACKAGE CODE	DOCUMENT NO.
16 QSOP	E16-4	21-0055

DIM	INCHES		MILLIMETERS	
	MIN	MAX	MIN	MAX
A	.053	.069	1.35	1.75
A1	.004	.010	.102	.254
A2	.049	.065	1.245	1.651
B	.008	.012	0.20	0.30
C	.0075	.0098	0.191	0.249
D	SEE VARIATIONS			
E	.150	.157	3.81	3.99
e	.025 BSC		0.635 BSC	
H	.230	.244	5.84	6.20
h	.010	.016	0.25	0.41
L	.016	.035	0.41	0.89
N	SEE VARIATIONS			
α	0°	8°	0°	8°

VARIATIONS:

	INCHES		MILLIMETERS		N	PKG CODES
	MIN.	MAX.	MIN.	MAX.		
D	.189	.196	4.80	4.98	16	E16-1, E16M-1, E16-4, E16-5, E16-8F
S	.0020	.0070	0.05	0.18		
D	.337	.344	8.56	8.74	20	E20-1, E20-2, E20-3
S	.0500	.0550	1.270	1.397		
D	.337	.344	8.56	8.74	24	E24-1, E24-2, E24-3
S	.0250	.0300	0.635	0.762		
D	.386	.393	9.80	9.98	28	E28-1, E28M-1, E28-2
S	.0250	.0300	0.635	0.762		

NOTES:

1. D & E DO NOT INCLUDE MOLD FLASH OR PROTRUSIONS.
2. MOLD FLASH OR PROTRUSIONS NOT TO EXCEED .006" PER SIDE.
3. CONTROLLING DIMENSIONS: INCHES.
4. MEETS JEDEC MO137.
5. MARKING SHOWN IS FOR PKG. ORIENTATION ONLY.
6. ALL DIMENSIONS APPLY TO BOTH LEADED (-) AND PbFREE (+) PKG. CODES.

TITLE:
PACKAGE OUTLINE
QSOP .150", .025" LEAD PITCH

APPROVAL	DOCUMENT CONTROL NO. 21-0055	REV. J
		1/1

-DRAWING NOT TO SCALE-

Revision History

REVISION NUMBER	REVISION DATE	DESCRIPTION	PAGES CHANGED
0	2/09	Initial release	—
1	9/14	Updated <i>Applications</i> section	1

For pricing, delivery, and ordering information, please contact Maxim Direct at 1-888-629-4642, or visit Maxim Integrated's website at www.maximintegrated.com.

Maxim Integrated cannot assume responsibility for use of any circuitry other than circuitry entirely embodied in a Maxim Integrated product. No circuit patent licenses are implied. Maxim Integrated reserves the right to change the circuitry and specifications without notice at any time. The parametric values (min and max limits) shown in the Electrical Characteristics table are guaranteed. Other parametric values quoted in this data sheet are provided for guidance.