



# 1.2W, Low-EMI, Filterless, Class D Audio Amplifier

MAX9746

## General Description

The MAX9746 mono Class D audio power amplifier provides Class AB amplifier performance with Class D efficiency, conserving board space and extending battery life. The MAX9746 is designed specifically for systems using 1.8V logic interface. Using a Class D architecture, the MAX9746 delivers 1.2W into an 8Ω load while offering efficiencies near 90%. A low-EMI modulation scheme renders the traditional Class D output filter unnecessary.

The MAX9746 offers two modulation schemes: a fixed-frequency (FFM) mode, and a spread-spectrum (SSM) mode that reduces EMI-radiated emissions due to the modulation frequency. Furthermore, the MAX9746 oscillator can be synchronized to an external clock through the SYNC input, allowing the switching frequency to be user defined. The SYNC input also allows multiple MAX9746s to be cascaded and frequency locked, minimizing interference due to clock intermodulation. The device utilizes a fully differential architecture, a full-bridged output, and comprehensive click-and-pop suppression. The gain of the MAX9746 is set internally further reducing external component count.

The MAX9746 features high 72dB PSRR, a low 0.1% THD+N, and SNR in excess of 90dB. Short-circuit and thermal-overload protection prevent the device from damage during a fault condition. The MAX9746 is available in a 12-bump UCSP™ (1.5mm × 2mm × 0.6mm) package. The MAX9746 is specified over the extended -40°C to +85°C temperature range.

## Applications

Cellular Phones  
PDAs

MP3 Players  
Portable Audio

## Block Diagram

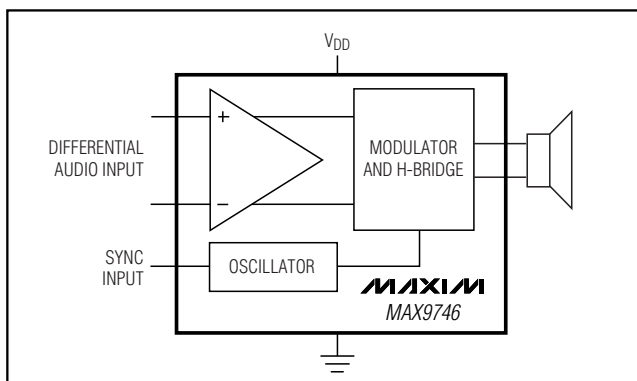

UCSP is a trademark of Maxim Integrated Products, Inc.

## Features

- ◆ Filterless Amplifier Passes FCC Radiated Emissions Standards with 100mm of Cable
- ◆ Unique Spread-Spectrum Mode Offers 5dB Emissions Improvement Over Conventional Methods
- ◆ Optional External SYNC Input
- ◆ Simple Master-Slave Setup for Stereo Operation
- ◆ 88% Efficiency
- ◆ 1.2W into 8Ω
- ◆ Low 0.1% THD+N
- ◆ High PSRR (72dB at 217Hz)
- ◆ Integrated Click-and-Pop Suppression
- ◆ 1.8V Logic-Compatible
- ◆ Low Quiescent Current (4mA)
- ◆ Low-Power Shutdown Mode (0.1μA)
- ◆ Short-Circuit and Thermal-Overload Protection
- ◆ Available in Thermally Efficient, Space-Saving 12-Bump UCSP Package (1.5mm x 2mm x 0.6mm)

## Ordering Information

| PART          | TEMP RANGE     | PIN-PACKAGE |
|---------------|----------------|-------------|
| MAX9746BEBC+T | -40°C to +85°C | 12 UCSP-12  |

+Denotes lead-free package.

## Pin Configuration

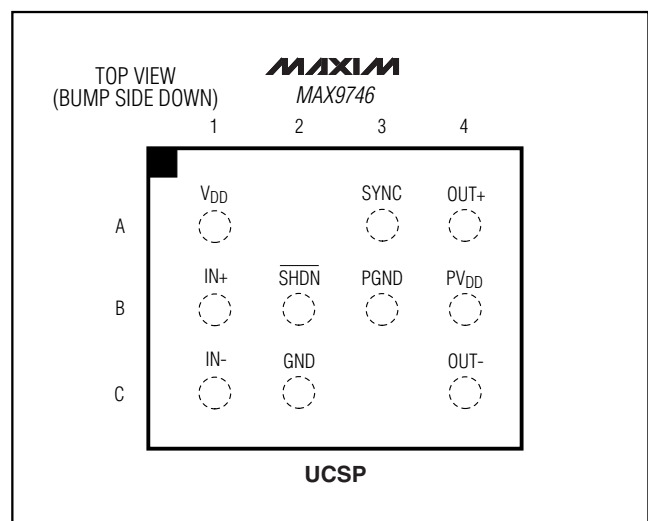

# 1.2W, Low-EMI, Filterless, Class D Audio Amplifier

## ABSOLUTE MAXIMUM RATINGS

V<sub>DD</sub> to GND .....6V  
 PV<sub>DD</sub> to PGND .....6V  
 GND to PGND .....-0.3V to +0.3V  
 All Other Pins to GND.....-0.3V to (V<sub>DD</sub> + 0.3V)  
 Continuous Current Into/Out of PV<sub>DD</sub>/PGND/OUT\_.....±600mA  
 Continuous Input Current (all other pins).....±20mA  
 Duration of OUT\_ Short Circuit to GND or PV<sub>DD</sub>.....Continuous  
 Duration of Short Circuit Between OUT+ and OUT- ..Continuous

Continuous Power Dissipation (T<sub>A</sub> = +70°C)  
 12-Bump UCSP (derate 6.1mW/°C above +70°C).....484mW  
 Junction Temperature .....+150°C  
 Operating Temperature Range .....-40°C to +85°C  
 Storage Temperature Range .....-65°C to +150°C  
 Lead Temperature (soldering, 10s) .....+300°C  
 Bump Temperature (soldering)  
 Reflow .....+235°C

Stresses beyond those listed under "Absolute Maximum Ratings" may cause permanent damage to the device. These are stress ratings only, and functional operation of the device at these or any other conditions beyond those indicated in the operational sections of the specifications is not implied. Exposure to absolute maximum rating conditions for extended periods may affect device reliability.

## ELECTRICAL CHARACTERISTICS

(V<sub>DD</sub> = PV<sub>DD</sub> = SHDN = 3.3V, GND = PGND = 0V, SYNC = GND (FFM), R<sub>L</sub> = 8Ω, R<sub>L</sub> connected between OUT+ and OUT-, T<sub>A</sub> = T<sub>MIN</sub> to T<sub>MAX</sub>, unless otherwise noted. Typical values are at T<sub>A</sub> = +25°C.) (Notes 1, 2)

| PARAMETER                             | SYMBOL            | CONDITIONS  | MIN                         | TYP  | MAX  | UNITS |  |
|---------------------------------------|-------------------|---|-----------------------------|------|------|-------|--|
| <b>GENERAL</b>                        |                   |   |                             |      |      |       |  |
| Supply Voltage Range                  | V <sub>DD</sub>   | Inferred from PSRR test   | 2.5                         |      | 5.5  | V     |  |
| Quiescent Current                     | I <sub>DD</sub>   |   |                             | 4    | 5.2  | mA    |  |
| Shutdown Current                      | I <sub>SHDN</sub> |   |                             | 0.1  | 10   | μA    |  |
| Turn-On Time                          | t <sub>ON</sub>   |   |                             | 30   |      | ms    |  |
| Input Resistance                      | R <sub>IN</sub>   | T <sub>A</sub> = +25°C  | 12                          | 20   |      | kΩ    |  |
| Input Bias Voltage                    | V <sub>BIAS</sub> | Either input  | 0.73                        | 0.83 | 0.93 | V     |  |
| Voltage Gain                          | A <sub>V</sub>    |   |                             | 12   |      | dB    |  |
| Output Offset Voltage                 | V <sub>OS</sub>   | T <sub>A</sub> = +25°C  |                             | ±11  | ±80  | mV    |  |
|                                       |                   | T <sub>MIN</sub> ≤ T <sub>A</sub> ≤ T <sub>MAX</sub>  |                             |      | ±120 |       |  |
| Common-Mode Rejection Ratio           | CMRR              | f <sub>IN</sub> = 1kHz, input referred  |                             | 72   |      | dB    |  |
| Power-Supply Rejection Ratio (Note 3) | PSRR              | V <sub>DD</sub> = 2.5V to 5.5V, T <sub>A</sub> = +25°C  | 50                          | 70   |      | dB    |  |
|                                       |                   | 200mV <sub>P-P</sub> ripple   | f <sub>RIPPLE</sub> = 217Hz |      | 72   |       |  |
|                                       |                   |   | f <sub>RIPPLE</sub> = 20kHz |      | 55   |       |  |
| Output Power                          | P <sub>OUT</sub>  | THD+N = 1%<br>R <sub>L</sub> = 8Ω   |                             | 530  |      | mW    |  |
| Total Harmonic Distortion Plus Noise  | THD+N             | f <sub>IN</sub> = 1kHz, either FFM or SSM<br>R <sub>L</sub> = 8Ω,<br>P <sub>OUT</sub> = 125mW |                             | 0.1  |      | %     |  |
| Signal-to-Noise Ratio                 | SNR               | V <sub>OUT</sub> = 2V <sub>RMS</sub>  | BW = 22Hz to 22kHz          | FFM  | 89   | dB    |  |
|                                       |                   |   |                             | SSM  | 87   |       |  |
|                                       |                   |   | A-weighted                  | FFM  | 92   |       |  |
|                                       |                   |   |                             | SSM  | 90   |       |  |
| Oscillator Frequency                  | f <sub>OSC</sub>  | SYNC = GND  | 980                         | 1100 | 1220 | kHz   |  |
|                                       |                   | SYNC = float  | 1280                        | 1450 | 1620 |       |  |
|                                       |                   | SYNC = V <sub>DD</sub> (SSM mode)   |                             | 1220 | ±120 |       |  |

# 1.2W, Low-EMI, Filterless, Class D Audio Amplifier

MAX9746

## ELECTRICAL CHARACTERISTICS (continued)

( $V_{DD} = PV_{DD} = \overline{SHDN} = 3.3V$ ,  $GND = PGND = 0V$ ,  $SYNC = GND$  (FFM),  $R_L = 8\Omega$ ,  $R_L$  connected between  $OUT+$  and  $OUT-$ ,  $T_A = T_{MIN}$  to  $T_{MAX}$ , unless otherwise noted. Typical values are at  $T_A = +25^\circ C$ .) (Notes 1, 2)

| PARAMETER                               | SYMBOL | CONDITIONS                          |                   | MIN | TYP             | MAX     | UNITS   |
|---|--------|-------------------------------------|-------------------|-----|-----------------|---------|---------|
| SYNC Frequency Lock Range               |        |                                     |                   | 800 |                 | 2000    | kHz     |
| Efficiency                              | $\eta$ | $P_{OUT} = 500mW$ , $f_{IN} = 1kHz$ |                   |     | 94              |         | %       |
| <b>DIGITAL INPUTS (SHDN, SYNC)</b>      |        |                                     |                   |     |                 |         |         |
| $\overline{SHDN}$ Input Threshold       |        | $V_{IH}$                            |                   | 1.4 |                 | 0.4     | V       |
|   |        | $V_{IL}$                            |                   |     |                 |         |         |
| $\overline{SHDN}$ Input Leakage Current |        |                                     |                   |     |                 | $\pm 1$ | $\mu A$ |
| SYNC Input Threshold                    |        | External clock                      | $V_{IH}$          | 1.4 |                 | 0.4     | V       |
|   |        |                                     | $V_{IL}$          |     |                 |         |         |
|   |        | Internal clock                      | SSM mode          | 1.9 | Tie to $V_{DD}$ |         |         |
|   |        |                                     | FFM mode (1.1MHz) |     | Tie to GND      |         |         |
| FFM mode (1.45MHz)                      |        |                                     | Float             |     |                 |         |         |
| SYNC Input Current                      |        |                                     |                   |     |                 | $\pm 5$ | $\mu A$ |

## ELECTRICAL CHARACTERISTICS

( $V_{DD} = PV_{DD} = \overline{SHDN} = 5V$ ,  $GND = PGND = 0V$ ,  $SYNC = GND$  (FFM),  $R_L = 8\Omega$ ,  $R_L$  connected between  $OUT+$  and  $OUT-$ ,  $T_A = T_{MIN}$  to  $T_{MAX}$ , unless otherwise noted. Typical values are at  $T_A = +25^\circ C$ .) (Notes 1, 2)

| PARAMETER                            | SYMBOL     | CONDITIONS                     |                                     | MIN | TYP  | MAX  | UNITS   |
|--------------------------------------|------------|--------------------------------|-------------------------------------|-----|------|------|---------|
| Quiescent Current                    | $I_{DD}$   |                                |                                     |     | 5.2  |      | mA      |
| Shutdown Current                     | $I_{SHDN}$ |                                |                                     |     | 0.1  |      | $\mu A$ |
| Common-Mode Rejection Ratio          | CMRR       | $f = 1kHz$ , input referred    |                                     |     | 72   |      | dB      |
| Power-Supply Rejection Ratio         | PSRR       | 200mV <sub>P-P</sub> ripple    | $f = 217Hz$                         |     | 72   |      | dB      |
|                                      |            |                                | $f = 20kHz$                         |     | 55   |      |         |
| Output Power                         | $P_{OUT}$  | THD+N = 1%                     | $R_L = 8\Omega$                     |     | 1200 |      | mW      |
| Total Harmonic Distortion Plus Noise | THD+N      | $f = 1kHz$ , either FFM or SSM | $R_L = 8\Omega$ , $P_{OUT} = 125mW$ |     | 0.1  |      | %       |
| Signal-to-Noise Ratio                | SNR        | $V_{OUT} = 3V_{RMS}$           | BW = 22Hz to 22kHz                  | FFM |      | 92.5 | dB      |
|                                      |            |                                |                                     | SSM |      | 90.5 |         |
|                                      |            |                                | A-weighted                          | FFM |      | 95.5 |         |
|                                      |            |                                |                                     | SSM |      | 93.5 |         |

**Note 1:** All devices are 100% production tested at  $+25^\circ C$ . All temperature limits are guaranteed by design.

**Note 2:** Testing performed with a resistive load in series with an inductor to simulate an actual speaker load. For  $R_L = 8\Omega$ ,  $L = 68\mu H$ .

**Note 3:** PSRR is specified with the amplifier inputs connected to GND through  $C_{IN}$ .

# 1.2W, Low-EMI, Filterless, Class D Audio Amplifier

## Typical Operating Characteristics

( $V_{DD} = 3.3V$ ,  $SYNC = V_{DD}$  (SSM),  $T_A = +25^\circ C$ , unless otherwise noted.)

**TOTAL HARMONIC DISTORTION PLUS NOISE vs. FREQUENCY**

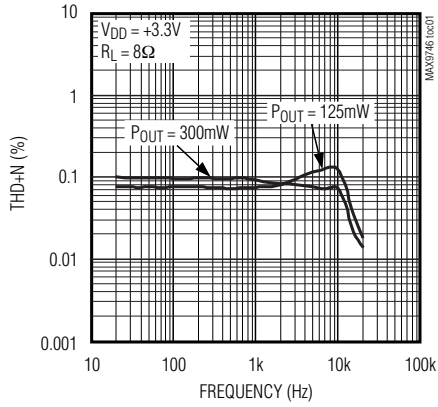

**TOTAL HARMONIC DISTORTION PLUS NOISE vs. FREQUENCY**

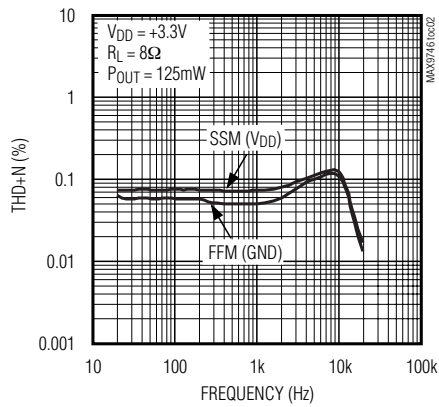

**TOTAL HARMONIC DISTORTION PLUS NOISE vs. OUTPUT POWER**

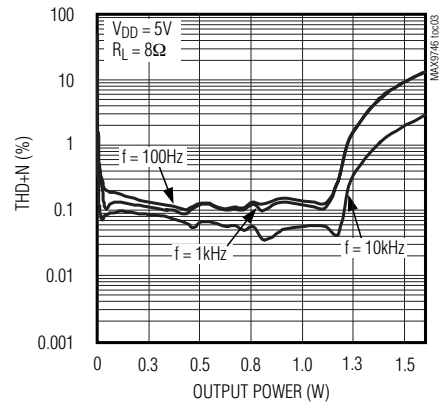

**TOTAL HARMONIC DISTORTION PLUS NOISE vs. OUTPUT POWER**

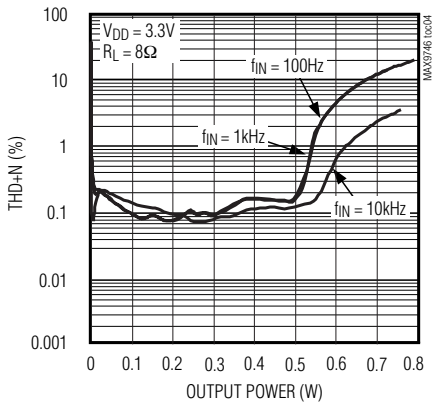

**TOTAL HARMONIC DISTORTION PLUS NOISE vs. OUTPUT POWER**

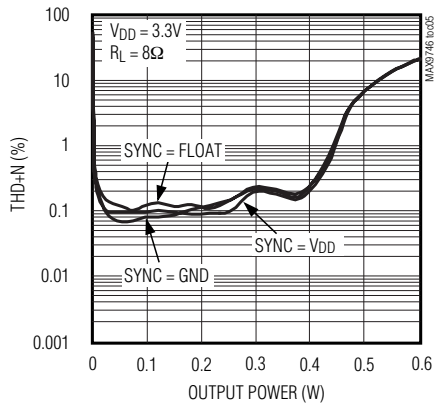

**TOTAL HARMONIC DISTORTION PLUS NOISE vs. OUTPUT POWER**

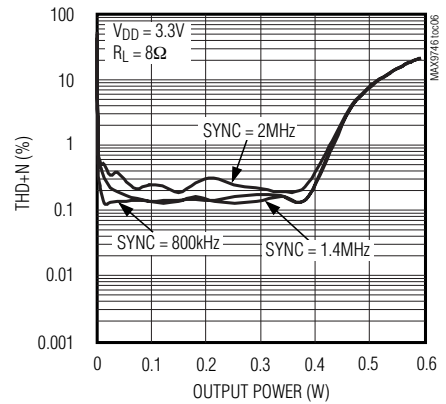

**TOTAL HARMONIC DISTORTION PLUS NOISE vs. COMMON-MODE VOLTAGE**

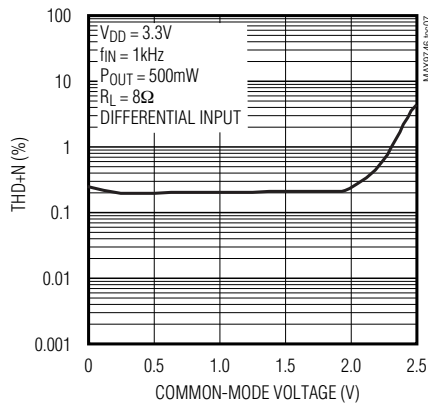

**EFFICIENCY vs. OUTPUT POWER**

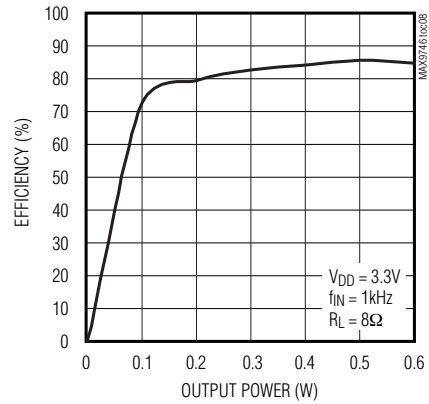

# 1.2W, Low-EMI, Filterless, Class D Audio Amplifier

MAX9746

## Typical Operating Characteristics (continued)

( $V_{DD} = 3.3V$ , SYNC =  $V_{DD}$  (SSM),  $T_A = +25^\circ C$ , unless otherwise noted.)

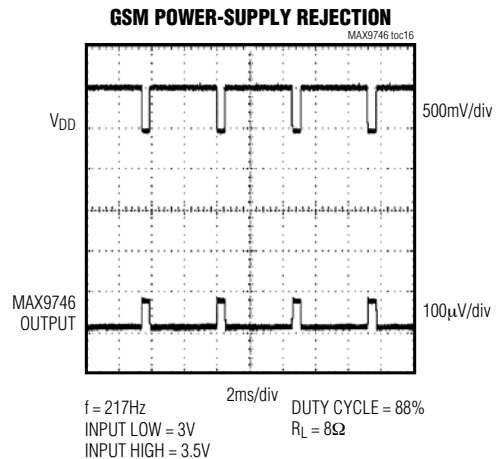
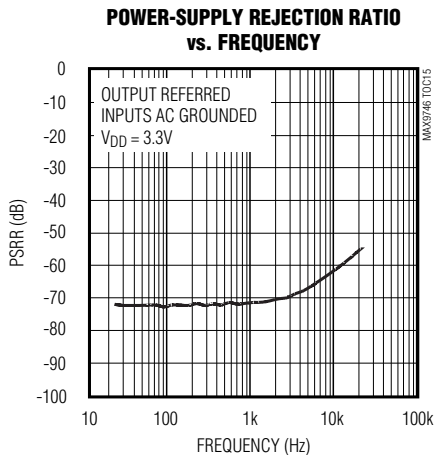
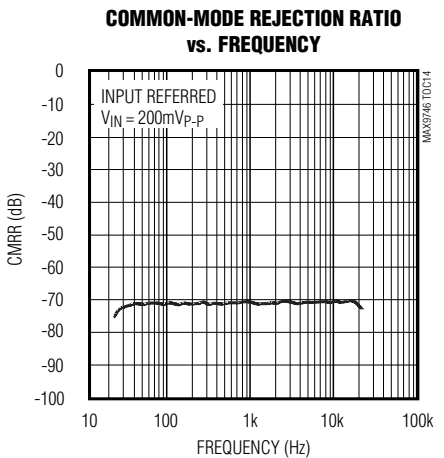
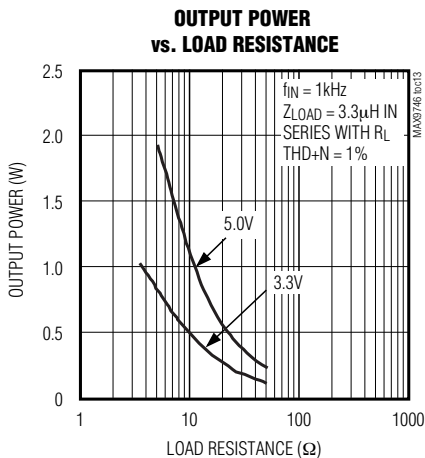
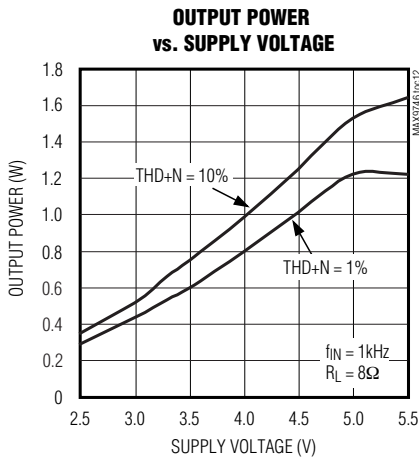
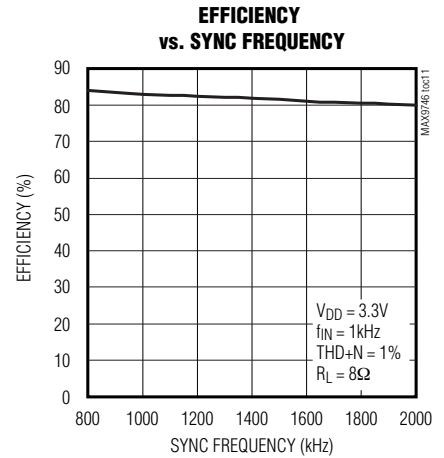
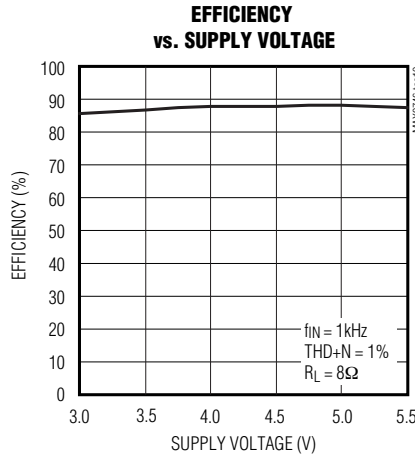
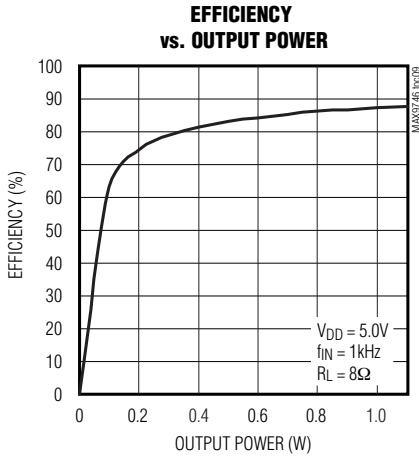

# 1.2W, Low-EMI, Filterless, Class D Audio Amplifier

## Typical Operating Characteristics (continued)

( $V_{DD} = 3.3V$ ,  $SYNC = V_{DD}$  (SSM),  $T_A = +25^\circ C$ , unless otherwise noted.)

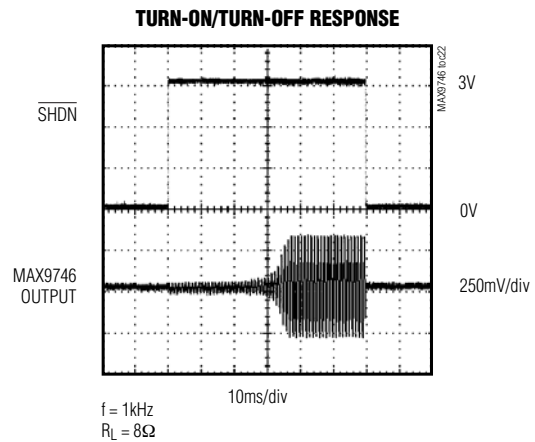
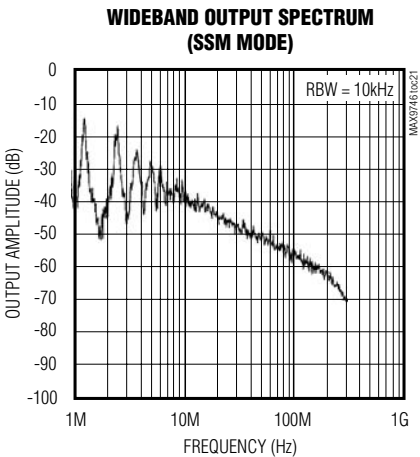
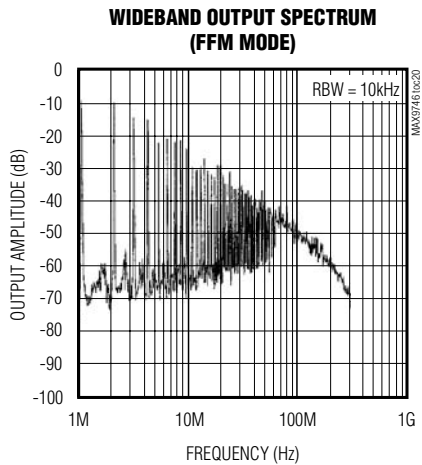
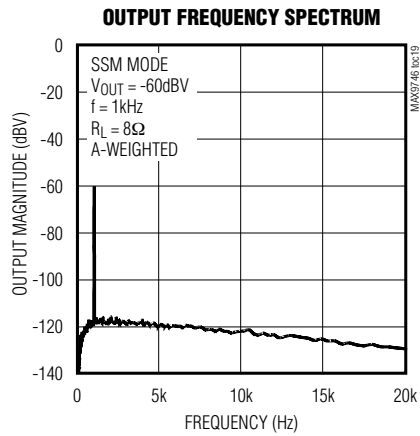
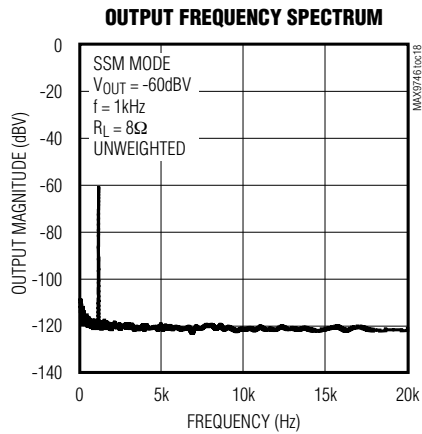
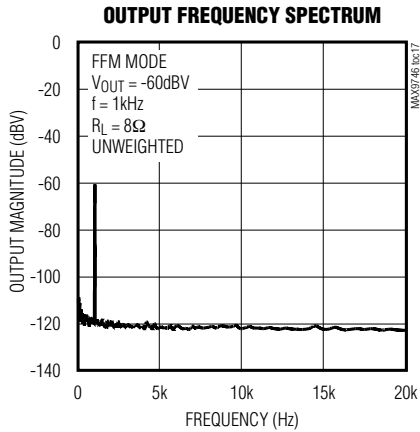

# 1.2W, Low-EMI, Filterless, Class D Audio Amplifier

MAX9746

## Typical Operating Characteristics (continued)

( $V_{DD} = 3.3V$ ,  $SYNC = V_{DD}$  (SSM),  $T_A = +25^\circ C$ , unless otherwise noted.)

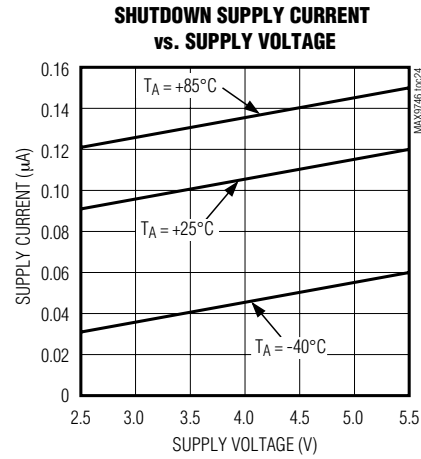
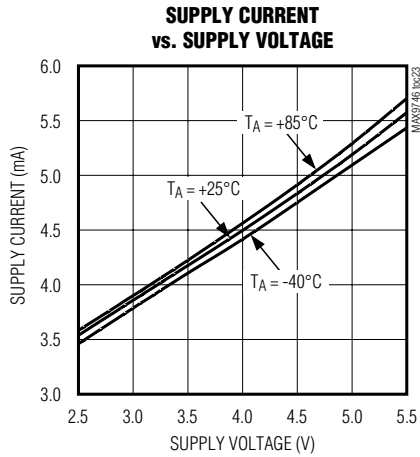

## Functional Diagram

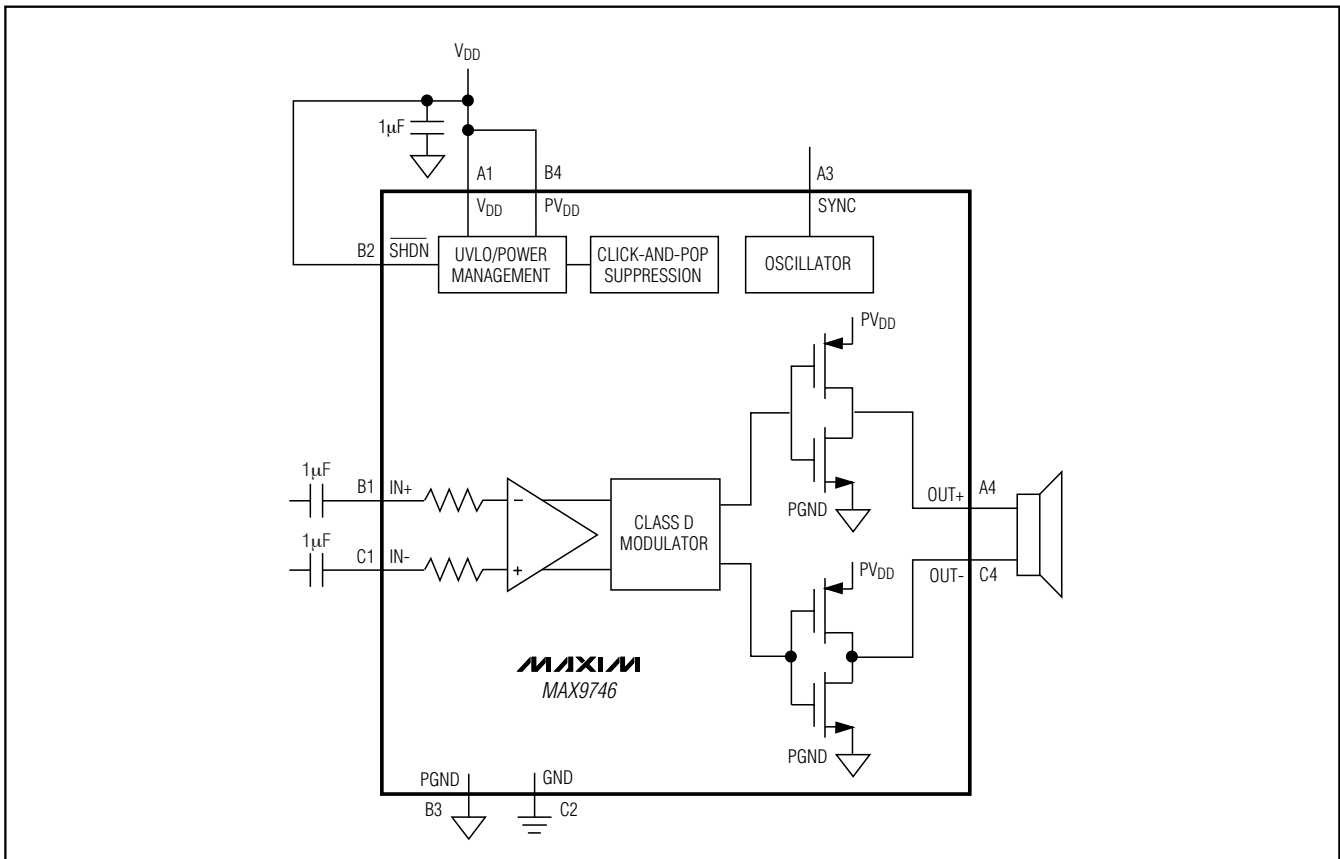

# 1.2W, Low-EMI, Filterless, Class D Audio Amplifier

## Pin Description

| BUMP | NAME                     | FUNCTION   |
|------|--------------------------|--|
| A1   | V <sub>DD</sub>          | Analog Power Supply  |
| B1   | IN+                      | Noninverting Audio Input   |
| C1   | IN-                      | Inverting Audio Input  |
| C2   | GND                      | Analog Ground  |
| B2   | $\overline{\text{SHDN}}$ | Active-Low Shutdown Input. Connect to V <sub>DD</sub> for normal operation.  |
| A3   | SYNC                     | Frequency Select and External Clock Input.<br><b>SYNC = GND:</b> Fixed-frequency mode with $f_S = 1100\text{kHz}$ .<br><b>SYNC = Float:</b> Fixed-frequency mode with $f_S = 1450\text{kHz}$ .<br><b>SYNC = V<sub>DD</sub>:</b> Spread-spectrum mode with $f_S = 1220\text{kHz} \pm 120\text{kHz}$ .<br><b>SYNC = Clocked:</b> Fixed-frequency mode with $f_S = \text{external clock frequency}$ . |
| B3   | PGND                     | Power Ground   |
| A4   | OUT+                     | Amplifier-Output Positive Phase  |
| C4   | OUT-                     | Amplifier-Output Negative Phase  |
| B4   | PV <sub>DD</sub>         | H-Bridge Power Supply  |

## Detailed Description

The MAX9746 filterless, Class D audio power amplifier features several improvements to switch-mode amplifier technology. The MAX9746 offers Class AB performance with Class D efficiency, while occupying minimal board space. A unique filterless modulation scheme, synchronizable switching frequency, and SSM mode create a compact, flexible, low-noise, efficient audio power amplifier. The differential input architecture reduces common-mode noise pickup, and can be used without input-coupling capacitors. The device can also be configured as a single-ended input amplifier.

Comparators monitor the MAX9746 inputs and compare the complementary input voltages to the sawtooth waveform. The comparators trip when the input magnitude of the sawtooth exceeds their corresponding input voltage. Both comparators reset at a fixed time after the rising edge of the second comparator trip point, generating a minimum-width pulse  $t_{ON(MIN)}$  at the output of the second comparator (Figure 1). As the input voltage increases or decreases, the duration of the pulse at one output increases (the first comparator to trip) while the other output pulse duration remains at  $t_{ON(MIN)}$ . This causes the net voltage across the speaker ( $V_{OUT+} - V_{OUT-}$ ) to change.

### Operating Modes

#### Fixed-Frequency Modulation (FFM) Mode

The MAX9746 features two FFM modes. The FFM modes are selected by setting SYNC = GND for a 1.1MHz

switching frequency, and SYNC = FLOAT for a 1.45MHz switching frequency. In FFM mode, the frequency spectrum of the Class D output consists of the fundamental switching frequency and its associated harmonics (see the Wideband Output Spectrum graph in the *Typical Operating Characteristics*). The MAX9746 allows the switching frequency to be changed by +32%, should the frequency of one or more of the harmonics fall in a sensitive band. This can be done at any time and does not affect audio reproduction.

#### Spread-Spectrum Modulation (SSM) Mode

The MAX9746 features a unique spread-spectrum mode that flattens the wideband spectral components, improving EMI emissions that may be radiated by the speaker and cables by 5dB. Proprietary techniques ensure that the cycle-to-cycle variation of the switching period does not degrade audio reproduction or efficiency (see the *Typical Operating Characteristics*). Select SSM mode by setting SYNC = V<sub>DD</sub>. In SSM mode, the switching frequency varies randomly by  $\pm 120\text{kHz}$  around the center frequency (1.22MHz). The modulation scheme remains the same, but the period of the sawtooth waveform changes from cycle to cycle (Figure 2). Instead of a large amount of spectral energy present at multiples of the switching frequency, the energy is now spread over a bandwidth that increases with frequency. Above a few megahertz, the wideband spectrum looks like white noise for EMI purposes.



# 1.2W, Low-EMI, Filterless, Class D Audio Amplifier

MAX9746

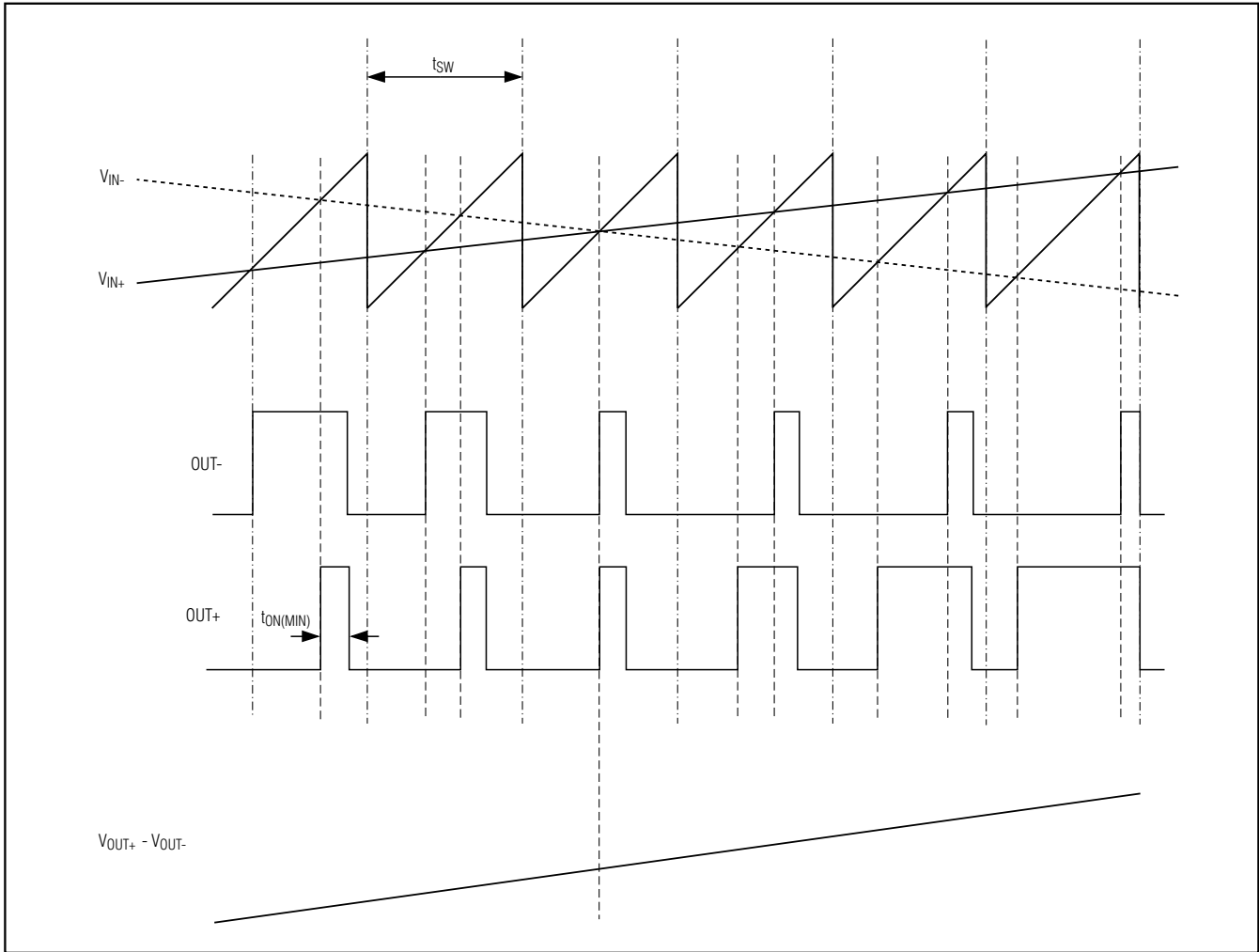

Figure 1. MAX9746 Outputs with an Input Signal Applied

Table 1. Operating Modes

| SYNC INPUT | MODE  |
|------------|---|
| GND        | FFM with $f_S = 1100\text{kHz}$                   |
| FLOAT      | FFM with $f_S = 1450\text{kHz}$                   |
| $V_{DD}$   | SSM with $f_S = 1220\text{kHz} \pm 120\text{kHz}$ |
| Clocked    | FFM with $f_S = \text{external clock frequency}$  |

### External Clock Mode

The SYNC input allows the MAX9746 to be synchronized to a system clock (allowing a fully synchronous system), or allocating the spectral components of the switching harmonics to insensitive frequency bands. Applying an external TTL clock of 800kHz to 2MHz to SYNC synchronizes the switching frequency of the MAX9746. The period of the SYNC clock can be randomized, enabling the MAX9746 to be synchronized to another MAX9746 operating in SSM mode.

# 1.2W, Low-EMI, Filterless, Class D Audio Amplifier

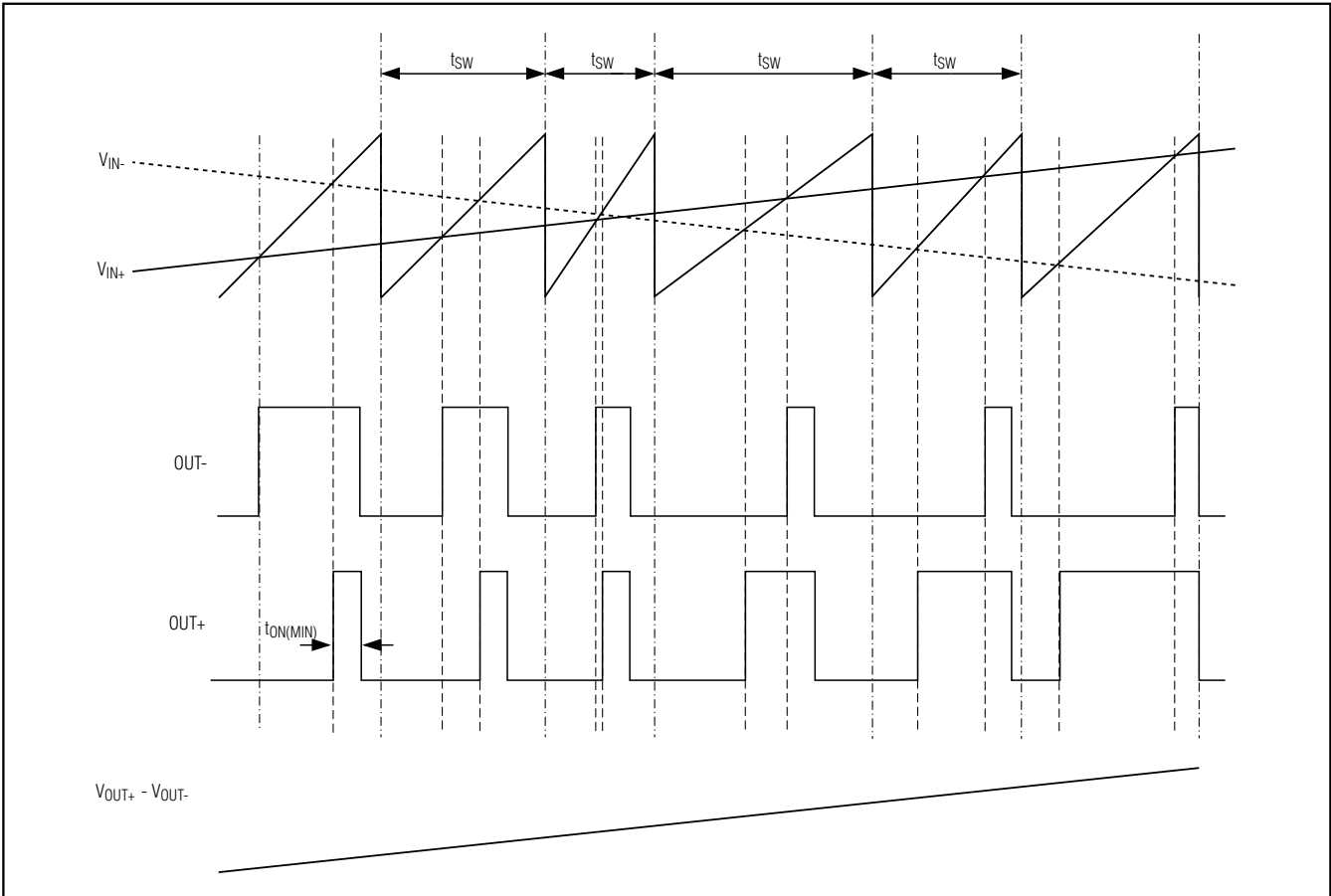

Figure 2. MAX9746 Output with an Input Signal Applied (SSM Mode)

### Filterless Modulation/Common-Mode Idle

The MAX9746 uses Maxim’s unique modulation scheme that eliminates the LC filter required by traditional Class D amplifiers, improving efficiency, reducing component count, and conserving board space and system cost. Conventional Class D amplifiers output a 50% duty-cycle square wave when no signal is present. With no filter, the square wave appears across the load as a DC voltage, resulting in finite load current, increasing power consumption. When no signal is present at the input of the MAX9746, the outputs switch as shown in Figure 3. Because the MAX9746 drives the speaker differentially, the two outputs cancel each other, resulting in no net idle mode voltage across the speaker, minimizing power consumption.

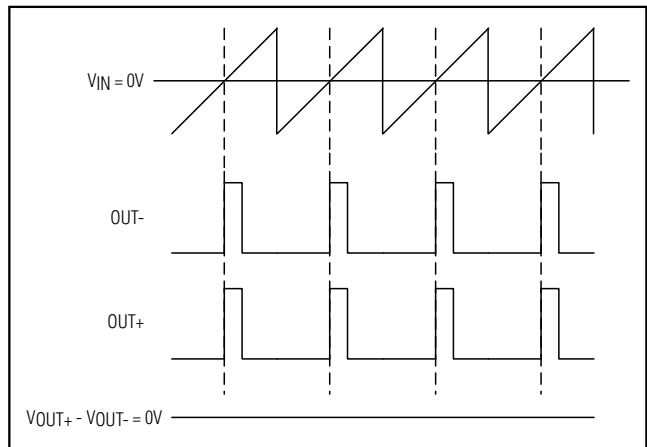

Figure 3. MAX9746 Outputs with No Input Signal

# 1.2W, Low-EMI, Filterless, Class D Audio Amplifier

## Efficiency

Efficiency of a Class D amplifier is attributed to the region of operation of the output stage transistors. In a Class D amplifier, the output transistors act as current-steering switches and consume negligible additional power. Any power loss associated with the Class D output stage is mostly due to the  $I \times R$  loss of the MOSFET on-resistance, and quiescent current overhead.

The theoretical best efficiency of a linear amplifier is 78%; however, that efficiency is only exhibited at peak output powers. Under normal operating levels (typical music reproduction levels), efficiency falls below 30%, whereas the MAX9746 still exhibits near 90% efficiencies under the same conditions (Figure 4).

## Shutdown

The MAX9746 has a shutdown mode that reduces power consumption and extends battery life. Driving  $\overline{\text{SHDN}}$  low places the MAX9746 in a low-power (0.1 $\mu\text{A}$ ) shutdown mode. Connect  $\overline{\text{SHDN}}$  to  $V_{\text{DD}}$  for normal operation.

## Click-and-Pop Suppression

The MAX9746 features comprehensive click-and-pop suppression that eliminates audible transients on startup and shutdown. While in shutdown, the H-bridge is in a high-impedance state. During startup or power-up, the input amplifiers are muted and an internal loop sets the modulator bias voltages to the correct levels, preventing clicks and pops when the H-bridge is subsequently enabled. For 35ms following startup, a soft-start function gradually unmutes the input amplifiers.

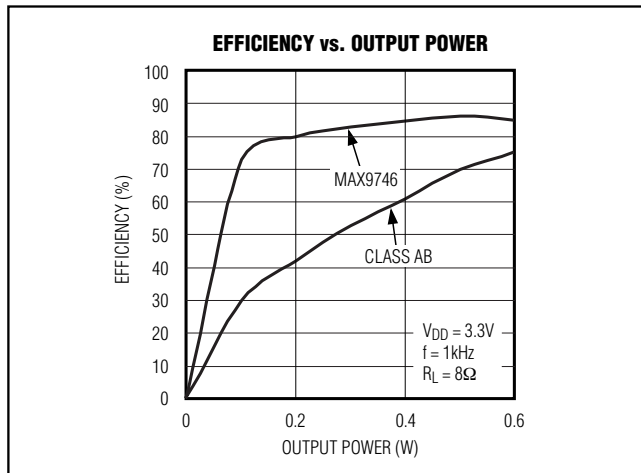

Figure 4. MAX9746 Efficiency vs. Class AB Efficiency

## Applications Information

### Filterless Operation

Traditional Class D amplifiers require an output filter to recover the audio signal from the amplifier's output. The filters add cost, increase the solution size of the amplifier, and can decrease efficiency. The traditional PWM scheme uses large differential output swings ( $2 \times V_{\text{DD}}$  peak-to-peak) and causes large ripple currents. Any parasitic resistance in the filter components results in a loss of power, lowering the efficiency.

The MAX9746 does not require an output filter. The device relies on the inherent inductance of the speaker coil and the natural filtering of both the speaker and the human ear to recover the audio component of the square-wave output. Eliminating the output filter results in a smaller, less costly, more efficient solution.

Because the frequency of the MAX9746 output is well beyond the bandwidth of most speakers, voice coil movement due to the square-wave frequency is very small. Although this movement is small, a speaker not designed to handle the additional power can be damaged. For optimum results, use a speaker with a series inductance  $>10\mu\text{H}$ . Typical  $8\Omega$  speakers exhibit series inductances in the  $20\mu\text{H}$  to  $100\mu\text{H}$  range.

### Power-Conversion Efficiency

Unlike a Class AB amplifier, the output offset voltage of a Class D amplifier does not noticeably increase quiescent current draw when a load is applied. This is due to the power conversion of the Class D amplifier. For example, an 8mV DC offset across an  $8\Omega$  load results in 1mA extra current consumption in a Class AB device. In the Class D case, an 8mV offset into  $8\Omega$  equates to an additional power drain of  $8\mu\text{W}$ . Due to the high efficiency of the Class D amplifier, this represents an additional quiescent-current draw of  $8\mu\text{W}/(V_{\text{DD}}/100\eta)$ , which is in the order of a few microamps.

### Input Amplifier

#### Differential Input

The MAX9746 features a differential input structure, making it compatible with many CODECs, and offering improved noise immunity over a single-ended input amplifier. In devices such as cellular phones, high-frequency signals from the RF transmitter can be picked up by the amplifier's input traces. The signals appear at the amplifier's inputs as common-mode noise. A differential input amplifier amplifies the difference of the two inputs; any signal common to both inputs is canceled.

# 1.2W, Low-EMI, Filterless, Class D Audio Amplifier

## Single-Ended Input

The MAX9746 can be configured as a single-ended input amplifier by capacitively coupling either input to GND and driving the other input (Figure 5).

## DC-Coupled Input

The input amplifier can accept DC-coupled inputs that are biased within the amplifier's common-mode range (see the *Typical Operating Characteristics*). DC coupling eliminates the input-coupling capacitors, reducing component count to potentially one external component (see the *System Diagram*). However, the low-frequency rejection of the capacitors is lost, allowing low-frequency signals to feedthrough to the load.

## Component Selection

### Input Filter

An input capacitor,  $C_{IN}$ , in conjunction with the input impedance of the MAX9746 forms a highpass filter that removes the DC bias from an incoming signal. The AC-coupling capacitor allows the amplifier to bias the signal to an optimum DC level. Assuming zero source impedance, the -3dB point of the highpass filter is given by:

$$f_{-3dB} = \frac{1}{2\pi R_{IN} C_{IN}}$$

Choose  $C_{IN}$  so  $f_{-3dB}$  is well below the lowest frequency of interest. Setting  $f_{-3dB}$  too high affects the low-frequency response of the amplifier. Use capacitors whose dielectrics have low-voltage coefficients, such as tantalum or aluminum electrolytic. Capacitors with high-voltage coefficients, such as ceramics, may result in increased distortion at low frequencies.

Other considerations when designing the input filter include the constraints of the overall system and the actual frequency band of interest. Although high-fidelity audio calls for a flat gain response between 20Hz and 20kHz, portable voice-reproduction devices such as cellular phones and two-way radios need only concen-

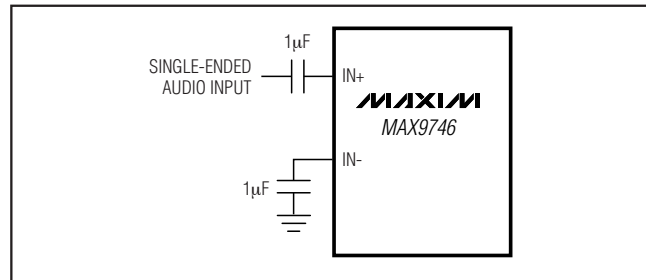

Figure 5. Single-Ended Input

trate on the frequency range of the spoken human voice (typically 300Hz to 3.5kHz). In addition, speakers used in portable devices typically have a poor response below 150Hz. Taking these two factors into consideration, the input filter may not need to be designed for a 20Hz to 20kHz response, saving both board space and cost due to the use of smaller capacitors.

### Output Filter

The MAX9746 does not require an output filter. The device passes FCC emissions standards with 100mm of unshielded speaker cables. However, output filtering can be used if a design is failing radiated emissions due to board layout or cable length, or the circuit is near EMI-sensitive devices. Use an LC filter when radiated emissions are a concern, or when long leads are used to connect the amplifier to the speaker.

### Supply Bypassing/Layout

Proper power-supply bypassing ensures low-distortion operation. For optimum performance, bypass  $V_{DD}$  to GND and  $PV_{DD}$  to PGND with separate 0.1µF capacitors as close to each pin as possible. A low-impedance, high-current power-supply connection to  $PV_{DD}$  is assumed. Additional bulk capacitance should be added as required depending on the application and power-supply characteristics. GND and PGND should be star connected to system ground. Refer to the MAX9746 evaluation kit for layout guidance.

# 1.2W, Low-EMI, Filterless, Class D Audio Amplifier

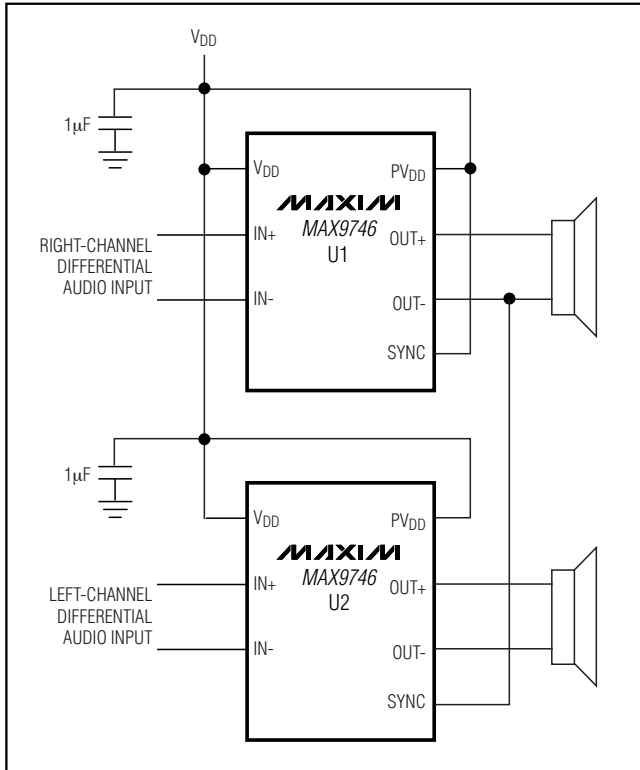

Figure 6. Master-Slave Stereo Configuration

## Stereo Configuration

Two MAX9746s can be configured as a stereo amplifier (Figure 6). Device U1 is the master amplifier; its unfiltered output drives the SYNC input of the slave device (U2), synchronizing the switching frequencies of the two devices. Synchronizing two MAX9746s ensures that no beat frequencies occur within the audio spectrum. This configuration works when the master device is in either FFM or SSM mode. There is excellent THD+N performance and minimal crosstalk between devices due to the SYNC connection (Figures 7 and 8). U2 locks onto only the frequency present at SYNC, not the pulse width. The internal feedback loop of device U2 ensures that the audio component of U1's output is rejected.

## Designing with Volume Control

The MAX9746 can easily be driven by single-ended sources (Figure 5), but extra care is needed if the source impedance "seen" by each differential input is unbalanced, such as the case in Figure 9, where the MAX9746 is used with an audio taper potentiometer acting as a volume control. Functionally, this configuration works well, but can suffer from click-pop transients at power-up (or coming out of shutdown) depending on the volume-control setting. As shown, the click-pop performance is fine for either max or min volume, but worsens at other settings.

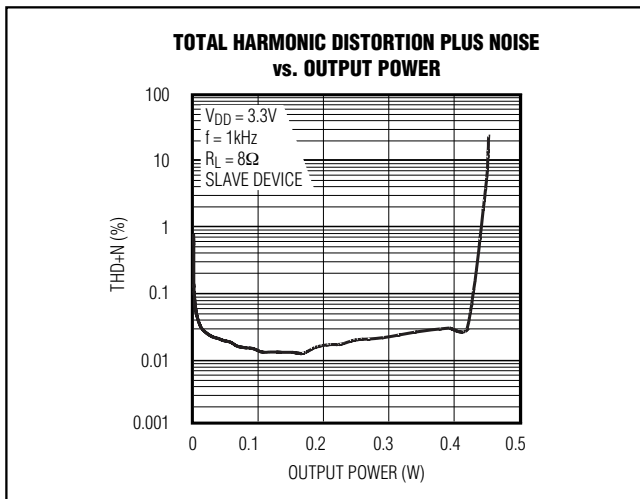

Figure 7. Master-Slave THD+N

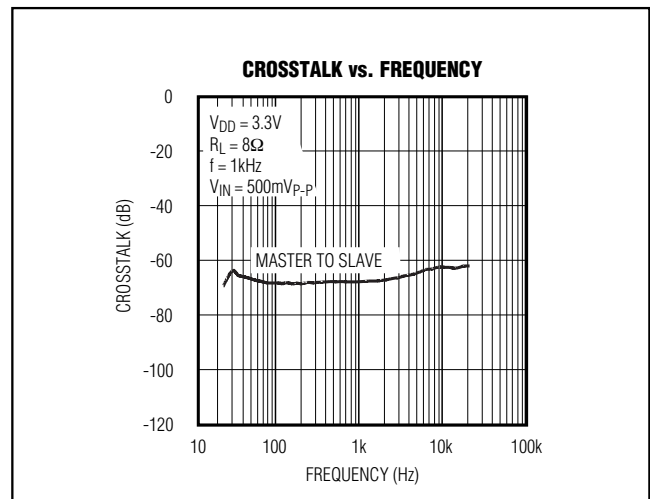

Figure 8. Master-Slave Crosstalk

# 1.2W, Low-EMI, Filterless, Class D Audio Amplifier

One solution is the configuration shown in Figure 9b. The potentiometer is connected between the differential inputs, and these “see” identical RC paths when the device powers up. The variable resistive element appears between the two inputs, meaning the setting affects both inputs the same way. The potentiometer is audio taper, as in Figure 9a. This significantly improves transient performance on power-up or release from shutdown. A similar approach can be applied when the MAX9746 is driven differentially and a volume control is required.

## UCSP Applications Information

For the latest application details on UCSP construction, dimensions, tape carrier information, PC board techniques, bump-pad layout, and recommended reflow temperature profile, as well as the latest information on reliability testing results, refer to the Application Note: *UCSP—A Wafer-Level Chip-Scale Package* available on Maxim’s website at [www.maxim-ic.com/ucsp](http://www.maxim-ic.com/ucsp).

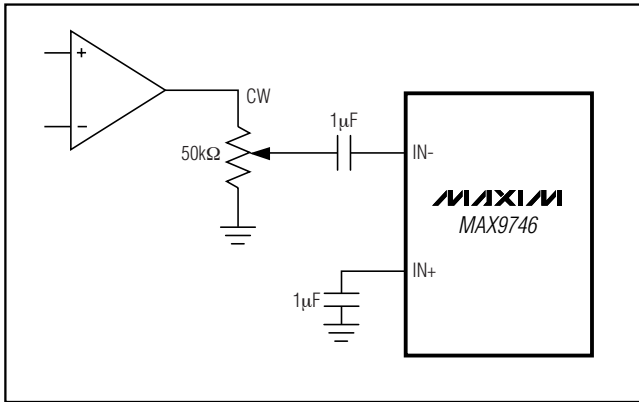

Figure 9a. Single-Ended Drive of MAX9746 Plus Volume

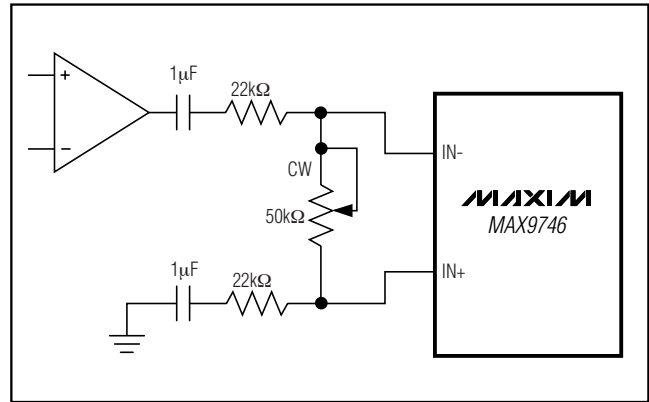
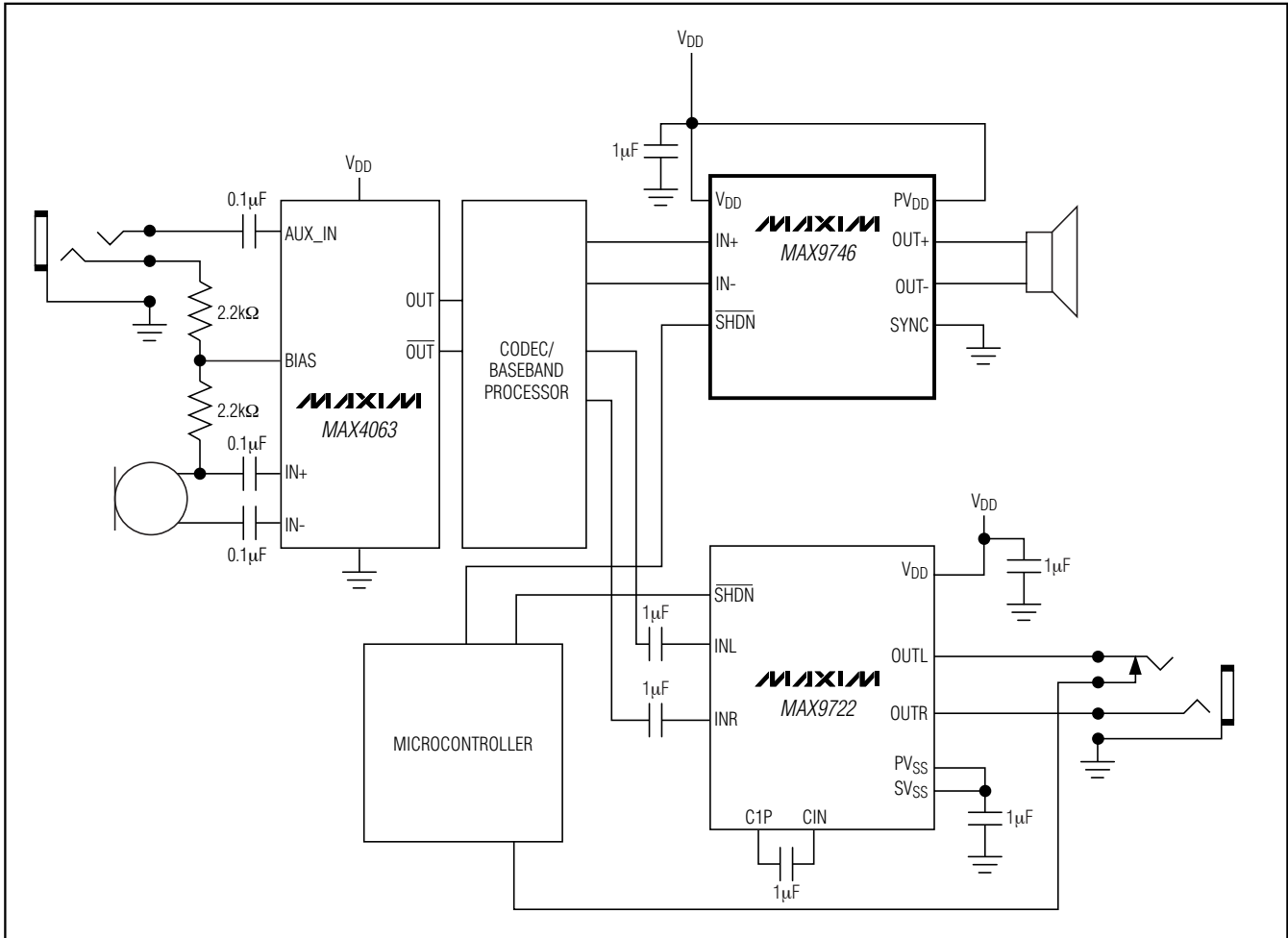

Figure 9b. Improved Single-Ended Drive of MAX9746 Plus Volume

# 1.2W, Low-EMI, Filterless, Class D Audio Amplifier

## System Diagram

**MAX9746**



### Chip Information

TRANSISTOR COUNT: 3595

PROCESS: BiCMOS

# 1.2W, Low-EMI, Filterless, Class D Audio Amplifier

## Package Information

(The package drawing(s) in this data sheet may not reflect the most current specifications. For the latest package outline information go to [www.maxim-ic.com/packages](http://www.maxim-ic.com/packages).)

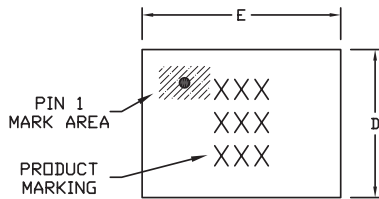

TOP VIEW

| COMMON DIMENSIONS |                |
|-------------------|----------------|
| A                 | 0.62±0.05-0.08 |
| A1                | 0.29±0.02      |
| A2                | 0.33 REF.      |
| b                 | ∅0.35±0.03     |
| D1                | 1.00 BASIC     |
| E1                | 1.50 BASIC     |
| e                 | 0.50 BASIC     |
| SD                | 0.00 BASIC     |
| SE                | 0.25 BASIC     |

| PKG. CODE | VARIABLE DIMENSIONS |           | DEPOPULATED SOLDER BALLS |
|-----------|---------------------|-----------|--------------------------|
|           | D                   | E         |                          |
| B12-1     | 1.54±0.05           | 2.02±0.05 | NONE                     |
| B12-2     | 1.54±0.05           | 2.02±0.05 | B3                       |
| B12-3     | 1.54±0.05           | 2.12±0.05 | NONE                     |
| B12-4     | 1.54±0.05           | 2.02±0.05 | B2, B3                   |
| B12-5     | 1.64±0.05           | 2.12±0.05 | B2                       |
| B12-6     | 1.64±0.05           | 2.12±0.05 | B3                       |
| B12-7     | 1.54±0.05           | 2.02±0.05 | B1, B3                   |
| B12-8     | 1.54±0.05           | 2.02±0.05 | B2                       |
| B12-9     | 1.54±0.05           | 2.12±0.05 | B2, B3                   |
| B12-10    | 1.54±0.05           | 2.02±0.05 | B1, B2, B3, B4           |
| B12-11    | 1.54±0.05           | 2.02±0.05 | A2, C3                   |

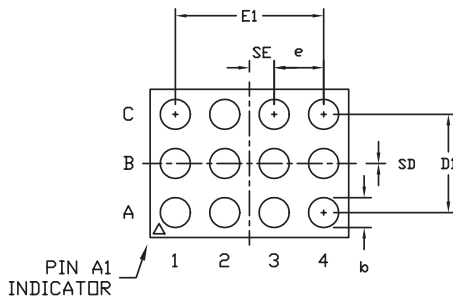

BOTTOM VIEW

- NOTES:  
 1. ALL DIMENSIONS ARE IN MILLIMETERS.  
 2. PRODUCT MARKING: NUMBER OF CHARACTERS AND LINES VARY PER PRODUCT.

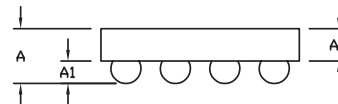

SIDE VIEW

|  |                                 |               |
|--|---------------------------------|---------------|
|  |                                 |               |
| PROPRIETARY INFORMATION<br>TITLE:<br>PACKAGE OUTLINE, 4x3 UCSP |                                 |               |
| APPROVAL   | DOCUMENT CONTROL NO.<br>21-0104 | REV.<br>F 1/1 |

12L, UCSP 4x3.EPS

Maxim cannot assume responsibility for use of any circuitry other than circuitry entirely embodied in a Maxim product. No circuit patent licenses are implied. Maxim reserves the right to change the circuitry and specifications without notice at any time.

16 \_\_\_\_\_ Maxim Integrated Products, 120 San Gabriel Drive, Sunnyvale, CA 94086 408-737-7600