

MAXQ3120 Evaluation Kit

Evaluates: MAXQ3120

General Description

The MAXQ3120 evaluation kit (EV kit) is a proven platform to conveniently evaluate the capabilities of the MAXQ3120 dual analog-to-digital converter (ADC) microcontroller. The kit contains the MAXQ3120 with the ADC inputs and spare GPIO pins brought out to headers, a JTAG programming interface, an on-board 3.3V power supply, and a 3.5 digit LCD. With the included serial-to-JTAG interface board, JTAG cable, and an RS-232 cable connected to a Windows®-compatible computer, the kit provides a completely functional system ideal for evaluating the MAXQ3120.

Evaluation Kit Contents

- ◆ MAXQ3120 Evaluation Kit Board with Processor and 8MHz Crystal Installed
- ◆ Serial-to-JTAG (MAXQJTAG) Interface Board, Serial Cable, and JTAG Cable
- ◆ MAXQ3120 Evaluation Kit CD
- ◆ Third-Party Compiler Tools Evaluation CD(s)

Ordering Information

PART	DESCRIPTION
MAXQ3120-KIT	MAXQ3120 EV Kit Board

Features

- ◆ Easily Loads Code Using Bootstrap Loader and Serial-to-JTAG Interface Board
- ◆ JTAG Interface Provides In-Application Debugging Features
 - Step-by-Step Execution Tracing
 - Breakpointing by Code Address, Data Memory Address, or Register Access
 - Data Memory View and Edit
- ◆ Static 3.5 Digit LCD Display Driven Directly by MAXQ3120
- ◆ On-Board 3.3V Power-Supply Regulator
- ◆ EV Kit Board can be Powered Directly Over JTAG Interface or from DC Power Supply
- ◆ Indicator LED Driven from Port Pin P0.6
- ◆ Pushbuttons for Reset, Three GPIO Inputs and One External Interrupt
- ◆ RS-232 Interface Included on Serial Port 1
- ◆ Included Full Board Schematics Provide a Convenient Reference Design

MAXQ is a trademark of Maxim Integrated Products, Inc. Windows is a registered trademark of Microsoft Corp.

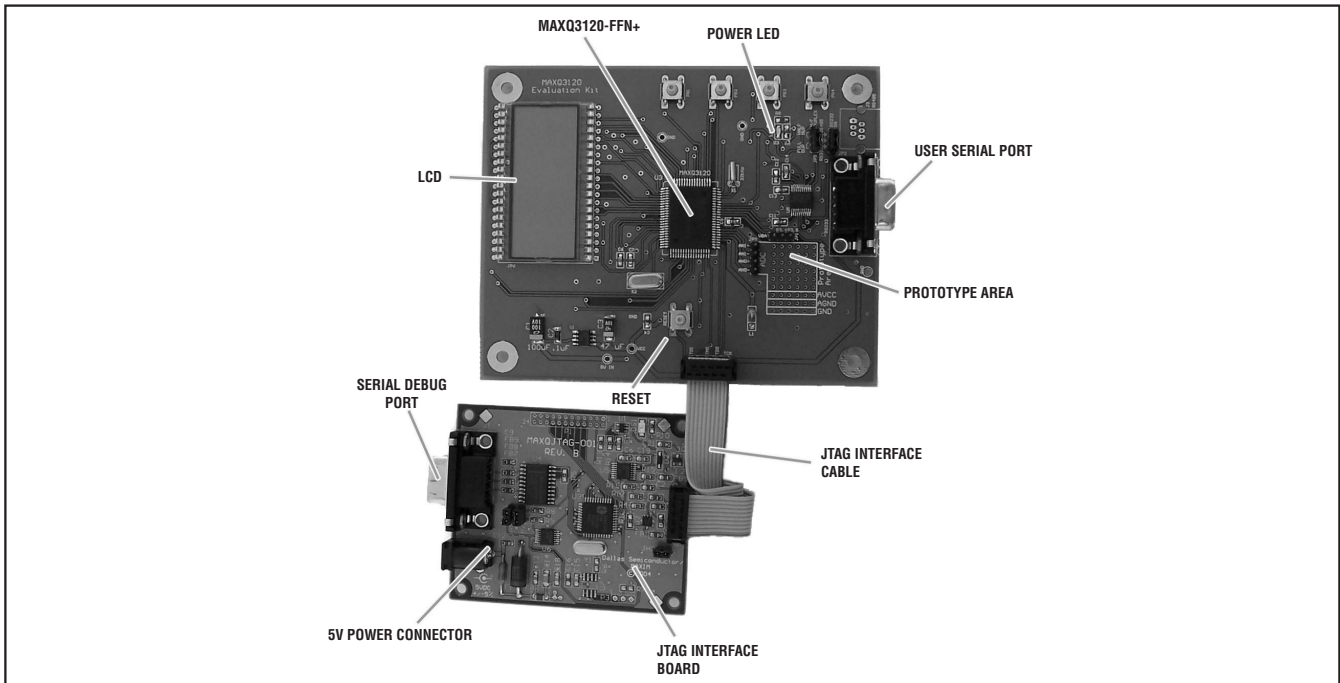

Figure 1. MAXQ3120 Evaluation Kit Setup

MAXQ3120 Evaluation Kit

Component List

DESIGNATION	QTY	DESCRIPTION	SUPPLIER/ PART NUMBER
C1	1	100µF tantalum capacitor	Nichicon F931A107MNC
C2	1	100nF tantalum capacitor	Nichicon F921V104MAA
C3	1	47µF tantalum capacitor	Nichicon F931A476MCC
C4, C5, C6, C7	4	1µF ceramic capacitors (0805)	Generic
C8–C18	11	100nF ceramic capacitors (0805)	Generic
C21	1	10nF ceramic capacitor (0805)	Generic
C22, C23	2	4.7µF capacitors (0805)	Generic
D3	1	Surface-mount red LED (0805)	Generic
J4	1	RS-232 DB9 female connector	AMP 747844-4
JP1	1	1 x 2 header, 0.1in spaced	3M 929834-02-02
JP2, JP5	2	1 x 3 headers, 0.1in spaced	3M 929834-02-03
JP3	1	2 x 5 header, 0.1in spaced	3M 929836-02-05
JP6	1	Static 3V–5V, 3-1/2 digit LCD	Lumex LCD-S3X1C50TR/A

DESIGNATION	QTY	DESCRIPTION	SUPPLIER/ PART NUMBER
JP9	1	1 x 4 header, 0.1in spaced	3M 929834-02-04
L1	1	56µH inductor	J.W. Miller 78F560J
R2–R7, R14, R15, R16	9	10kΩ ±5%, 1/8W resistors (0805)	Generic
R8	1	470Ω ±5%, 1/8W resistor (0805)	Generic
R10	1	0Ω shunt	—
R18	1	2.2Ω ±5%, 1/8W resistor (0805)	Generic
S1–S5	5	SPST N/O pushbutton	Omron B3W-1052BYOMZ
U1	1	MAX1658 350mA Linear regulator	Maxim MAX1658ESA
U3	1	MAXQ3120 Dual ADC microcontroller	Maxim MAXQ3120-FFN
U5	1	MAXQ3160 Multiprotocol transceiver	Maxim MAX3160CAP
X1	1	32.768kHz, 6pF crystal	Epson C-002RX 32.7680K-E
X2	1	8MHz crystal	Citizen HC49US8.000M ABJ

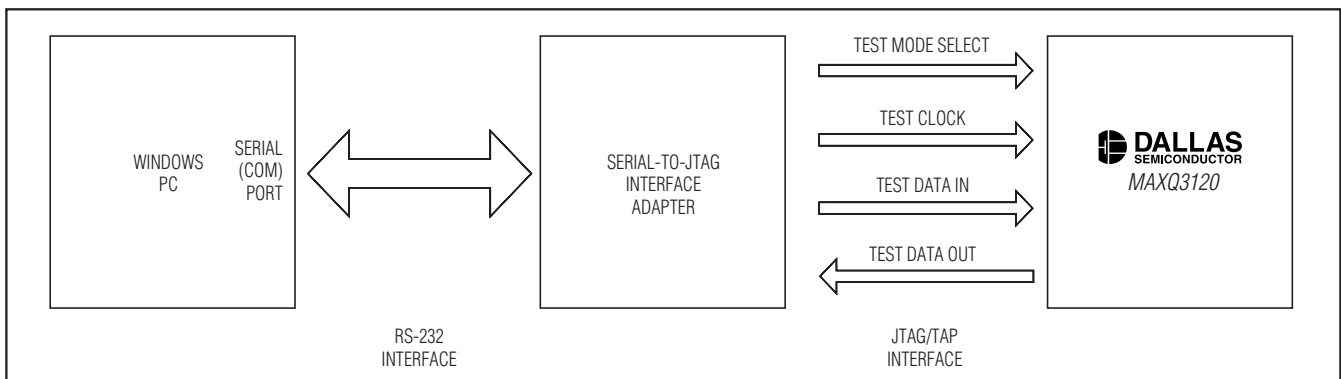

Figure 2. MAXQ3120 Serial-to-JTAG Interface

MAXQ3120 Evaluation Kit

Evaluates: MAXQ3120

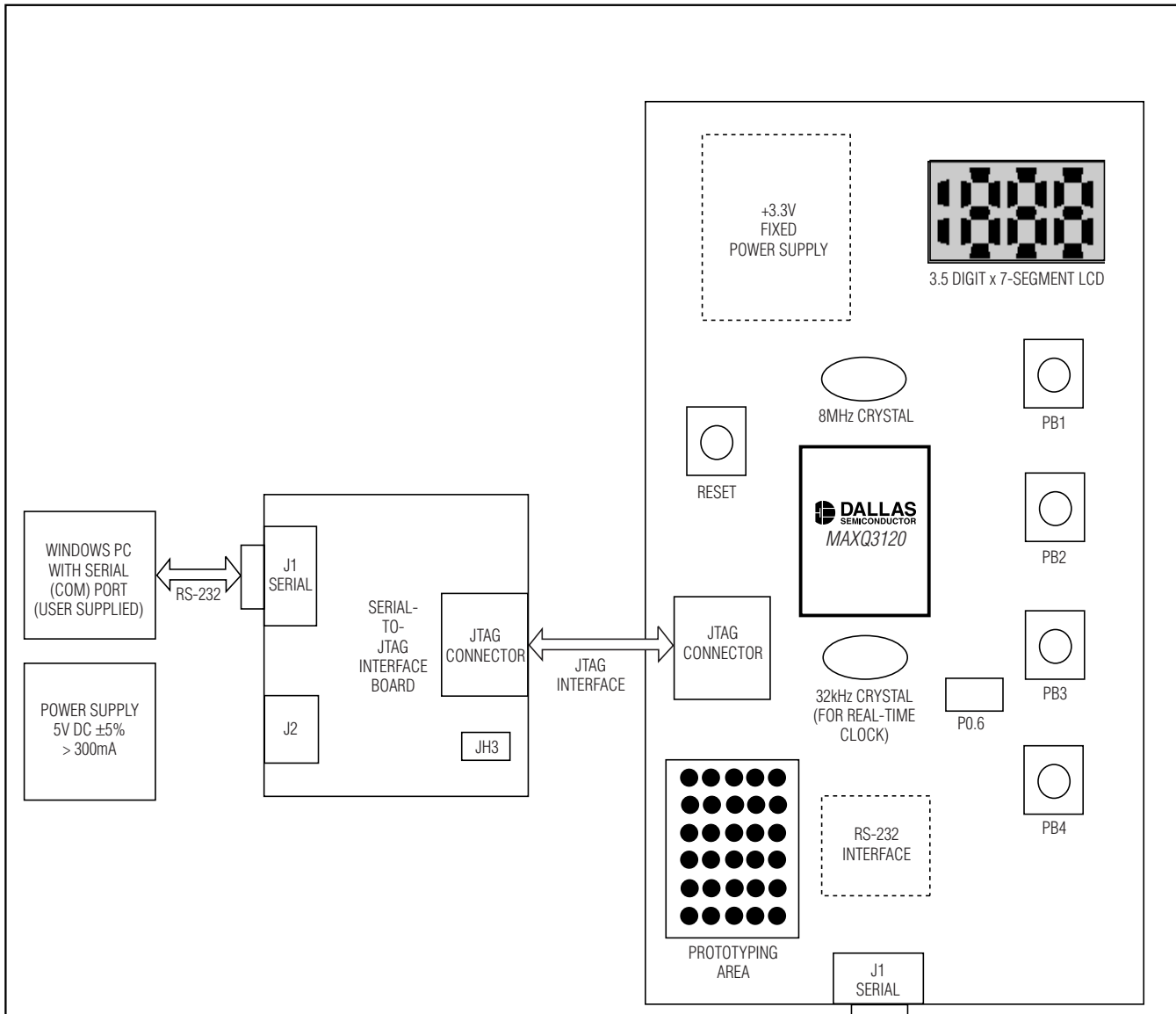

Figure 3. MAXQ3120 Evaluation Kit Functional Layout

Detailed Description

This EV kit must be used with the following documents:

- MAXQ3120 Data Sheet (www.maxim-ic.com/MAXQ3120)
- MAXQ Family User's Guide (www.maxim-ic.com/MAXQUG)
- MAXQ312x User's Guide Supplement (www.maxim-ic.com/MAXQ3120UG)

The MAXQ3120 EV kit board is fully defined in the included schematic. However, a short description of the major components and connectors of the boards follows.

Power Supplies

There are three ways to set up power supplies when using the MAXQ3120 EV kit. The two boards that require power supplies are the MAXQ3120 EV kit board and the serial-to-JTAG interface board.

MAXQ3120 Evaluation Kit

Running Both Boards from Separate Power Supplies

To run each of the boards from its own power supply, connect supplies as follows.

- Connect a 5V $\pm 5\%$ regulated DC wall supply to the J2 power plug of the serial-to-JTAG interface board.
- Connect a 3.3V regulated bench supply to test points VCC and GND on the MAXQ3120 EV kit board.

Note: When using two power supplies in this manner, the JP3 jumper on the serial-to-JTAG board must be DISCONNECTED.

Running Both Boards from a Single Power Supply

If the serial-to-JTAG interface board is being used, a single power supply can be used to power both boards as follows.

- Connect a 5V $\pm 5\%$ regulated DC wall supply to the J2 power plug of the serial-to-JTAG interface board.
- Connect the JH3 jumper on the serial-to-JTAG interface board.

Note: Do not connect a power supply to the test points on the MAXQ3120 EV kit when powering the boards in this manner.

Running the MAXQ3120 EV Kit Board from a Single Power Supply

If the MAXQ3120 has already been programmed using the JTAG interface, it is possible to disconnect the serial-to-JTAG board and power-up the MAXQ3120 EV kit board on its own. This simply executes the previously loaded firmware, with no possibility of in-application load or debugging.

- Connect a 3.3V regulated bench supply to test points VCC and GND on the MAXQ3120 EV kit board.

Internal Power Rail

If the MAXQ3120 EV kit is powered from the serial-to-JTAG board, it generates a 3.3V internal power rail from the 5V DC input power supply. This supply can be used to provide up to 100mA to circuitry on the prototyping area.

Using the LCD

The LCD included on the MAXQ3120 EV kit is a static (nonmultiplexed) 3V display with 3.5 digits of 7 segments each (Figure 4).

When the LCD controller is configured to static mode, the display's segments are memory mapped as noted in Table 1. (Refer to Table 29 in the MAXQ312x Supplement for more details.)

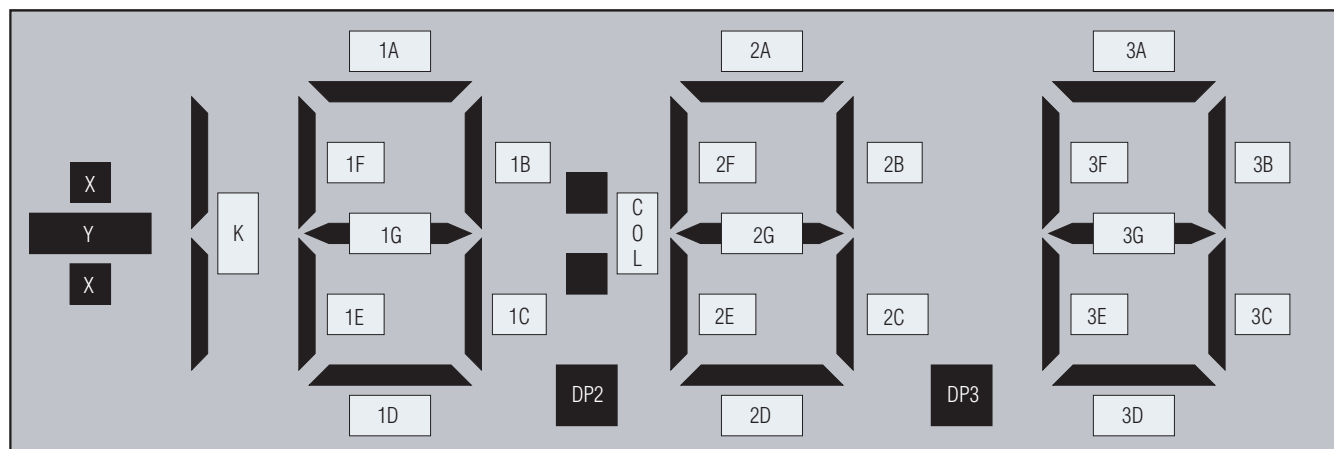

Figure 4. LCD Configuration

Table 1. LCD Memory Map (Static)

REGISTER	BIT 7	BIT 6	BIT 5	BIT 4	BIT 3	BIT 2	BIT 1	BIT 0
LCD0	2G	1G	1F	1E	1D	1C	1B	1A
LCD1	3A	DP2	2F	2E	2D	2C	2B	2A
LCD2	COL	DP3	3G	3F	3E	3D	3C	3B
LCD3						X	K	Y

MAXQ3120 Evaluation Kit

Evaluates: MAXQ3120

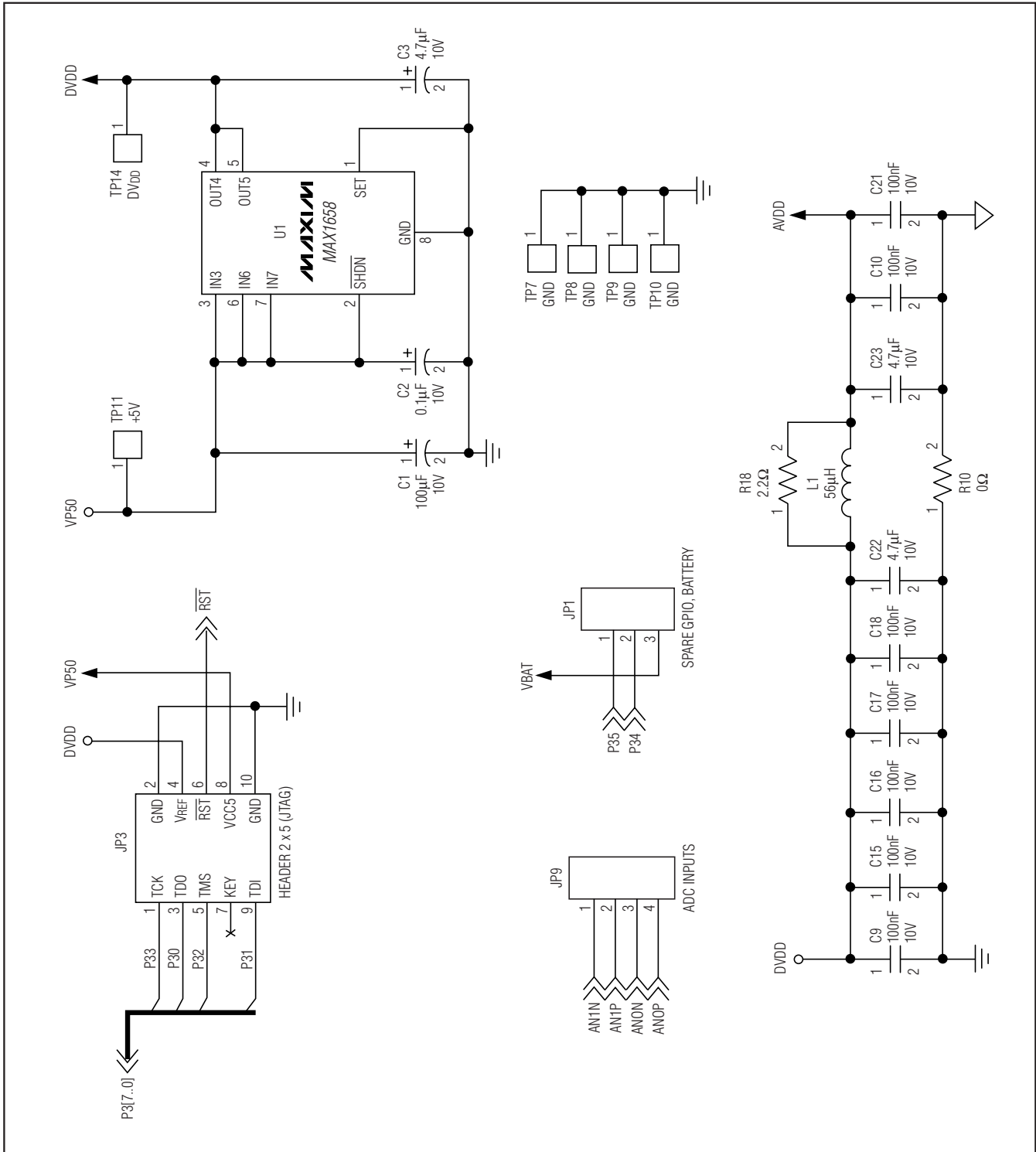

Figure 5. MAXQ3120 Evaluation Kit Power Schematics—Power, Headers (Sheet 1 of 4)

MAXQ3120 Evaluation Kit

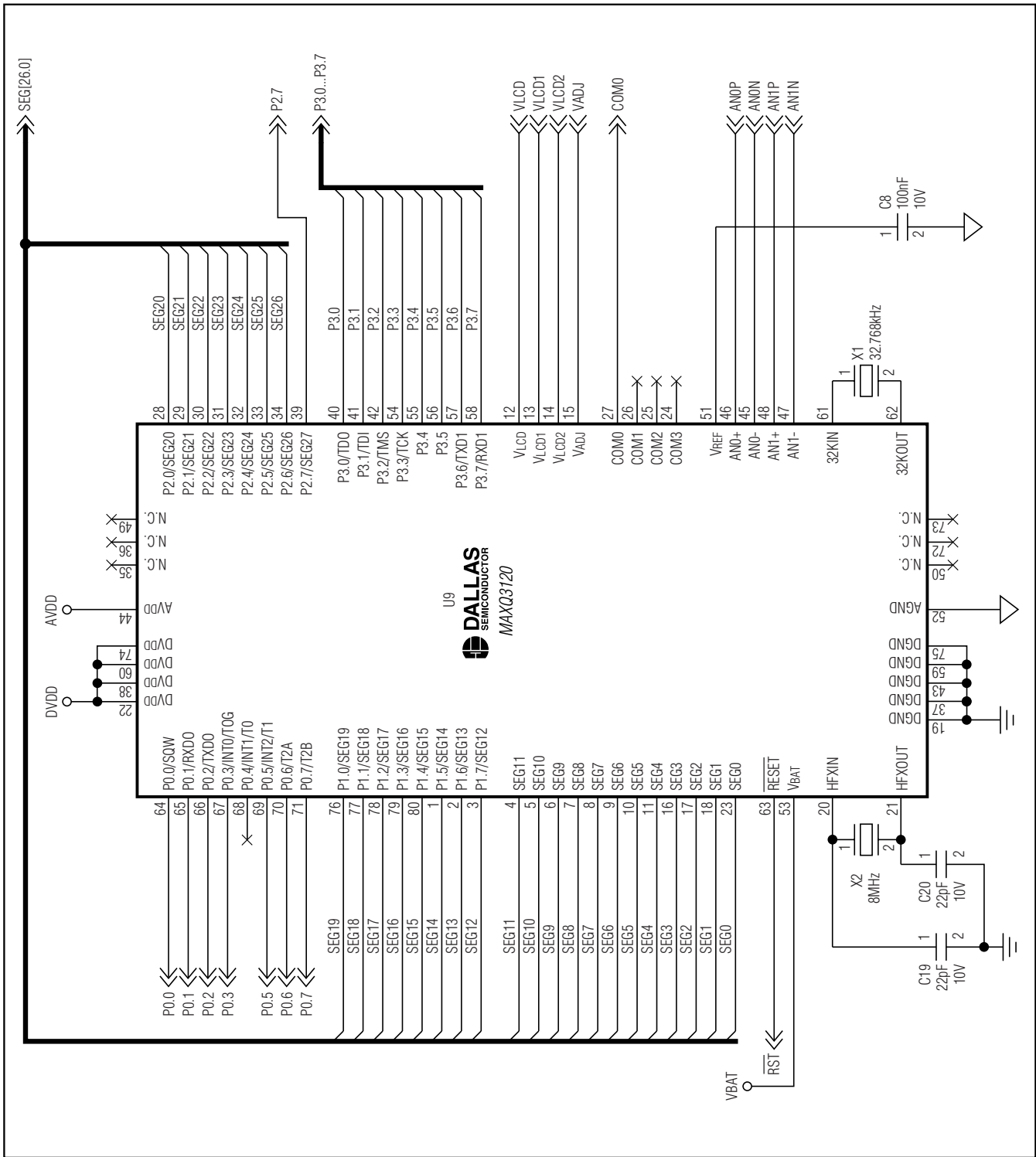

Figure 6. MAXQ3120 Evaluation Kit Power Schematics—Processor (Sheet 2 of 4)

MAXQ3120 Evaluation Kit

Evaluates: MAXQ3120

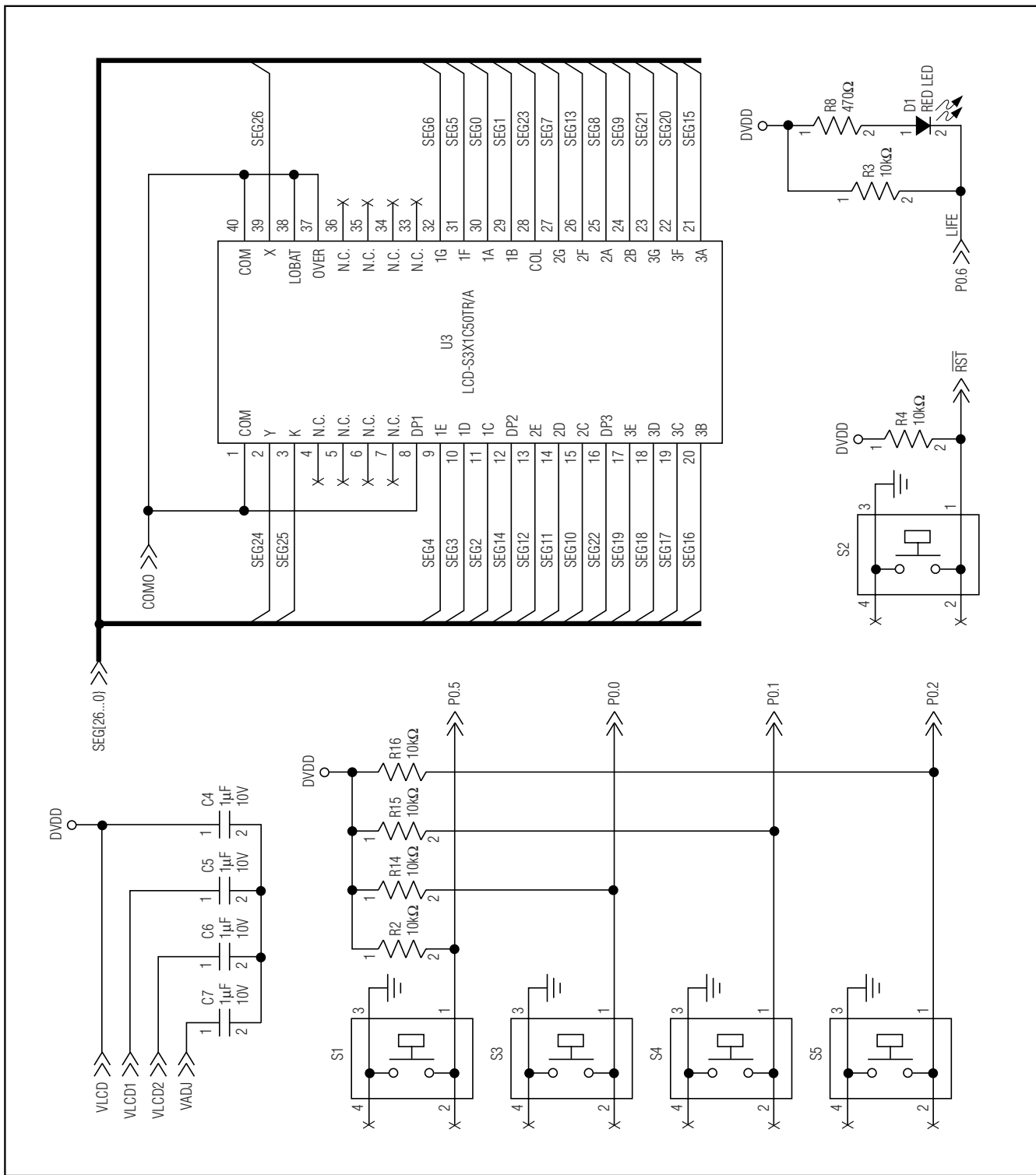

Figure 7. MAXQ3120 Evaluation Kit Power Schematics—LCD, Switches (Sheet 3 of 4)

MAXQ3120 Evaluation Kit

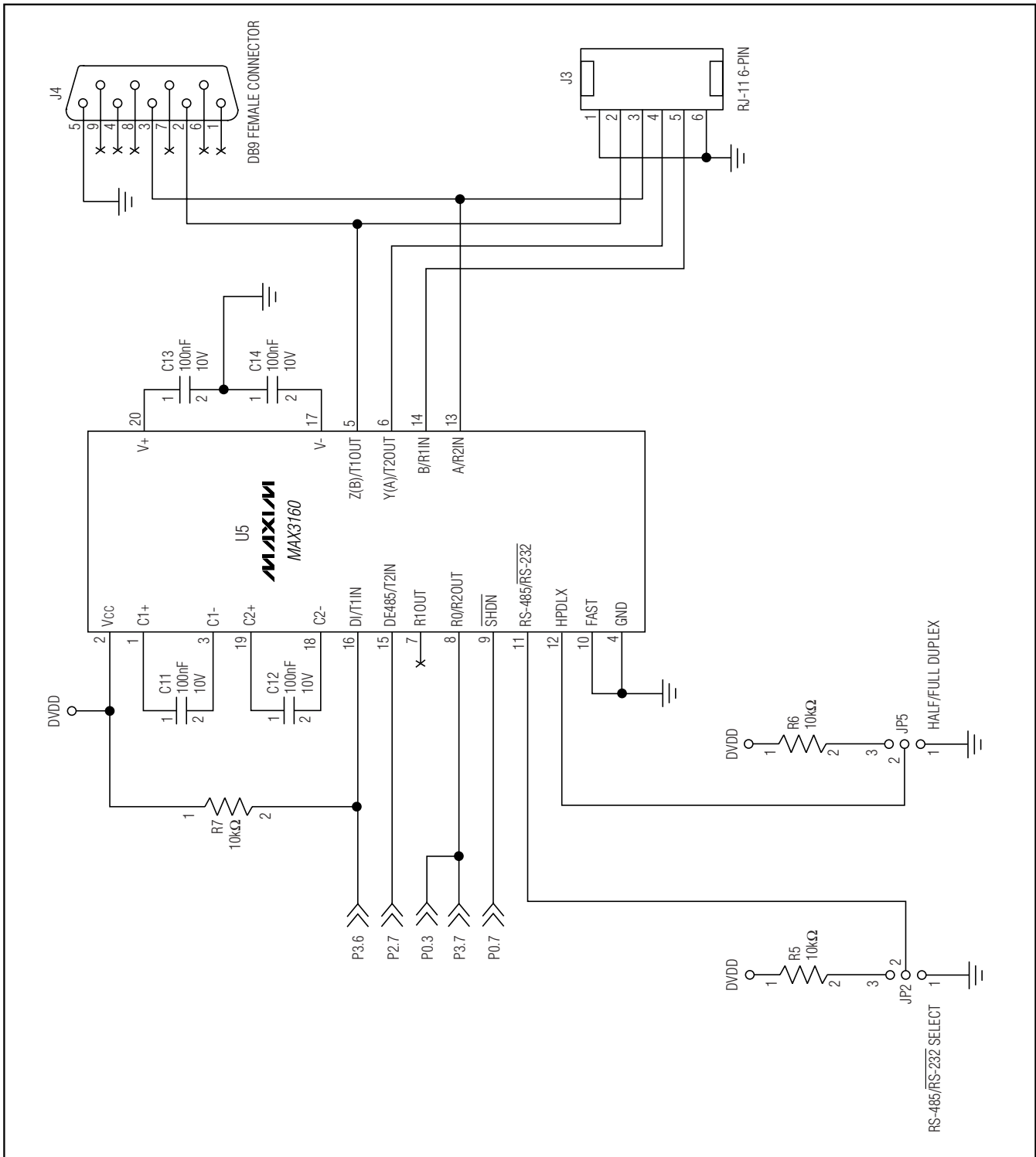

Figure 8. MAXQ3120 Evaluation Kit Power Schematics—Serial (Sheet 4 of 4)

