

General Description

This IGBT is produced using advanced MagnaChip's Field Stop Trench IGBT Technology, which provides high performance, excellent quality and high ruggedness.

This device is for motor control.

Features

- High ruggedness for motor control
- $V_{CE(sat)}$ positive temperature coefficient
- Very soft, fast recovery anti-parallel diode
- Low EMI
- Maximum junction temperature 175°C

Applications

- Inverter for motor control

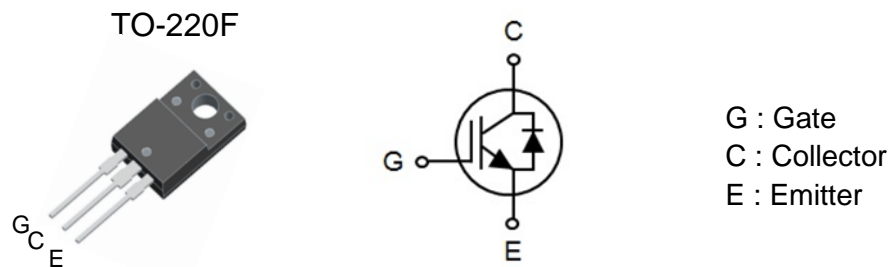

Package outline and symbol

G : Gate
C : Collector
E : Emitter

Maximum Ratings

Parameter	Symbol	Rating	Unit
Collector-emitter voltage	V_{CE}	650	V
DC collector current, limited by T_{vjmax}	I_C	$T_C=25^\circ C$	30
		$T_C=100^\circ C$	15
Pulsed collector current, t_p limited by T_{vjmax}	I_{Cpuls}	60	A
Diode forward current, limited by T_{vjmax}	I_F	$T_C=25^\circ C$	30
		$T_C=100^\circ C$	15
Diode pulsed current, t_p limited by T_{vjmax}	I_{Fpuls}	60	A
Gate-emitter voltage	V_{GE}	± 20	V
Power dissipation	P_D	$T_C=25^\circ C$	48
		$T_C=100^\circ C$	24
Short circuit withstand time $V_{CC} \leq 360V, V_{GE} = 15V, T_{vj} = 150^\circ C$	t_{sc}	5	μs
Operating Junction temperature range	T_{vj}	-40~175	$^\circ C$
Storage temperature range	T_{stg}	-55~150	$^\circ C$

Thermal Characteristics

Parameter	Symbol	Rating	Unit
Thermal resistance junction-to-ambient	$R_{th(j-a)}$	62	$^\circ C/W$
Thermal resistance junction-to-case for IGBT	$R_{th(j-c)}$	3.0	
Thermal resistance junction-to-case for Diode	$R_{th(j-c)}$	5.0	

Ordering Information

Part Number	Marking	Temp. Range	Package	Packing	RoHS Status
MBF15T65PEH	15T65PEH	-55~150°C	TO-220F	Tube	Halogen Free

Electrical Characteristics (T_{vj} = 25°C unless otherwise specified)

Parameter	Symbol	Conditions	Min	Typ	Max	Unit
Static Characteristics						
Collector-emitter breakdown voltage	BV _{CES}	I _C = 2mA, V _{GE} = 0V	650	-	-	V
Collector-emitter saturation voltage	V _{CE(sat)}	I _C = 15A, V _{GE} = 15V	T _{vj} = 25°C	1.65	2.00	V
			T _{vj} = 175°C	1.90		
Diode forward voltage	V _F	V _{GE} = 0V, I _F = 15A	T _{vj} = 25°C	1.85	2.30	V
			T _{vj} = 175°C	1.95		
Gate-emitter threshold voltage	V _{GE(th)}	V _{CE} = V _{GE} , I _C = 0.5mA	4.5	5.5	6.5	V
Zero gate voltage collector current	I _{CES}	V _{CE} = 650V, V _{GE} = 0V, T _{vj} = 25°C	-	-	20	μA
Gate-emitter leakage current	I _{GES}	V _{GE} = 20V, V _{CE} = 0V	-	-	±100	nA
Dynamic Characteristics						
Total gate charge	Q _G	V _{CE} = 520V, I _C = 15A, V _{GE} = 15V	-	61		nC
Gate-emitter charge	Q _{GE}		-	11		
Gate-collector charge	Q _{GC}		-	35		
Input capacitance	C _{ies}	V _{CE} = 25V, V _{GE} = 0V, f = 1MHz	-	1129	-	pF
Output capacitance	C _{oes}		-	57	-	
Reverse transfer capacitance	C _{res}		-	31	-	
Switching Characteristics						
Turn-on delay time	t _{d(on)}	V _{GE} = 15V, V _{CC} = 400V, I _C = 15A, R _G = 10Ω, Inductive Load, T _{vj} = 25°C	-	19	-	ns
Rise time	t _r		-	27	-	
Turn-off delay time	t _{d(off)}		-	128	-	
Fall time	t _f		-	32	-	μJ
Turn-on switching energy	E _{on}		-	270	-	
Turn-off switching energy	E _{off}		-	86	-	
Total switching energy	E _{ts}	-	356	-		
Turn-on delay time	t _{d(on)}	V _{GE} = 15V, V _{CC} = 400V, I _C = 15A, R _G = 10Ω, Inductive Load, T _{vj} = 175°C	-	17	-	ns
Rise time	t _r		-	29	-	
Turn-off delay time	t _{d(off)}		-	150	-	
Fall time	t _f		-	130	-	μJ
Turn-on switching energy	E _{on}		-	342	-	
Turn-off switching energy	E _{off}		-	288	-	
Total switching energy	E _{ts}	-	630	-		
Reverse recovery time	t _{rr}	I _F = 15A, di _F /dt = 200A/μs, T _{vj} = 25°C	-	150	-	ns
Reverse recovery current	I _{rr}		-	5.2	-	A
Reverse recovery charge	Q _{rr}		-	390	-	nC
Reverse recovery time	t _{rr}	I _F = 15A, di _F /dt = 200A/μs, T _{vj} = 175°C	-	207	-	ns
Reverse recovery current	I _{rr}		-	6.1	-	A
Reverse recovery charge	Q _{rr}		-	631	-	nC

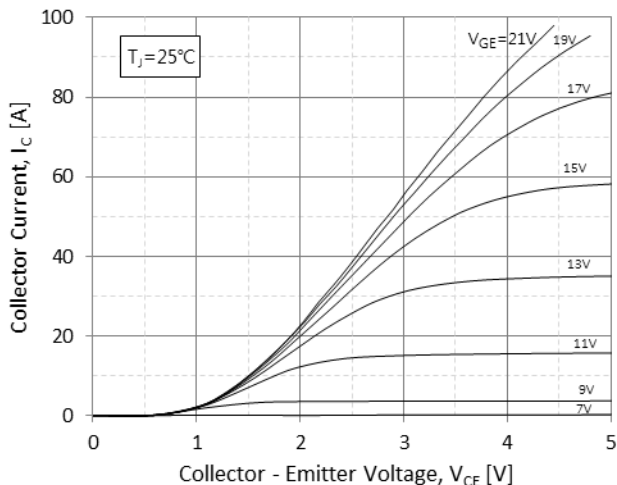

Fig.1 Typical Output Characteristics($T_J=25^\circ\text{C}$)

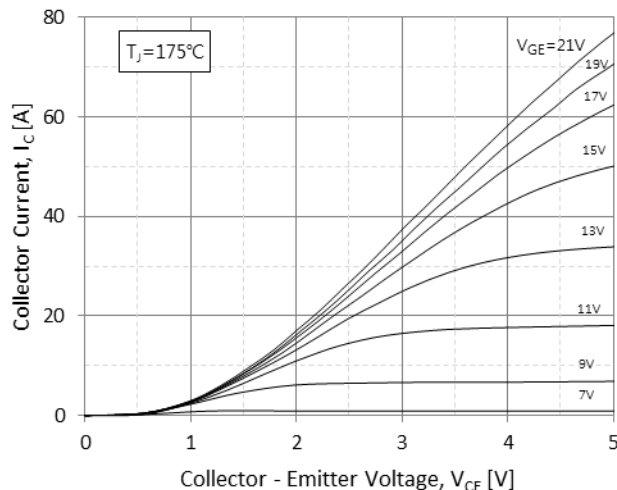

Fig.2 Typical Output Characteristics($T_J=175^\circ\text{C}$)

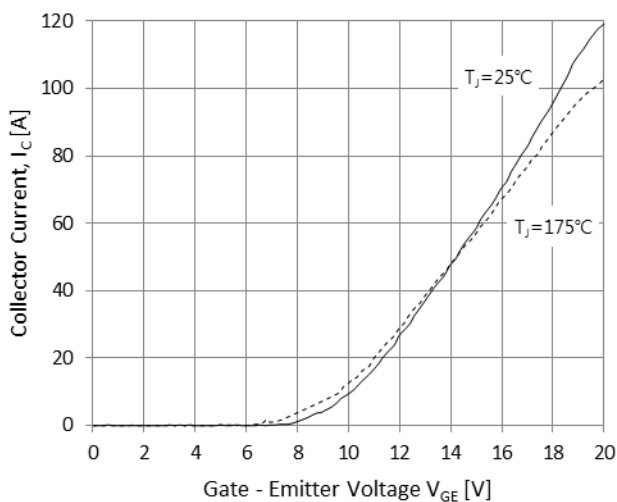

Fig.3 Typical Transfer Characteristics

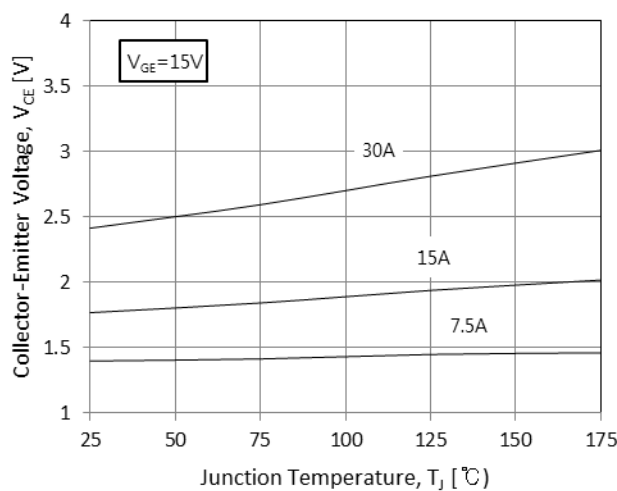

Fig.4 Typical Collector-Emitter Saturation Voltage - Junction Temperature

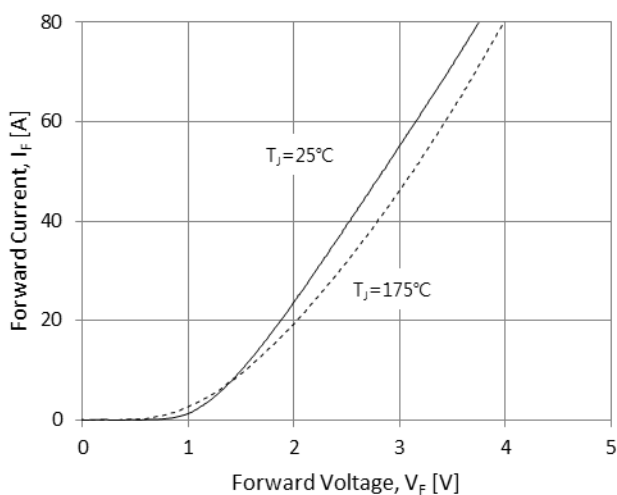

Fig.5 Diode Forward Characteristics

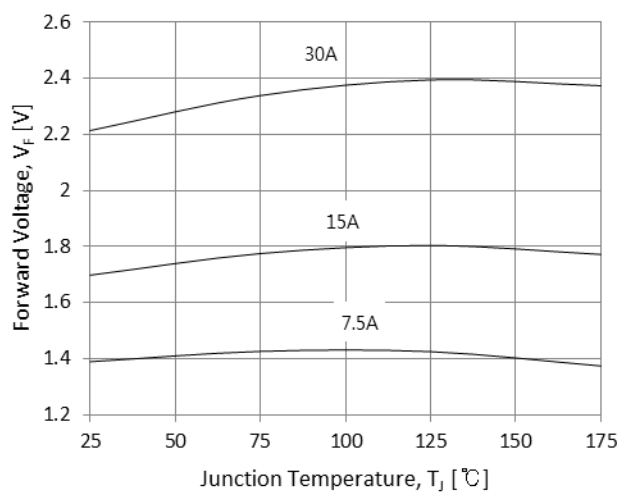

Fig.6 Diode Forward-Junction Temperature

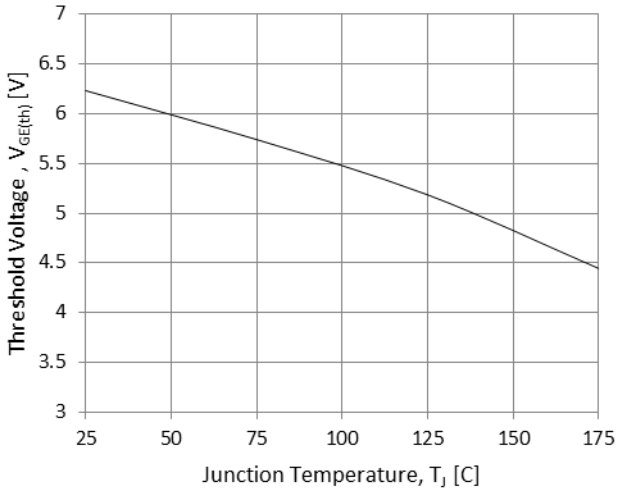

Fig.7 Threshold Voltage-Junction Temperature

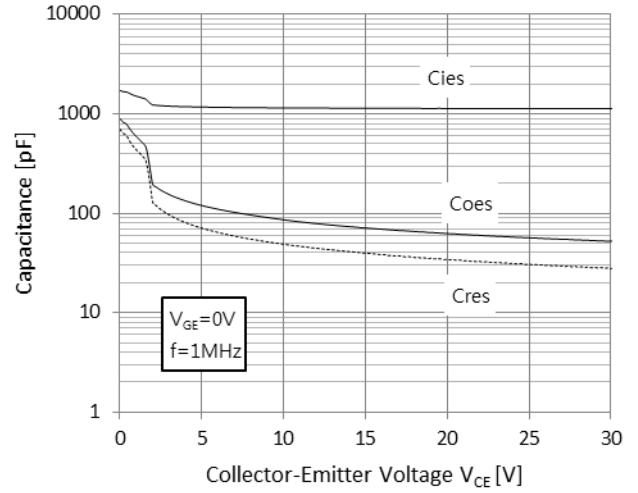

Fig.8 Typical Capacitance

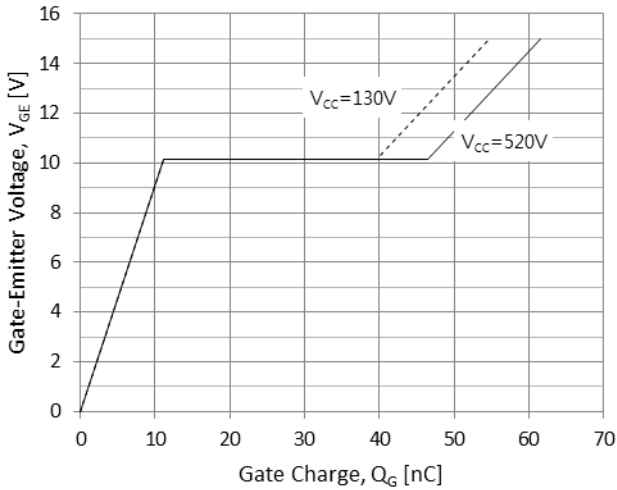

Fig.9 Typical Gate Charge

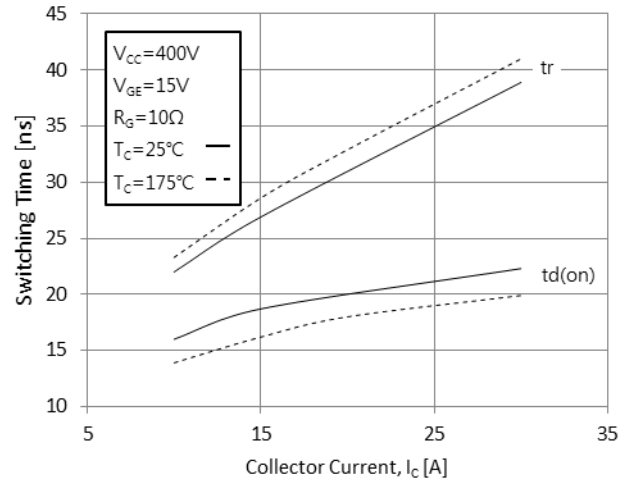

Fig.10 Typical Turn on-Collector Current

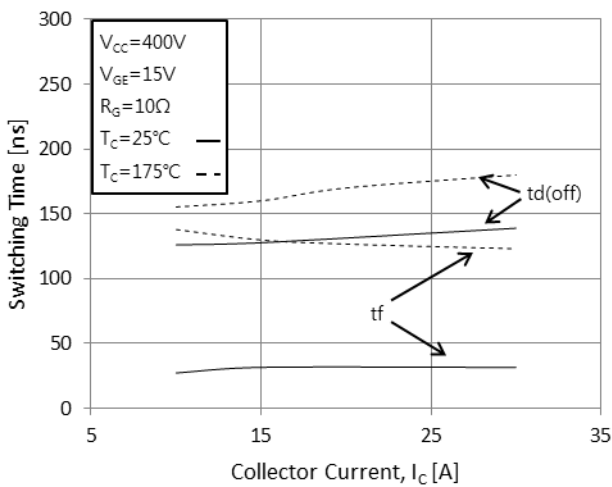

Fig.11 Typical Turn off-Collector Current

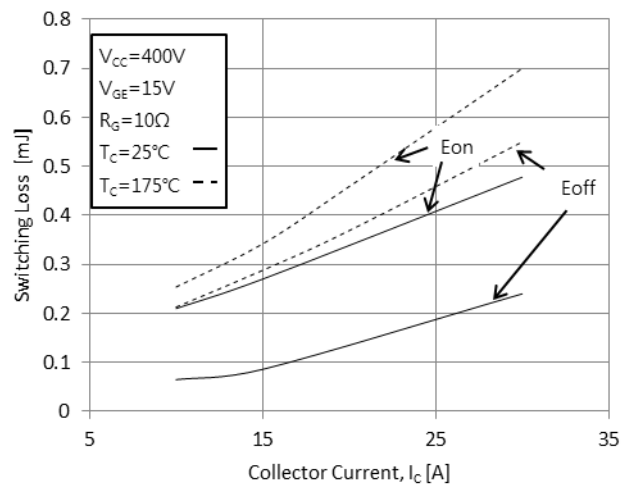

Fig.12 Switching Loss-Collector Current

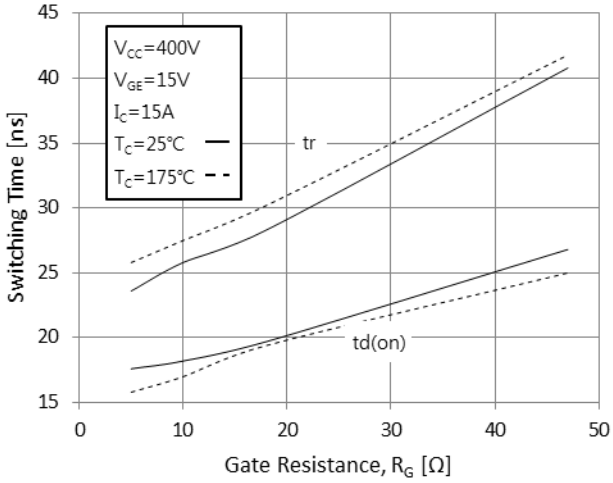

Fig.13 Turn on Characteristics-Gate Resistance

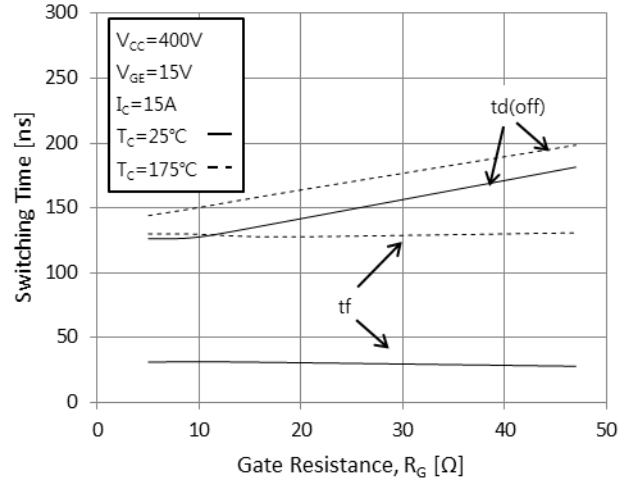

Fig.14 Turn off Characteristics-Gate Resistance

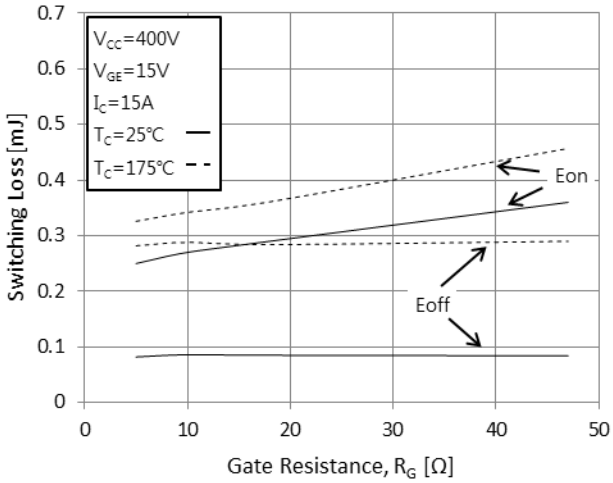

Fig.15 Switching Loss-Gate Resistance

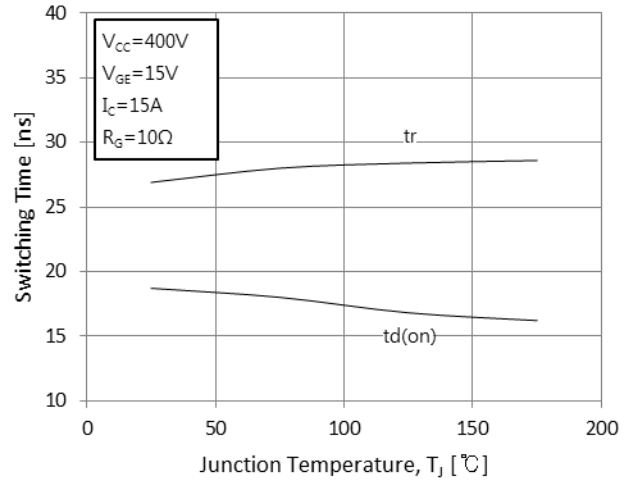

Fig.16 Turn on Characteristics-Junction Temperature

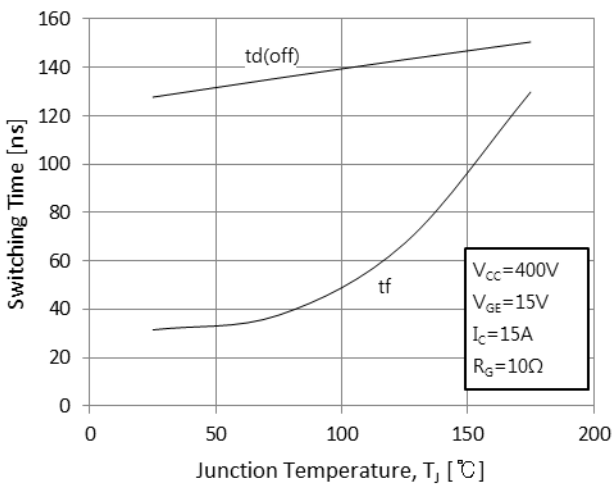

Fig.17 Turn off Characteristics-Junction Temperature

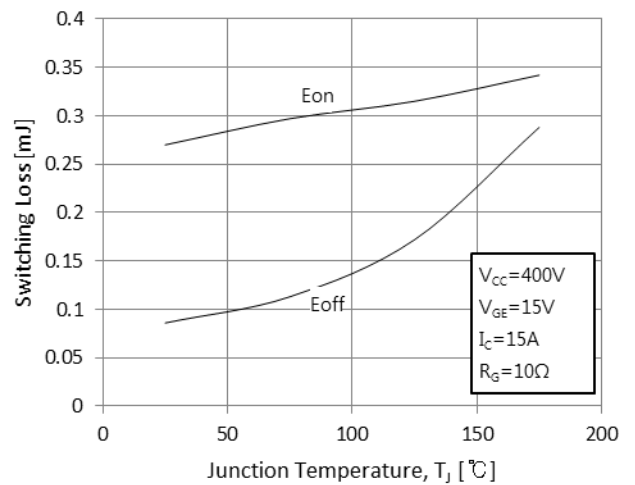

Fig.18 Switching Loss-Junction Temperature

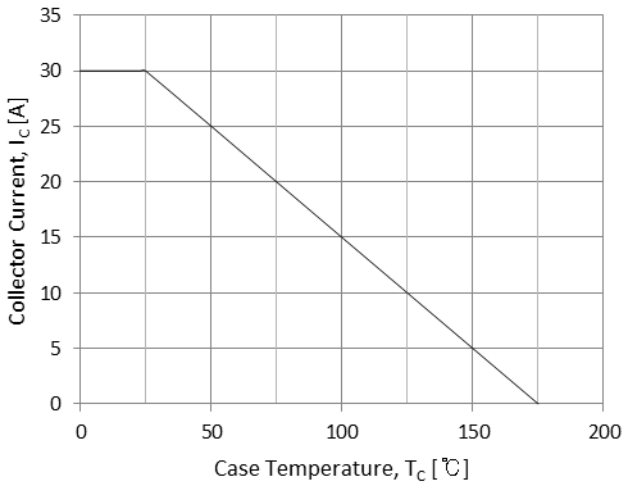

Fig.19 Case Temperature-Collector Current

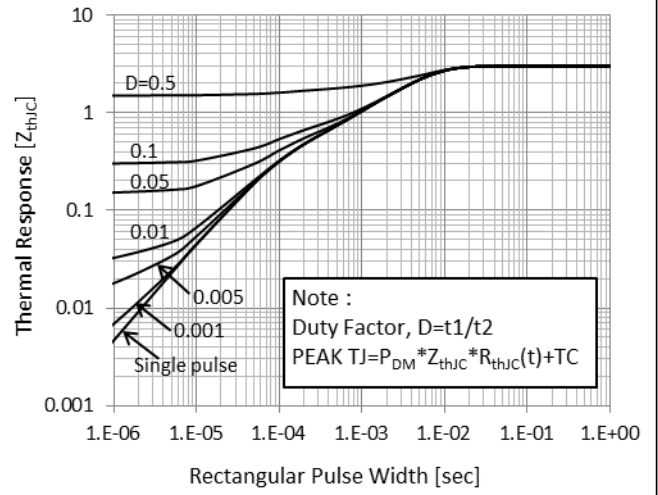

Fig.20 IGBT Transient Thermal Impedance

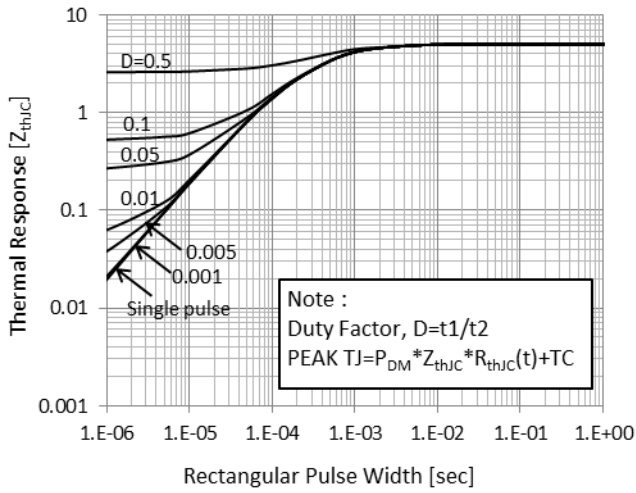
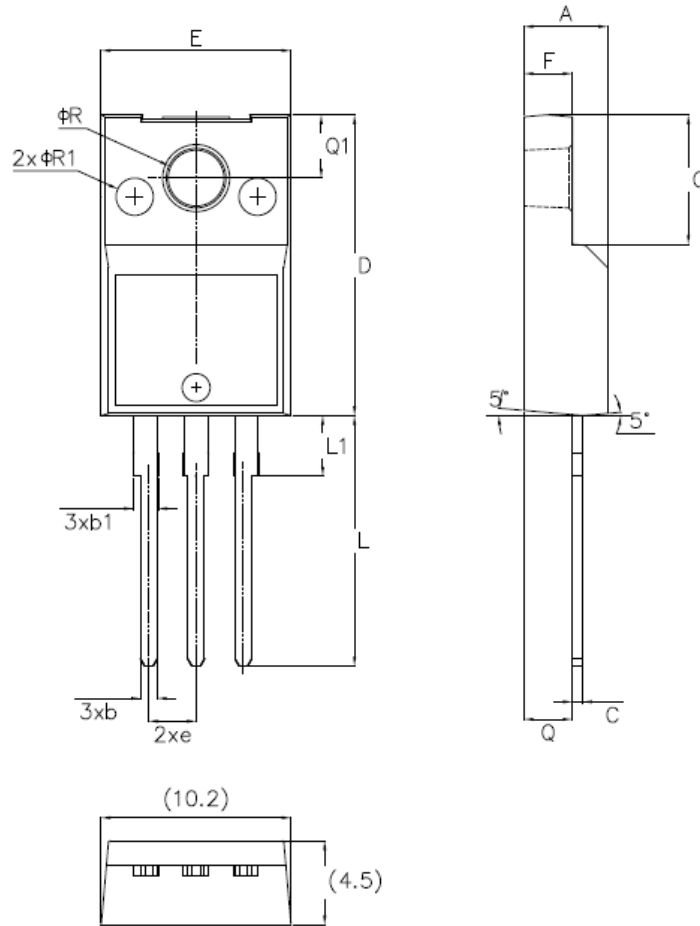

Fig.21 FRD Transient Thermal Impedance

Package outline dimension

TO-220F



Symbol	Dimension (mm)		
	Min	Nom	Max
A	4.3	-	4.8
b	0.5	-	1.0
b1	0.95	-	1.7
C	0.4	-	0.8
D	14.5	-	16.4
E	9.6	-	10.4
e	2.54 BSC		
F	2.5	-	3.1
G	6.2	-	7.2
L	12.2	-	14.2
L1	2.9	-	4.7
Q	2.3	-	2.9
Q1	2.4	-	3.5
ΦR	3.00	-	3.4
ΦR1	2.0		

DISCLAIMER:

The Products are not designed for use in hostile environments, including, without limitation, aircraft, nuclear power generation, medical appliances, and devices or systems in which malfunction of any Product can reasonably be expected to result in a personal injury. Seller's customers using or selling Seller's products for use in such applications do so at their own risk and agree to fully defend and indemnify Seller.

MagnaChip reserves the right to change the specifications and circuitry without notice at any time. MagnaChip does not consider responsibility for use of any circuitry other than circuitry entirely included in a MagnaChip product. [MagnaChip](#) is a registered trademark of MagnaChip Semiconductor Ltd.