

MBF9041BB

SAW Antenna Duplexer (700 to 1000 MHz)

GENERAL DESCRIPTION

The MBF9041BB is the SAW antenna duplexer for the frequency range of 700 to 1000 MHz. This SAW Duplexer integrates RF filters at Tx and Rx side, and matching circuit into PKG. This helps to save the space and weight greatly in the target application such as mobile telephone. This SAW Duplexer has very low insertion loss by using high quality package. Due to high harmonics characteristics, total number of components at RF circuit can be minimized. Thanks to high isolation performance, high sensitivity can be expected. Low insertion loss at Tx saves the power consumption of mobile telephone which prolong the battery life.

FEATURES

- Complying Standard AMPS, IS-95, IS-136
- Thin package: less than 1.5 mm in height
- PKG I/O Impedance: 50 Ω

PRODUCT DESCRIPTION

Package Type

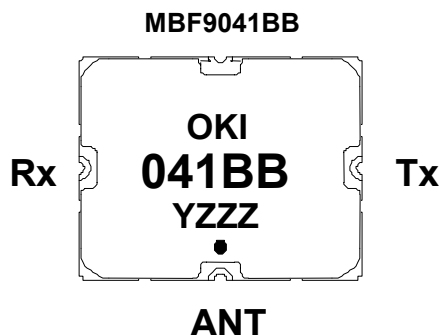

Construction

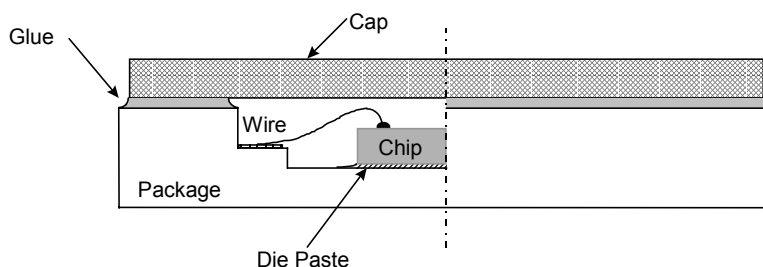

Cross-section of MBF9041BB

PIN ASSIGNMENT & DESCRIPTION

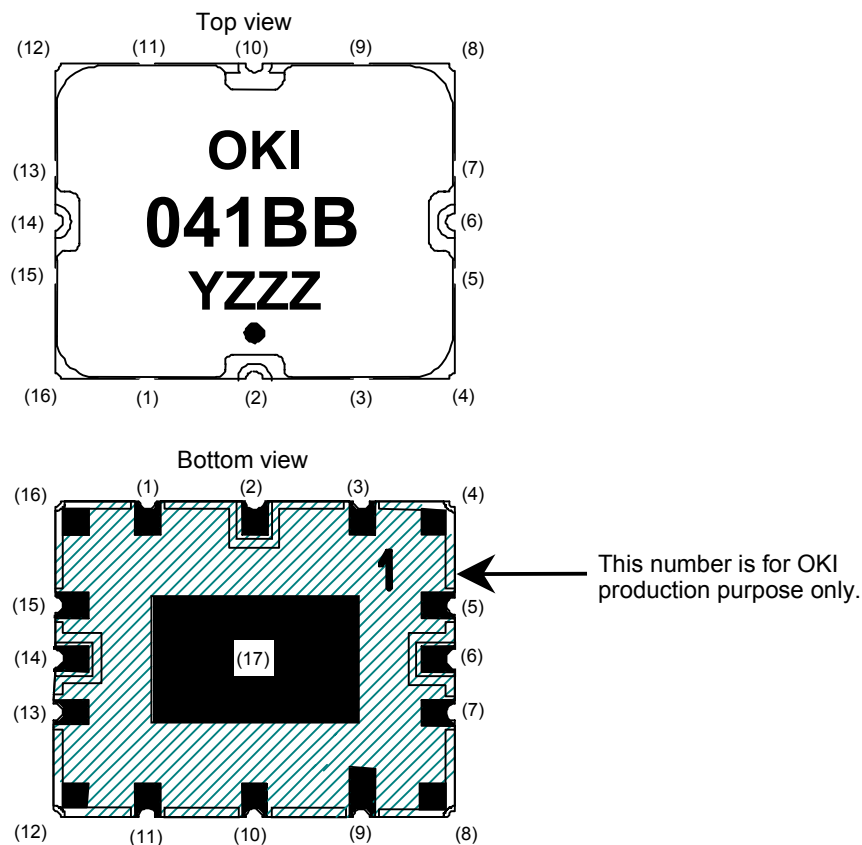

Pin No.	Name	Description
1	GND	Ground Pin
2	ANT	Antenna Pin
3	GND	Ground Pin
4	GND	No Connection *
5	GND	Ground Pin
6	Tx	Transmitting Terminal Pin
7	GND	Ground Pin
8	GND	No Connection *
9	GND	Ground Pin
10	GND	Ground Pin
11	GND	Ground Pin
12	GND	No Connection *
13	GND	Ground Pin
14	Rx	Receiving Terminal Pin
15	GND	Ground Pin
16	GND	No Connection *
17	GND	Ground Pin

Note) Pin No. 4, 8, 12 and 16 are for manufacturer's internal use. Do not solder to the PCB.

ABSOLUTE MAXIMUM RATINGS

Parameter	Symbol	Rating		Unit
		Min.	Max.	
Operating Temperature	T _a	-30	+85	°C
Storage Temperature	T _{STG}	-40	+85	°C
Maximum Input Power	P _{IN}	—	2.0	W

RECOMMENDED OPERATING CONDITIONS

Parameter	Symbol	Rating		Unit
		Min.	Max.	
Operating Temperature	T _a	-30	+85	°C

ELECTRICAL CHARACTERISTICS

(Ta = -30 to +85°C)

Parameter	Condition	Mini.	Typ.	Max.	Unit/Notes	
Tx → Antenna						
a)	Insertion loss	824 to 849 MHz	—	2.4	2.8	dB
b)	Passband ripple	824 to 849 MHz	—	1.0	1.5	dB
c)	VSWR	824 to 849 MHz	—	1.7	2.0	
d)	Absolute attenuation	869 to 894 MHz	40	42	—	dB
		1648 to 1698 MHz	30	33	—	dB
		2472 to 2547 MHz	30	33	—	dB
Antenna → Rx						
a)	Insertion loss	869 to 894 MHz	—	3.4	3.8	dB
b)	Passband ripple	869 to 894 MHz	—	1.4	2.0	dB
c)	VSWR	869 to 894 MHz	—	1.8	2.1	
d)	Absolute attenuation	824 to 849 MHz	50	53	—	dB
		930 to 1200 MHz	33	38	—	dB
		1200 to 1500 MHz	40	45	—	dB
		1500 to 1800 MHz	40	45	—	dB
Isolation TX → RX						
a)	Absolute attenuation	824 to 849 MHz	55	—	—	dB
Input Power						
a)	Average power	—	—	—	2	W

Note: Electrical characteristics described above is guaranteed by the following measurement and equipment condition.

- 1) Test board: See next page
- 2) Network analyzer: ADVANTEST R3767CH with 3 port test adapter (R3966K)

Test Board

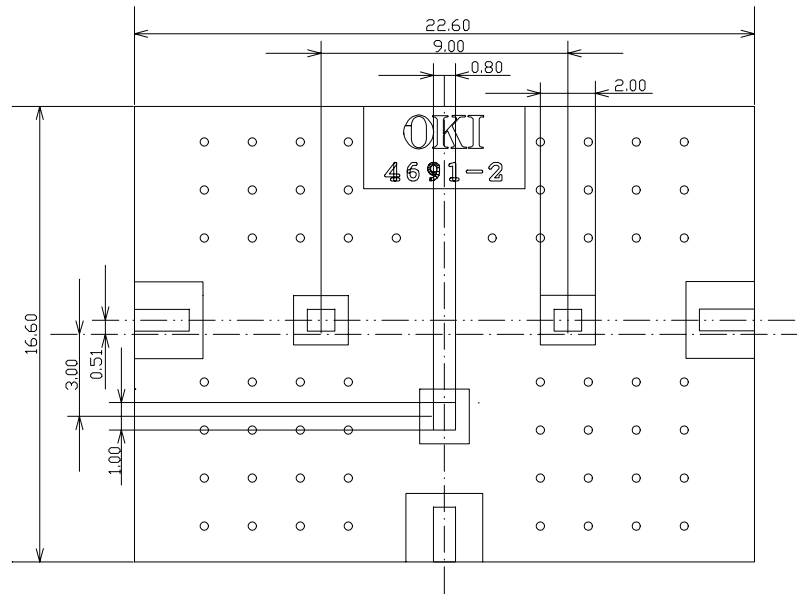

MARKING

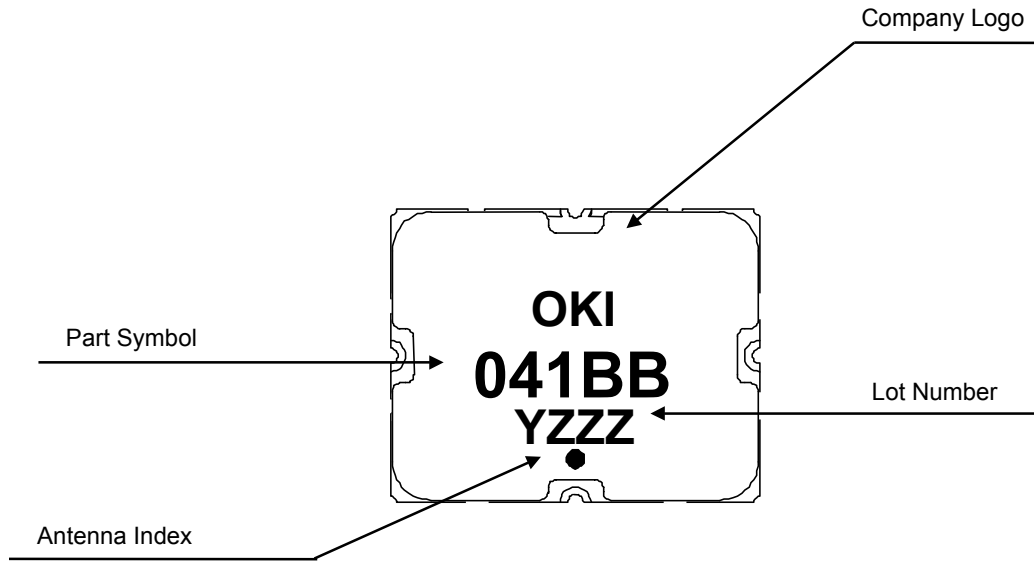

Note)
Lot Number
Y: Last number of year
ZZZ: Serial number

REFLOW TEMPERATURE PROFILE

The figure below shows recommended temperature profile of infrared reflow and air reflow. Other type of reflow is not recommended.

The maximum reflow count is 2 times. Washing of this device after reflow process is prohibited.

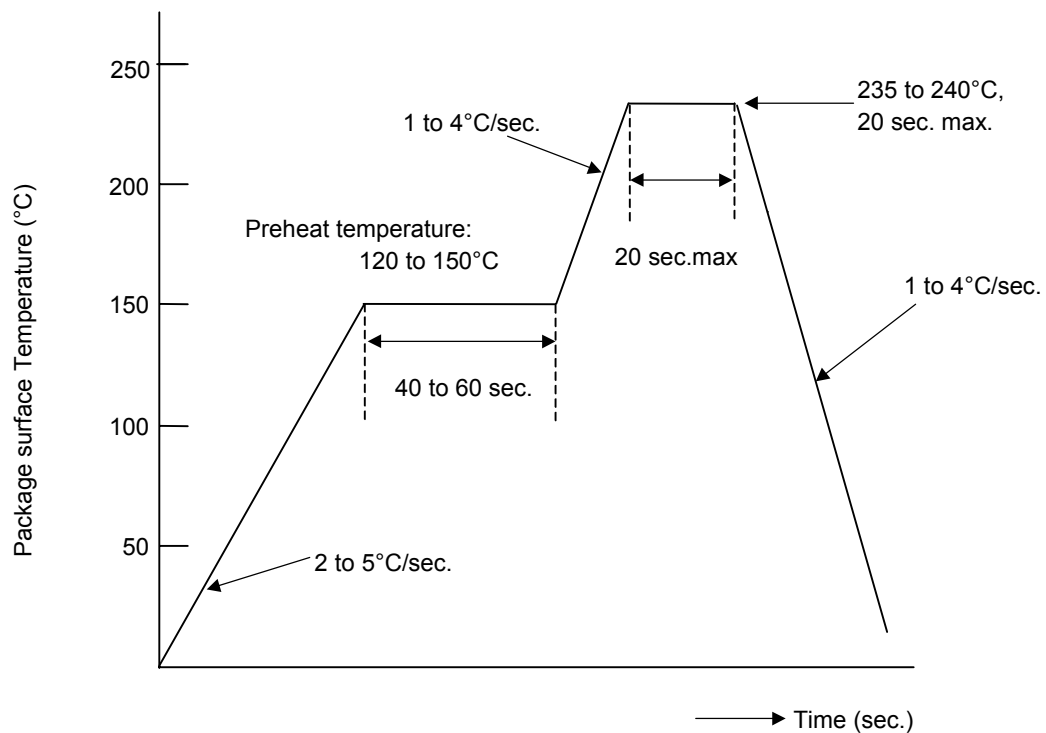

RECOMMENDATION FOR SOLDER PAD PATTERN

The solder pad pattern should be designed by customers because it depends on the electrical performance of the customers' system. Following is an example of solder pad pattern which is used in OKI's package evaluation board. Please be noted that this is for reference purpose only.

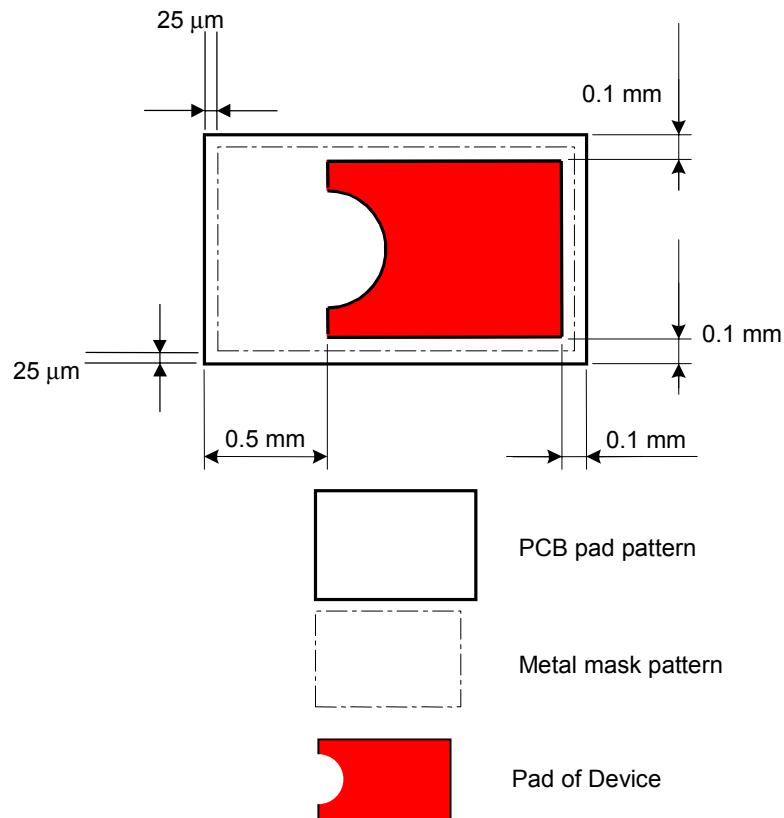

Please pay attention to the following items to maintain electrical performance.

- (1) Metal mask pattern for cream solder should be 25 μm smaller on each side. Metal mask is 0.15 mm in thickness.
- (2) As the impedance of Tx, Rx, ANT is designed for 50 Ω, please consider this for the design of mother board.
- (3) The performance of these devices is assured when GND pad (Pin 17) is connected. GND pad (Pin 17) should be soldered in the same way as above.

NOTICE

1. The information contained herein can change without notice owing to product and/or technical improvements. Before using the product, please make sure that the information being referred to is up-to-date.
2. The outline of action and examples for application circuits described herein have been chosen as an explanation for the standard action and performance of the product. When planning to use the product, please ensure that the external conditions are reflected in the actual circuit, assembly, and program designs.
3. When designing your product, please use our product below the specified maximum ratings and within the specified operating ranges including, but not limited to, operating voltage, power dissipation, and operating temperature.
4. Oki assumes no responsibility or liability whatsoever for any failure or unusual or unexpected operation resulting from misuse, neglect, improper installation, repair, alteration or accident, improper handling, or unusual physical or electrical stress including, but not limited to, exposure to parameters beyond the specified maximum ratings or operation outside the specified operating range.
5. Neither indemnity against nor license of a third party's industrial and intellectual property right, etc. is granted by us in connection with the use of the product and/or the information and drawings contained herein. No responsibility is assumed by us for any infringement of a third party's right which may result from the use thereof.
6. The products listed in this document are intended for use in general electronics equipment for commercial applications (e.g., office automation, communication equipment, measurement equipment, consumer electronics, etc.). These products are not authorized for use in any system or application that requires special or enhanced quality and reliability characteristics nor in any system or application where the failure of such system or application may result in the loss or damage of property, or death or injury to humans. Such applications include, but are not limited to, traffic and automotive equipment, safety devices, aerospace equipment, nuclear power control, medical equipment, and life-support systems.
7. Certain products in this document may need government approval before they can be exported to particular countries. The purchaser assumes the responsibility of determining the legality of export of these products and will take appropriate and necessary steps at their own expense for these.
8. No part of the contents contained herein may be reprinted or reproduced without our prior permission.

Copyright 2000 Oki Electric Industry Co., Ltd.