

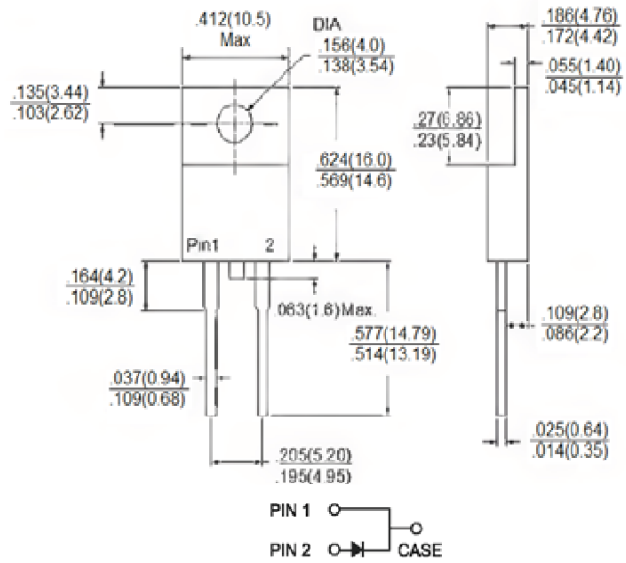

Features

- ✧ Plastic material used carriers Underwriters Laboratory Classification 94V-0
- ✧ Metal silicon junction, majority carrier conduction
- ✧ Low power loss, high efficiency
- ✧ High current capability, low forward voltage drop
- ✧ High surge capability
- ✧ For use in low voltage, high frequency inverters, free wheeling, and polarity protection applications
- ✧ Guard-ring for overvoltage protection
- ✧ High temperature soldering guaranteed: 260°C/10 seconds, 0.25"(6.35mm) from case
- ✧ Green compound with suffix "G" on packing code & prefix "G" on datecode



Mechanical Data

- ✧ Cases: JEDEC TO-220AC molded plastic body
- ✧ Terminals: Pure tin plated, lead free, solderable per MIL-STD-750, Method 2026
- ✧ Polarity: As marked
- ✧ Mounting position: Any
- ✧ Mounting torque: 5 in. - lbs, max
- ✧ Weight: 1.86 grams

Dimensions in inches and (millimeters)

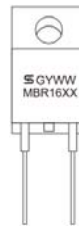

Marking Diagram

- MBR16XX = Specific Device Code
- G = Green Compound
- Y = Year
- WW = Work Week

Maximum Ratings and Electrical Characteristics

Rating at 25 °C ambient temperature unless otherwise specified.

Single phase, half wave, 60 Hz, resistive or inductive load.

For capacitive load, derate current by 20%

Type Number	Symbol	MBR 1635	MBR 1645	MBR 1650	MBR 1660	MBR 1690	MBR 16100	MBR 16150	Units
Maximum Recurrent Peak Reverse Voltage	V_{RRM}	35	45	50	60	90	100	150	V
Maximum RMS Voltage	V_{RMS}	24	31	35	42	63	70	105	V
Maximum DC Blocking Voltage	V_{DC}	35	45	50	60	90	100	150	V
Maximum Average Forward Rectified Current	$I_{F(AV)}$	16							A
Peak Repetitive Forward Current (Rated VR, Square Wave, 20KHz)	I_{FRM}	32							A
Peak Forward Surge Current, 8.3 ms Single Half Sine-wave Superimposed on Rated Load (JEDEC method)	I_{FSM}	150							A
Peak Repetitive Reverse Surge Current (Note 1)	I_{RRM}	1.0	0.5					A	
Maximum Instantaneous Forward Voltage at: (Note 2) IF=16A, TA=25°C IF=16A, TA=125°C	V_F	0.63 0.57	0.75 0.65	0.85 0.75		0.95 0.92		V	
Maximum Instantaneous Reverse Current @ TA=25 °C at Rated DC Blocking Voltage @ TA=125 °C	I_R	0.5 15	0.5 10	0.3 7.5		0.1 5		mA mA	
Voltage Rate of Change (Rated VR)	dV/dt	10,000							V/uS
Typical Junction Capacitance	Cj	500							pF
Maximum Typical Thermal Resistance	RθJC	3							°C/W
Operating Junction Temperature Range	TJ	- 65 to + 150							°C
Storage Temperature Range	TSTG	- 65 to + 175							°C

Note 1: 2.0uS Pulse Width, f=1.0KHz

Note 2: Pulse Test : 300uS Pulse Width, 1% Duty Cycle

RATINGS AND CHARACTERISTIC CURVES (MBR1635 THRU MBR16150)

FIG. 1- FORWARD CURRENT DERATING CURVE

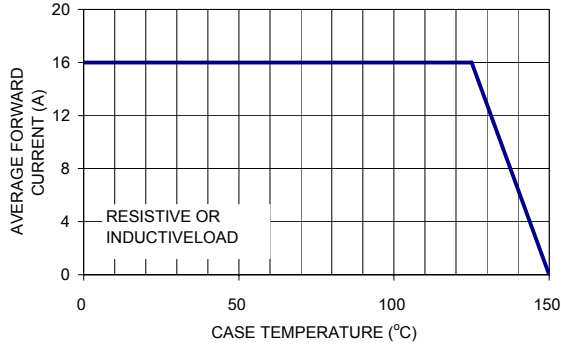

FIG. 2- MAXIMUM NON-REPETITIVE FORWARD SURGE CURRENT

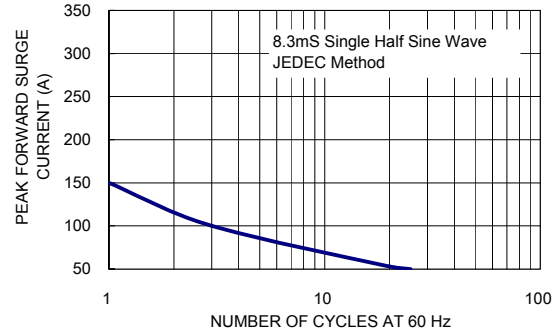

FIG. 3- TYPICAL INSTANTANEOUS FORWARD CHARACTERISTICS

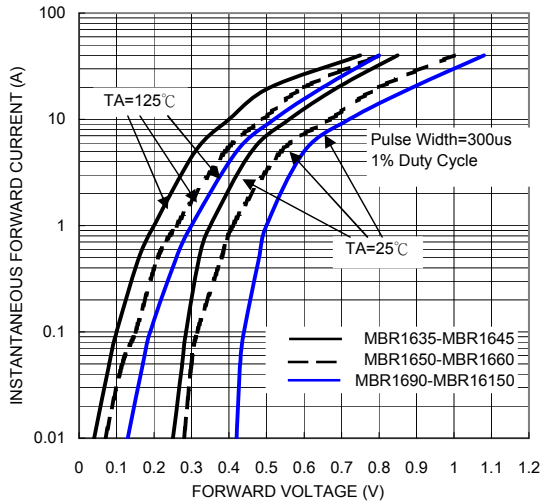

FIG. 4- TYPICAL REVERSE CHARACTERISTICS

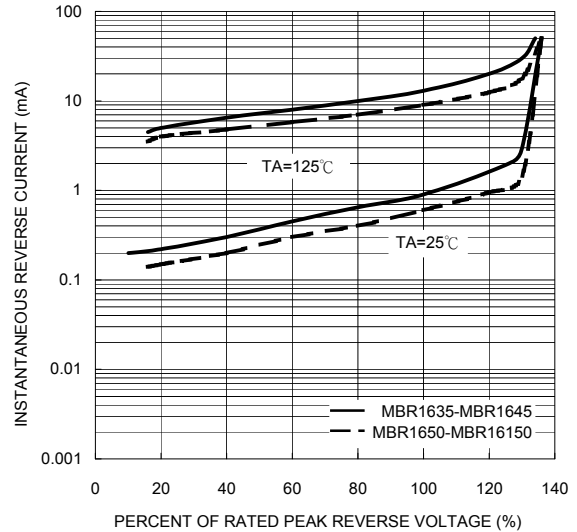

FIG. 5- TYPICAL JUNCTION CAPACITANCE

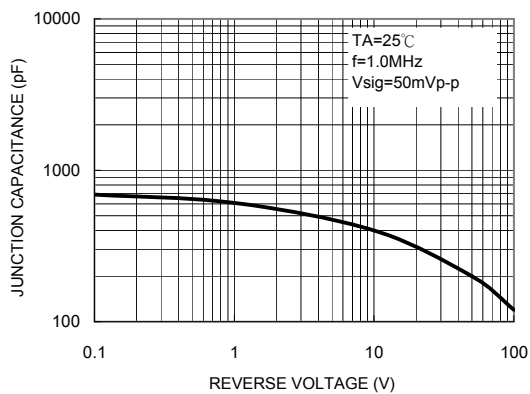

FIG. 6- TYPICAL TRANSIENT THERMAL CHARACTERISTICS

