

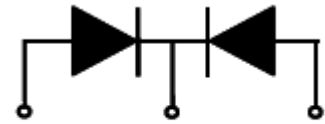

## Product Specification

GOODARK Type  
**MBR20100CT**

Construction : Schottky Barrier Rectifier  
Application : For General Purpose  
(Manufacturer) :  
Suzhou Goodark Electronics Co.,Ltd  
Prepared on Sep. 17<sup>th</sup>, 2008  
Prepared: R & D Department  
Approval: QRA Department



1. Anode 2. Cathode 3. Anode

**SCHOTTKY BARRIER RECTIFIER**  
**20 AMPERES**  
**100 VOLTS**

### CONTENTS

1. Package Outline
2. Marking
3. Features& Mechanical Characteristics
4. Maximum Ratings and Electrical Characteristics
5. Rating and characteristic Curves
6. Packing Specification PACKAGING SPECIFICATION
7. Description of Box Label

### 1. Package Outline (TO220-AB)

UNIT:mm

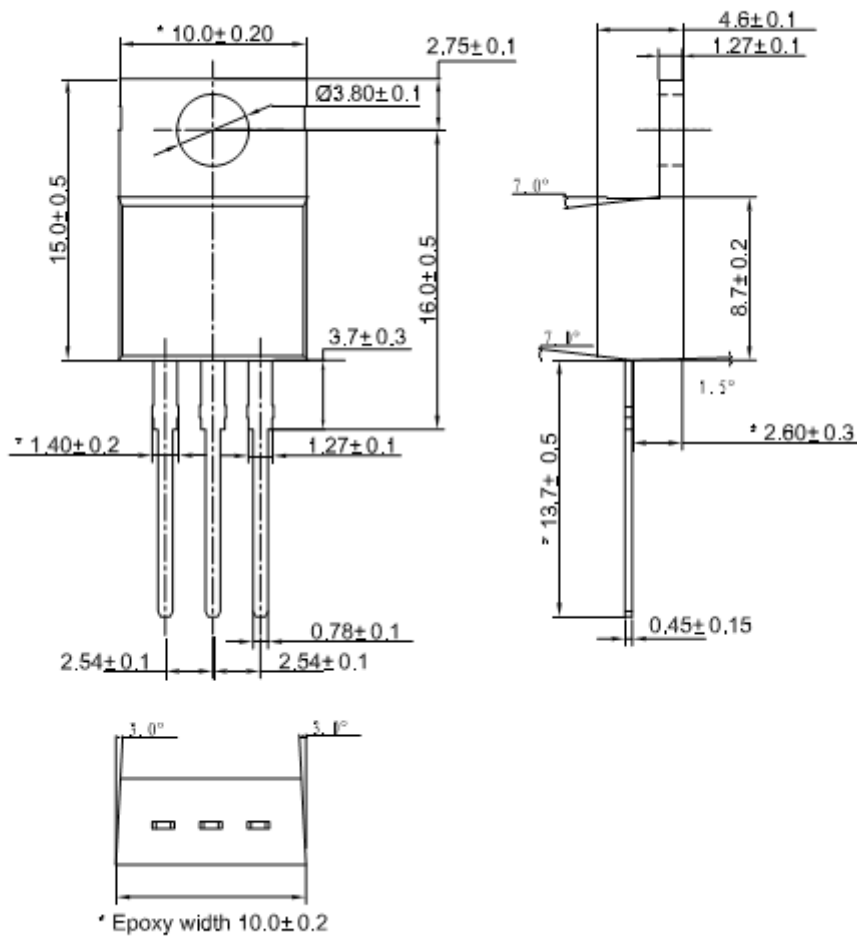

Lead Frame Material : Copper      Plating: Pure Tin Plating

## 2.MARKING

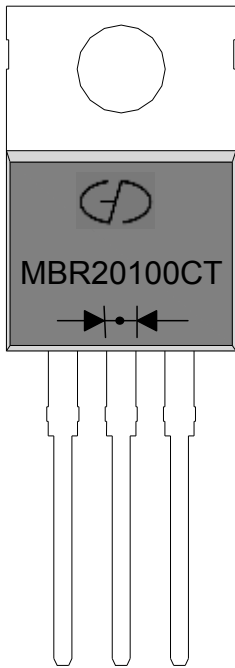

1. Part Name : MBR20100CT

2. Logo Mark: 

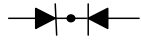
3. Polarity: 



### 3.Features& Mechanical Characteristics

#### Features

- Plastic package has underwriters Laboratory Flammability Classification 94V-0
- Dual rectifier construction, positive center tap
- Metal of silicon rectifier, majority carrier conduction
- Low forward voltage, high efficiency
- Guarding for over voltage protection
- For use in low voltage, high frequency inverters,
- Free wheeling, and polarity protection applications

#### Mechanical Characteristics

- Case: Epoxy, Molded
- Weight: 1.9grams (approximately)
- Finish: All External Surfaces Corrosion Resistant and Terminal Leads are Readily Solderable
- Lead Temperature for Soldering Purposes: 260°C Max.for10 sec
- Shipped 50 units per plastic tube

### 4.Maximum Ratings and Electrical Characteristics

MAXIMUM RATINGS and ELECTRICAL CHARACTERISTICS(TC=25°C unless otherwise moted)					
PARAMETER	TEST CONDITIONS		SYMBOL	MBR20100CT	UNIT
Maximum repetitive peak reverse voltage			VRRM	100	V
Working peak reverse voltage			VRWM	100	V
Maximum DC blocking voltage			VDC	100	V
Maximum average forward rectified current at Tc=105°C total device per diode			IF(AV)	20 10	A
Peak forward surge current 8.3ms single half sine-wave superimposed on rated load per diode			IFSM	150	A
Peak repetitive reverse current per leg at tp=2.0us , 1KHz			IRRM	0.5	A
Voltage rate of change (rated VR)			DV/dt	10000	V/us
Operating junction temperature range			TJ	-65 to+150	°C
Storage temperature range			TSTG	-65 to+150	°C
Maximum instantaneous forward voltage per leg	IF=10A	TC=25°C	VF	0.80	V
	IF=10A	TC=125°C		0.70	
	IF=20A	Tc=25°C	VF	0.95	V
IF=20A	Tc=125°C		0.85		
Maximum reverse current per leg at working peak Reverse voltage			TJ=25°C TJ=100°C	IR	100 6 uA mA

#### Thermal Characteristics Ta=25°C unless otherwise noted

Symbol	Parameter	Max	Unit
RθJC	Thermal Resistance, Junction to Case per Leg	2.0	°C /W
RθJA	Thermal Resistance, Junction to Ambient per Leg	62.5	°C /W

#### Note:

1. Screw mounting with 4-40 screw, where washer diameteris≤4.9mm(0.19 " )
2. Pulse test:300us pulse width,1% duty cycle





## 5. Rating and Characteristic Curves

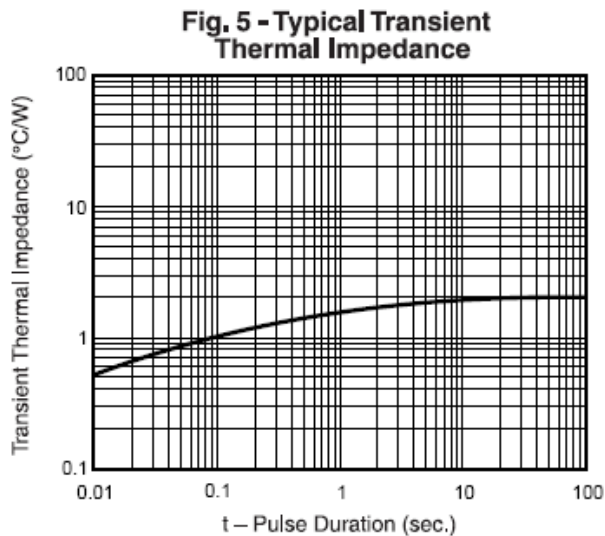
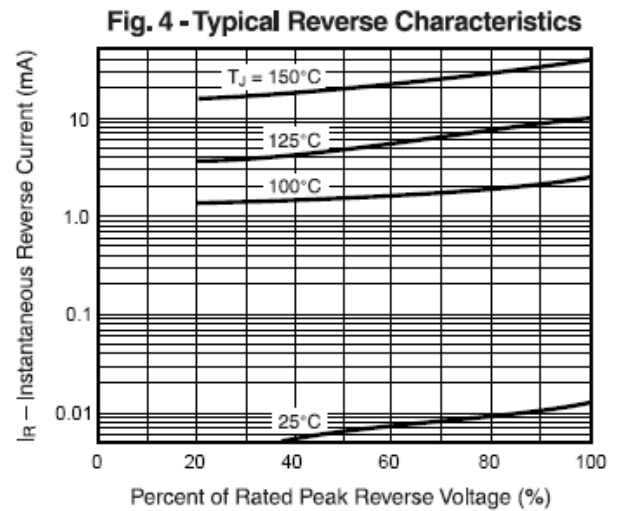
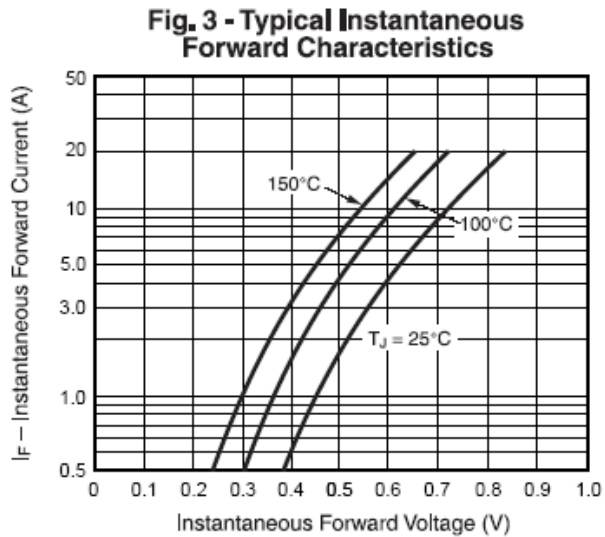
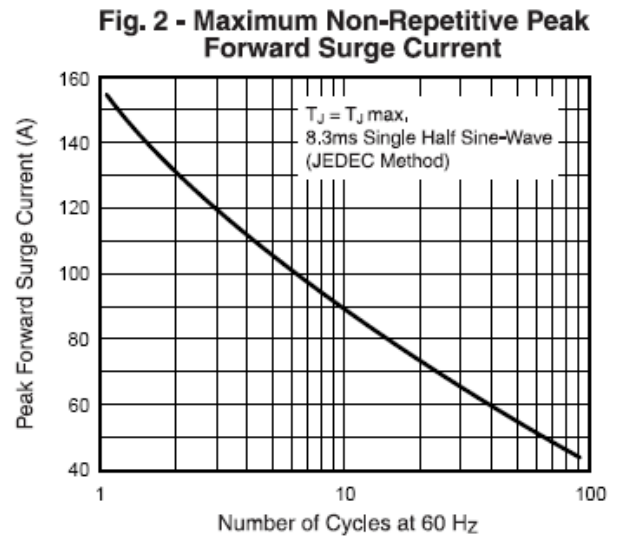
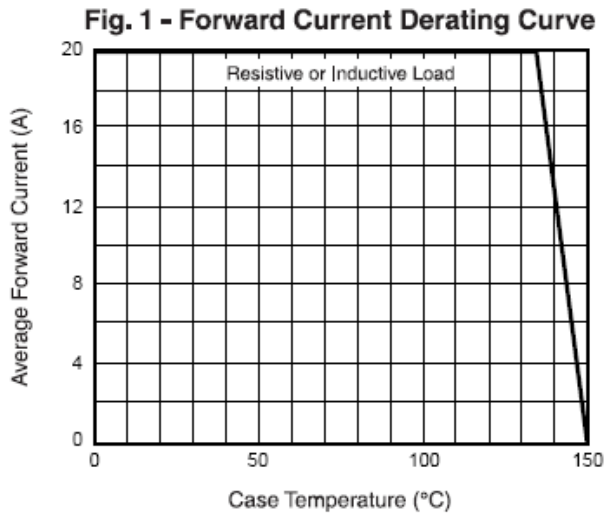

(TA = 25 °C unless otherwise noted)



## 6. Packing Specification

	
<p>1 ) Tube : 50units</p>	<p>2 ) Inner Box: 20 tube(1000units)</p>
	
<p>3 ) Outer Box: 10 inner box (10,000units)</p>	

## 7. DESCRIPTION of BOX LABEL

	<p>TYPE:        Q'TY:        P/O NO:        LOT NO:</p>
<p>1) Inner Box Label</p>	<p>2) Inner Box Label</p>
	<p>TYPE:        Q'TY:        P/O NO:</p>
<p>3) Outer Box Label</p>	<p>4) Outer Box Label</p>