

20Amp. Schottky Barrier Rectifiers
MBR20150E3

$I_{F(AV)}$	$2 \times 10A$
V_{RRM}	150V
T_j	175°C
V_F	0.68V

Features

- 175°C operating junction temperature
- Low V_F and low I_R type
- Metal silicon junction, major carrier conduction
- 20A total (10A per diode leg)
- Guardring for stress protection
- Low power loss, high efficiency
- High surge capability
- High temperature soldering guaranteed : 260°C/10s, 0.25”(6.35mm) from case
- For use in low voltage, high frequency inverters, free wheeling, and polarity protection application
- RoHS compliant package

Mechanical Data

- Case: JEDEC TO-220AB molded plastic
- Mounting Position: Any
- Weight: 0.08 ounce, 2.24 grams
- Terminals: Pure tin plated, lead-free, solderable per MIL-STD-750 method 2026
- Epoxy: UL 94V-0 rate flame retardant
- Mounting Torque : 5 in-lbs max

Equivalent Circuit

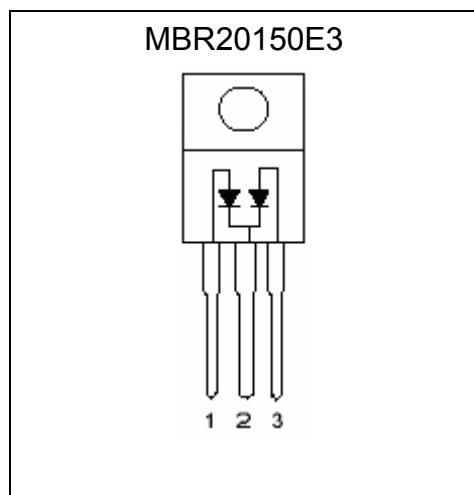

Outline

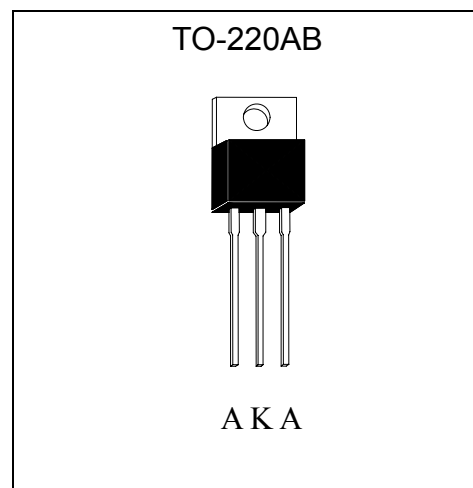



Maximum Ratings and Electrical Characteristics (Per Diode Leg)

(Rating at 25°C ambient temperature unless otherwise specified. Single phase, half wave, 60Hz, resistive or inductive load. For capacitive load, derate current by 20%.)

Parameter	Symbol	Min.	Typ.	Max.	Units
Maximum Recurrent peak reverse voltage	V _{RRM}			150	V
Maximum RMS voltage	V _{RMS}			100	V
Maximum DC blocking voltage	V _{DC}			150	V
Maximum instantaneous forward voltage at (Note 1)	V _F		0.68	0.85	V
				IF=10A, Tc=125°C	
				IF=20 A, Tc=25°C	
				IF=20A, Tc=125°C	
Maximum Average forward rectified current @ Tc=134°C	I _{F(AV)}			10	A
				Per Diode	
Non-repetitive peak forward surge current @ 8.3ms single half sine wave superimposed on rated load (JEDEC method)	I _{FSM}			150	A
Peak repetitive reverse surge current, Tj<175°C (Note 1)	I _{RRM}			3	A
Maximum instantaneous reverse current at	I _R			5	μA
				VR=150 V, Tc=125°C	5
Voltage rate of change, (rated V _R)	dV/dt			10,000	V/μs
Typical junction capacitance @ f=1MHz and applied 5V reverse voltage	C _J		168		pF
ESD susceptibility (Note 2)				8000	V
Storage temperature range	T _{stg}	-65		+175	°C
Operating junction temperature range	T _J	-65		+175	°C

Notes : 1. 2.0μs pulse width, f=1.0kHz
 2. Human body model, 1.5kΩ in series with 100pF

Thermal Data

Parameter	Symbol	Value	Unit
Maximum Thermal Resistance, Junction-to-case	R _{th,j-c}	2.0	°C/W
Maximum Thermal Resistance, Junction-to-ambient	R _{th,j-a}	60	°C/W

Ordering Information

Device	Package	Shipping
MBR20150E3-0-UB-S	TO-220 (Pb-free lead plating)	50 pcs / tube, 20 tubes/ box , 4 boxes/carton

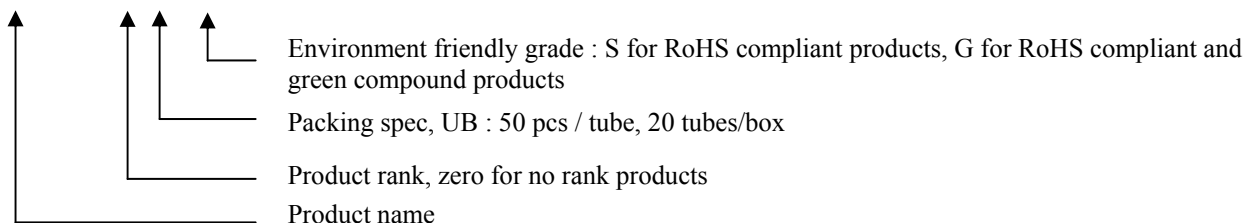

Characteristic Curves

Forward Current Derating Curve

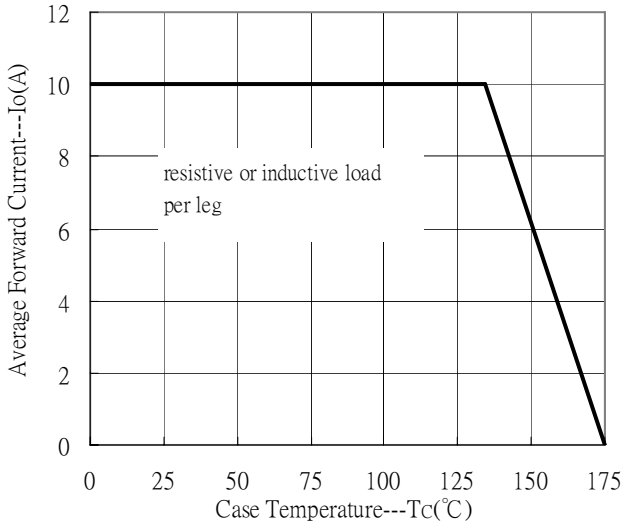

Forward Current vs Forward Voltage

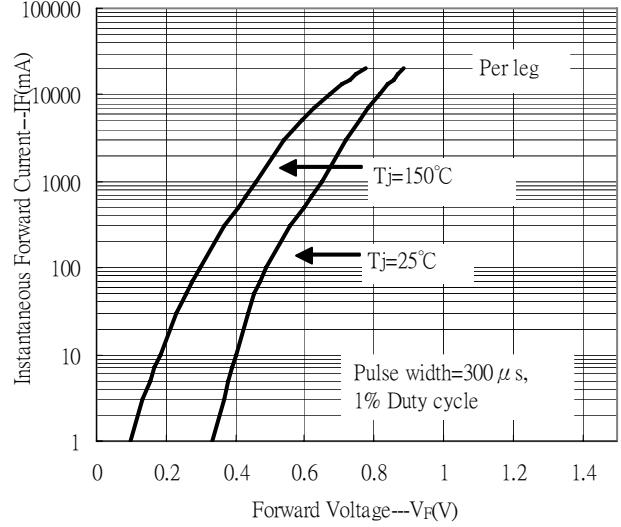

Reverse Leakage Current vs Reverse Voltage

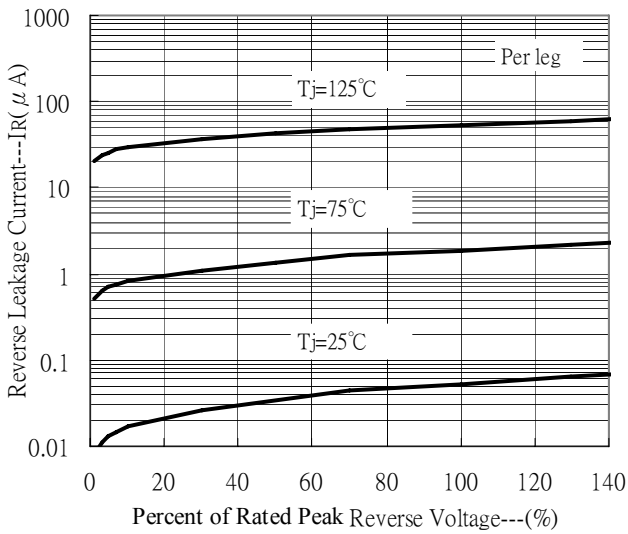

Junction Capacitance vs Reverse Voltage

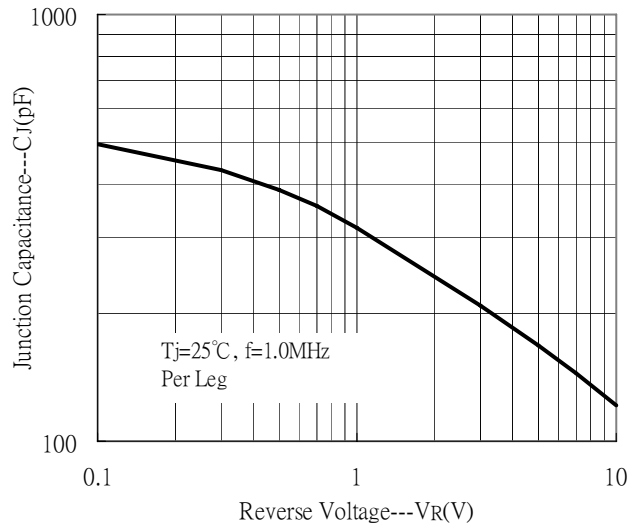

Recommended wave soldering condition

Product	Peak Temperature	Soldering Time
Pb-free devices	260 +0/-5 °C	5 +1/-1 seconds

Recommended temperature profile for IR reflow

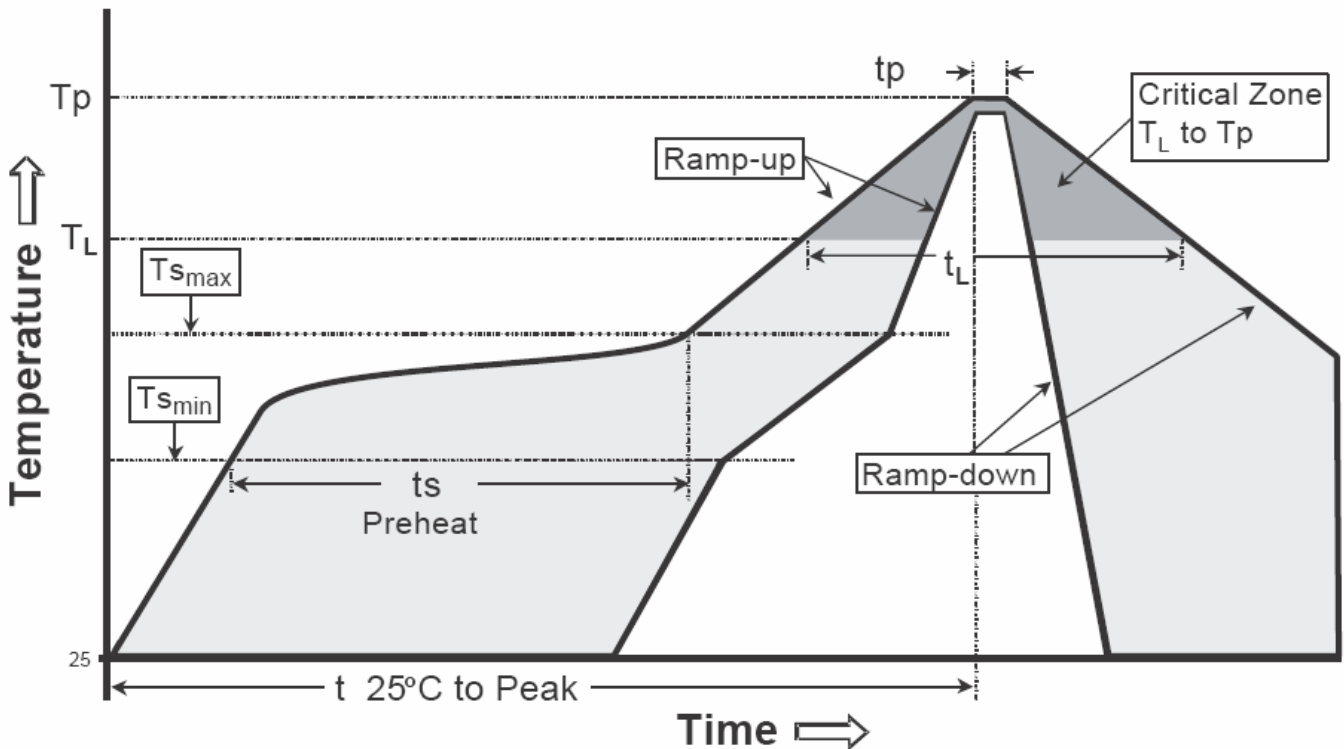

Profile feature	Sn-Pb eutectic Assembly	Pb-free Assembly
Average ramp-up rate (T _{smax} to T _p)	3°C/second max.	3°C/second max.
Preheat		
-Temperature Min(T _{s min})	100°C	150°C
-Temperature Max(T _{s max})	150°C	200°C
-Time(t _{s min} to t _{s max})	60-120 seconds	60-180 seconds
Time maintained above:		
-Temperature (T _L)	183°C	217°C
- Time (t _L)	60-150 seconds	60-150 seconds
Peak Temperature(T _P)	240 +0/-5 °C	260 +0/-5 °C
Time within 5°C of actual peak temperature(tp)	10-30 seconds	20-40 seconds
Ramp down rate	6°C/second max.	6°C/second max.
Time 25 °C to peak temperature	6 minutes max.	8 minutes max.

Note : All temperatures refer to topside of the package, measured on the package body surface.

TO-220AB Dimension

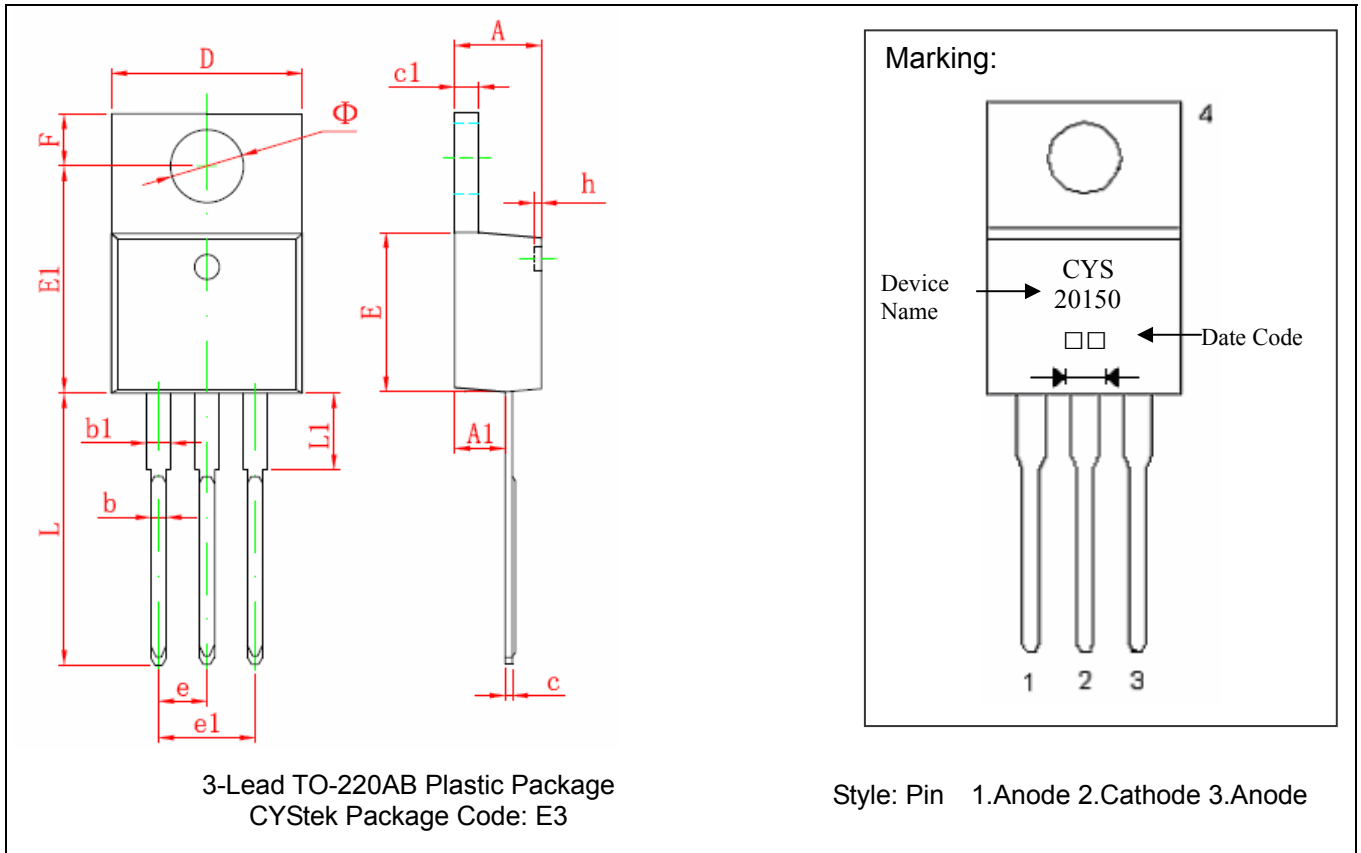

3-Lead TO-220AB Plastic Package
 CYStek Package Code: E3

Style: Pin 1.Anode 2.Cathode 3.Anode

*: Typical

DIM	Millimeters		Inches		DIM	Millimeters		Inches	
	Min.	Max.	Min.	Max.		Min.	Max.	Min.	Max.
A	4.470	4.670	0.176	0.184	E1	12.060	12.460	0.475	0.491
A1	2.520	2.820	0.099	0.111	e	2.540*		0.100*	
b	0.710	0.910	0.028	0.036	e1	4.980	5.180	0.196	0.204
b1	1.170	1.370	0.046	0.054	F	2.590	2.890	0.102	0.114
c	0.310	0.530	0.012	0.021	h	0.000	0.300	0.000	0.012
c1	1.170	1.370	0.046	0.054	L	13.400	13.800	0.528	0.543
D	10.010	10.310	0.394	0.406	L1	3.560	3.960	0.140	0.156
E	8.500	8.900	0.335	0.350	Φ	3.735	3.935	0.147	0.155

Notes: 1.Controlling dimension: millimeters.
 2.Maximum lead thickness includes lead finish thickness, and minimum lead thickness is the minimum thickness of base material.
 3.If there is any question with packing specification or packing method, please contact your local CYStek sales office.

Material:

- Lead: Pure tin plated.
- Mold Compound: Epoxy resin family, flammability solid burning class: UL94V-0.

Important Notice:

- All rights are reserved. Reproduction in whole or in part is prohibited without the prior written approval of CYStek.
- CYStek reserves the right to make changes to its products without notice.
- CYStek **semiconductor products are not warranted to be suitable for use in Life-Support Applications, or systems.**
- CYStek assumes no liability for any consequence of customer product design, infringement of patents, or application assistance.