



Dual Common-Cathode High-Voltage Schottky Barrier Rectifiers
Reverse Voltage 150 Volts Forward Current 10.0 Amperes

Features

- ◆ Guardring for overvoltage protection
- ◆ Low power loss, high efficiency
- ◆ Low forward voltage drop
- ◆ High frequency operation
- ◆ Solder Dip 260 °C, 40 seconds
- ◆ For use in high frequency inverters, free wheeling and polarity protection applications

Mechanical Data

- ◆ Case: TO-220AB, TO-220IS Epoxy meets UL-94V-0 Flammability rating
- ◆ Terminals: Matte Tin plated (E3 Suffix) leads, solderable per J-STD-002B and JESD22-B102D
- ◆ Mounting Torque: 10 in-lbs maximum
- ◆ Polarity: As marked
- ◆ Weight: 0.08 ounce, 2.24 grams

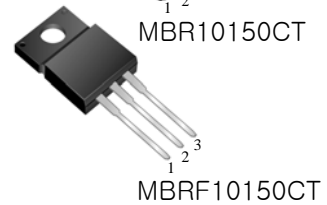
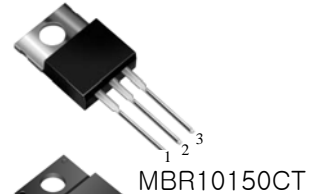

- 1 ANODE
- 2 CATHODE
- 3 ANODE

TO-220AB

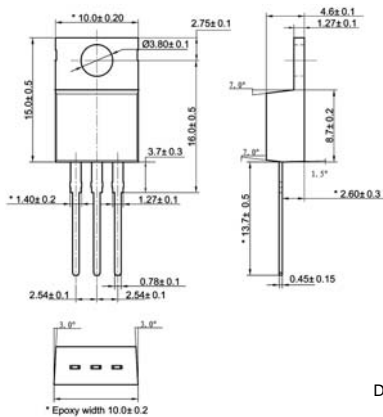

TO-220IS

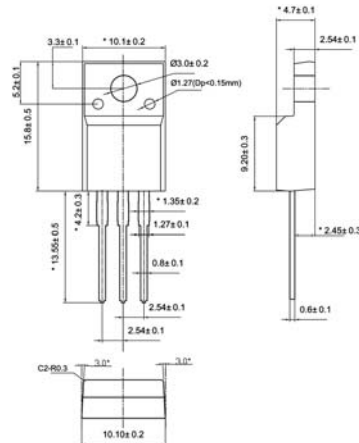

Dimensions in millimeters



MBR10150CT MBRF10150CT

Maximum Ratings and Electrical Characteristics

($T_c = 25^\circ\text{C}$ unless otherwise noted)

Parameter	Symbol	MBR10150CT	Unit
Maximum repetitive peak reverse voltage	V_{RRM}	150	Volts
Working peak reverse voltage	V_{RWM}	150	Volts
Maximum DC blocking voltage	V_{DC}	150	Volts
Maximum average forward rectified current (See Fig. 1)	$I_{F(AV)}$	10 5.0	Amps
Peak forward surge current 8.3ms single half sine-wave superimposed on rated load (JEDEC Method) per leg	I_{FSM}	160	Amps
Peak repetitive reverse current per leg at $t_p = 2.0\mu\text{s}$, 1KHz	I_{RRM}	1.0	Amp
Voltage rate of change (rated V_R)	dv/dt	10,000	V/ μs
Maximum instantaneous forward voltage per leg (Note 4) at $I_F=5.0\text{A}$, $T_J=25^\circ\text{C}$ at $I_F=5.0\text{A}$, $T_J=125^\circ\text{C}$ at $I_F=10\text{A}$, $T_J=25^\circ\text{C}$ at $I_F=10\text{A}$, $T_J=125^\circ\text{C}$	V_F	0.88 0.72 0.96 0.80	Volts
Maximum reverse current per leg at working peak reverse voltage (Note 4)	I_R	5.0 1.0	μA mA
Typical thermal resistance per leg	$R_{\theta JC}$	MBR 2.4 / MBRF 4.5	$^\circ\text{C}/\text{W}$
RMS Isolation voltage (MBRF type only) from terminals to heatsink with $t = 1.0$ second, $RH \leq 30\%$	V_{ISOL}	4500 (Note 1) 3500 (Note 2) 1500 (Note 3)	Volts
Operating junction and storage temperature range	T_J, T_{STG}	-55 to +150	$^\circ\text{C}$

- Notes:**
1. Clip mounting (on case), where lead does not overlap heatsink with 0.110" offset
 2. Clip mounting (on case), where leads do overlap heatsink
 3. Screw mounting with 4-40 screw, where washer diameter is ≤ 4.9 mm (0.19")
 4. Pulse test: 300 μs pulse width, 1% duty cycle



MBR10150CT MBRF10150CT

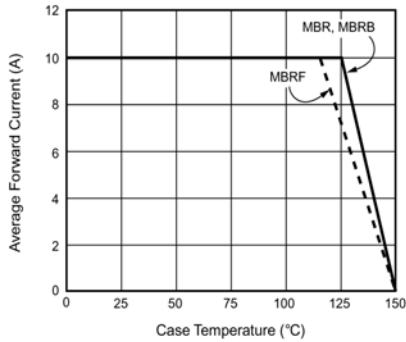

Figure 1. Forward Derating Curve (Total)

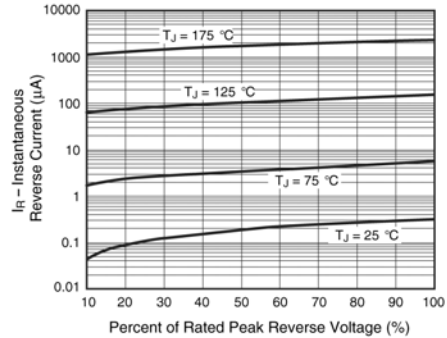

Figure 4. Typical Reverse Characteristics Per Leg

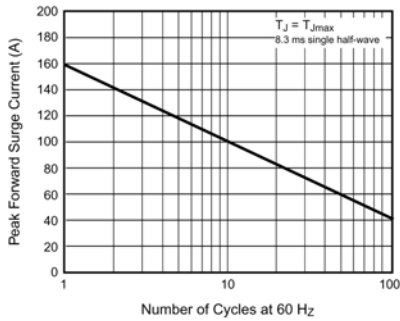

Figure 2. Maximum Non-Repetitive Peak Forward Surge Current Per Leg

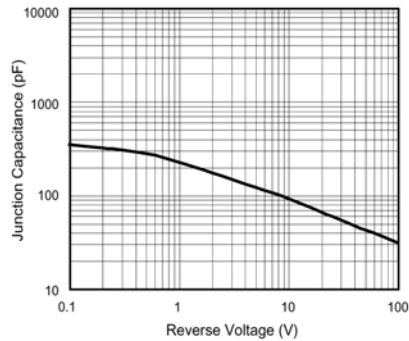

Figure 5. Typical Junction Capacitance Per Leg

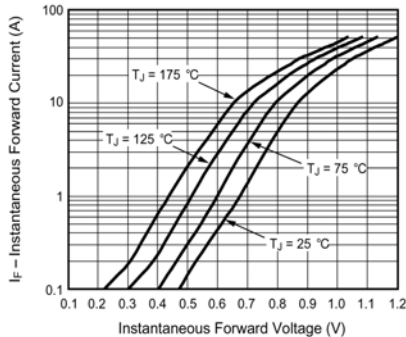

Figure 3. Typical Instantaneous Forward Characteristics Per Leg

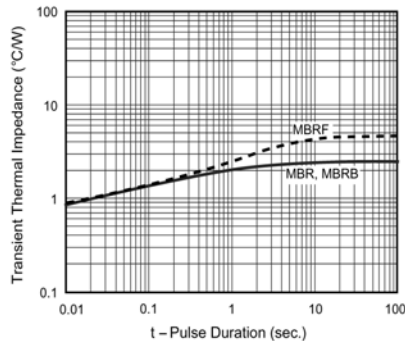

Figure 6. Typical Transient Thermal Impedance Per Leg