

30 AMPERES SCHOTTKY BARRIER RECTIFIERS

Reverse Voltage 150V

Forward Current 30 A

FEATURES

- High current capability
- Low forward voltage drop
- Low power loss, high efficiency
- High surge capability
- High temperature soldering guaranteed
- Mounting position: any

Mechanical data

- Case: TO-220F
- Approx. Weight: 2.1g (0.07oz)
- Terminals: Lead solderable per MIL-STD-202, Method 208

MAXIMUM RATINGS AND ELECTRICAL CHARACTERISTICS

Ratings at 25°C ambient temperature unless otherwise specified

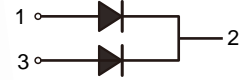
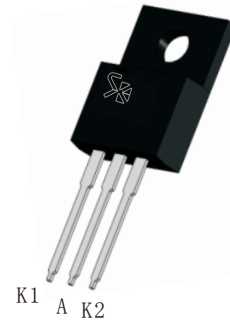

TO-220F

Parameter	Symbol	Spec. Limit			Unit
		Min.	Typ.	Max.	
Max. Repetitive Peak Reverse Voltage @0.5mA	V _{RRM}	150			V
Max. Average Forward Rectified Current Per diode Per device	I _{F(AV)}			15 30	A
Forward Voltage Drop Per diode	@ I _F =3A @ I _F =10A V _F		0.58 0.80	0.62	V
Max. Reverse Current at V _{RRM} @150V	I _R		20	50	μA
Operating Temperature Range	T _J	-55		+150	°C
Storage Temperature Range	T _{STG}	-55		+150	°C

Fig.1 TYPICAL FORWARD CURRENT DERATING CURVE

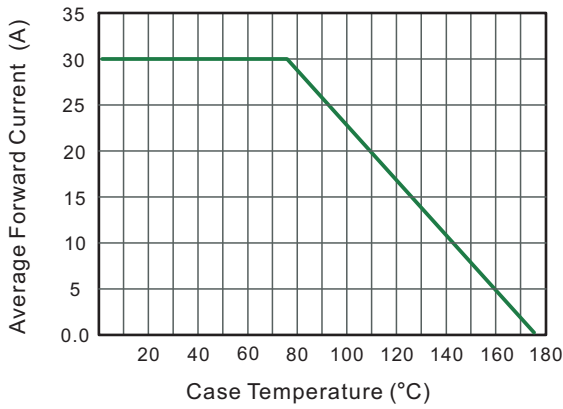

Fig.2 Typical Reverse Characteristics

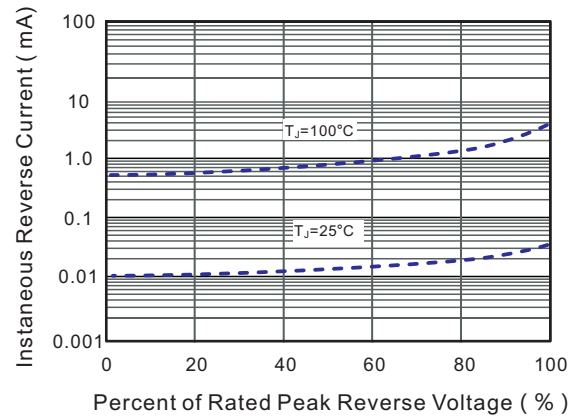

Fig.3 Typical Forward Characteristic

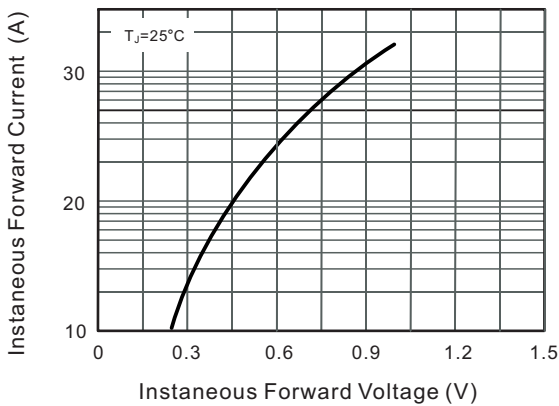

Fig.4 Typical Junction Capacitance

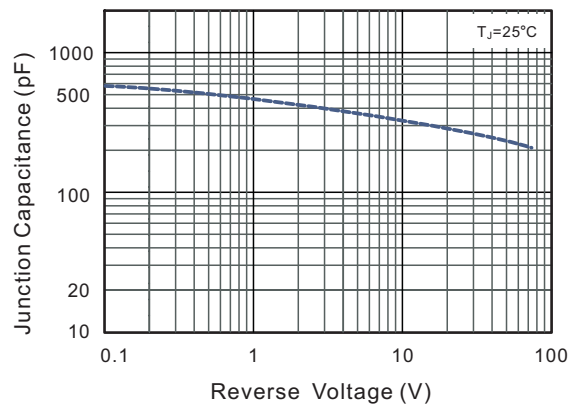

Fig.5 Maximum Non-Repetitive Peak Forward Surge Current

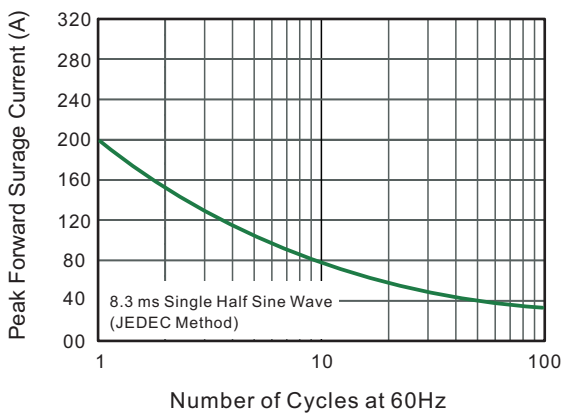
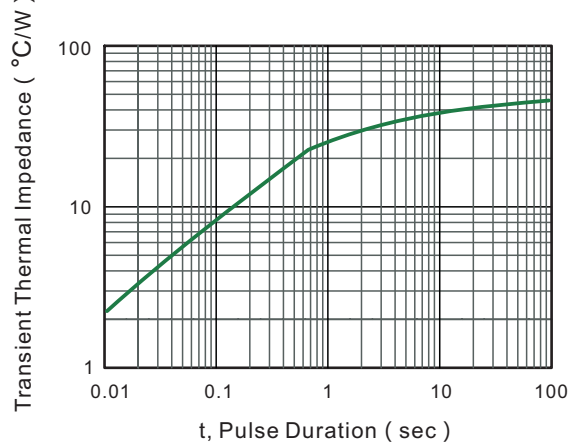

Fig.6 Typical Transient Thermal Impedance



PACKAGE OUTLINE

Plastic surface mounted package; 2 leads

TO-220F

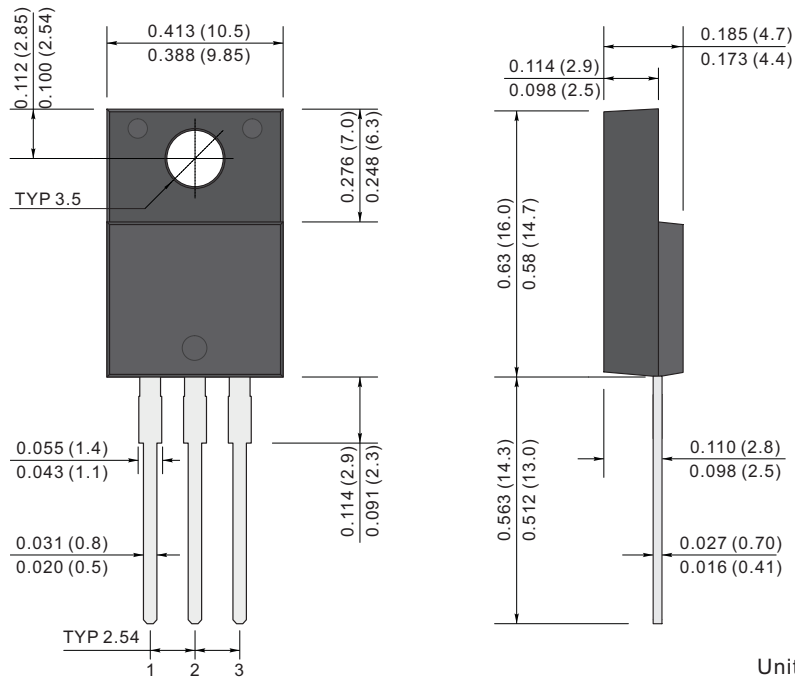

Unit: inch (mm)