

■ Features

- Low power loss, high efficiency.
- High current capability, low forward voltage drop.
- High surge capability.
- Guardring for overvoltage protection.
- Ultra high-speed switching.
- Silicon epitaxial planar chip, metal silicon junction.
- Suffix "G" indicates Halogen-free part, ex. MBRF3040CTG.
- Lead-free parts meet environmental standards of MIL-STD-19500 /228

■ Mechanical data

- Epoxy : UL94-V0 rated flame retardant.
- Case : JEDEC ITO-220AB molded plastic body over passivated chip.
- Lead : Axial leads, solderable per MIL-STD-202, Method 208 guaranteed.
- Polarity: Color band denotes cathode end.
- Mounting Position : Any.
- Weight : Approximated 2.25 gram.

■ Maximum ratings and electrical characteristics

Rating at 25°C ambient temperature unless otherwise specified. Single phase, half wave, 60Hz, resistive or inductive load. For capacitive load, derate current by 20%.

■ Outline

ITO-220AB

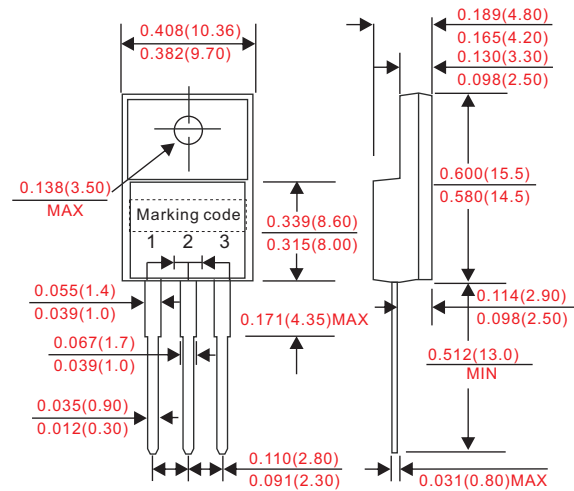

Dimensions in inches and (millimeters)

Parameter	Conditions	Symbol	MIN.	TYP.	MAX.	UNIT
Forward rectified current	See Fig.1	I_O			30	A
Forward surge current	8.3ms single half sine-wave superimposed on rate load (JEDEC method)	I_{FSM}			200	A
Reverse current	$V_R = V_{RRM}$ $T_A = 25^\circ\text{C}$	I_R			0.1	mA
	$V_R = V_{RRM}$ $T_A = 125^\circ\text{C}$				10	
Diode junction capacitance	f=1MHz and applied 4V DC reverse voltage	C_J		150		pF
Thermal resistance	Junction to ambient	$R_{\theta JA}$		30		°C/W
Storage temperature		T_{STG}	-55		+175	°C

Symbol	Marking code	Max. repetitive peak reverse voltage V_{RRM} (V)	Max. RMS voltage V_{RMS} (V)	Max. DC blocking voltage V_R (V)	Max. forward voltage @15A, $T_A = 25^\circ\text{C}$ V_F (V)	Max. forward voltage @15A, $T_A = 125^\circ\text{C}$ V_F (V)	Operating temperature T_J (°C)
MBRF3040CT	MBRF3040CT	40	28	40	0.70	0.57	-55 ~ +150
MBRF3045CT	MBRF3045CT	45	31.5	45			
MBRF3060CT	MBRF3060CT	60	42	60	0.79	0.70	
MBRF3065CT	MBRF3065CT	65	45.5	65			
MBRF30100CT	MBRF30100CT	100	70	100	0.81	0.71	-55 ~ +175
MBRF30150CT	MBRF30150CT	150	105	150	0.87	0.77	
MBRF30200CT	MBRF30200CT	200	140	200	0.90	0.80	

■ Rating and characteristic curves

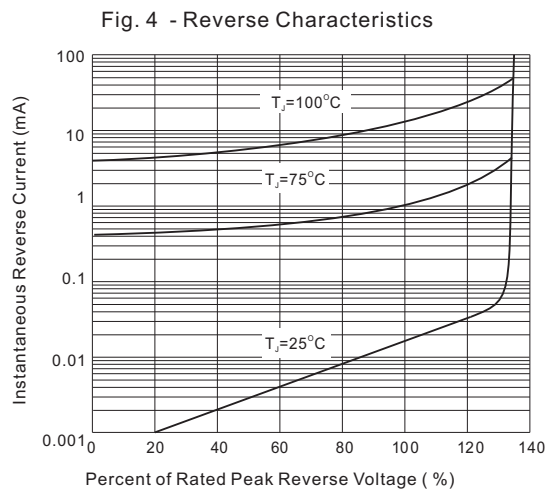
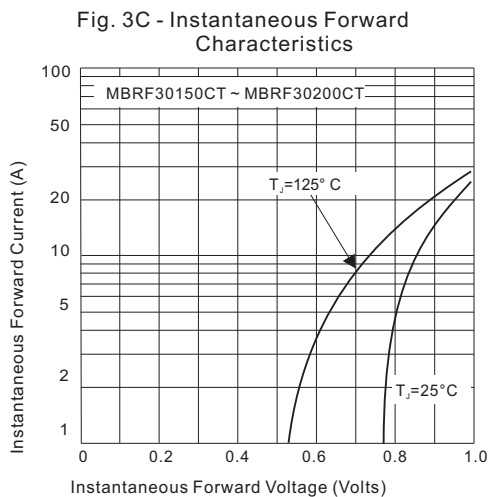
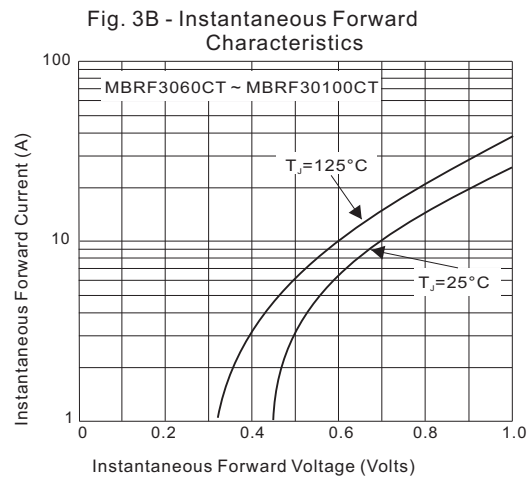
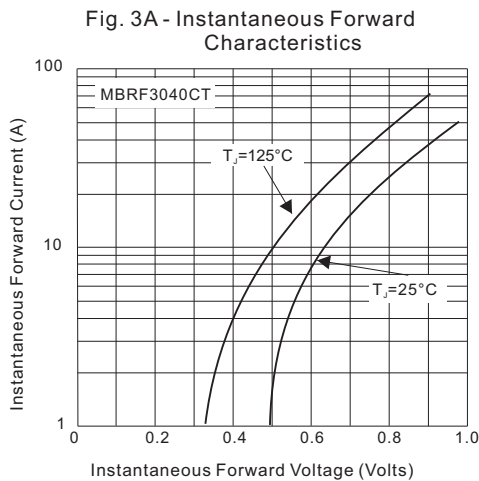
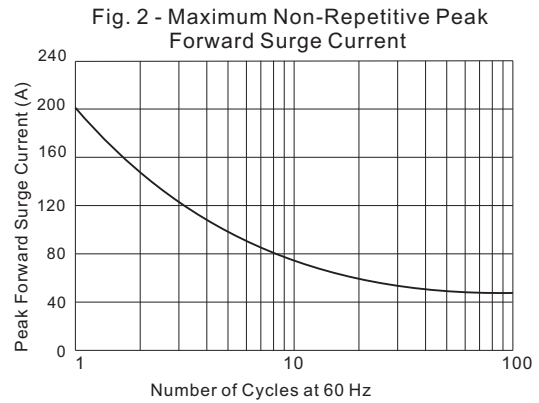
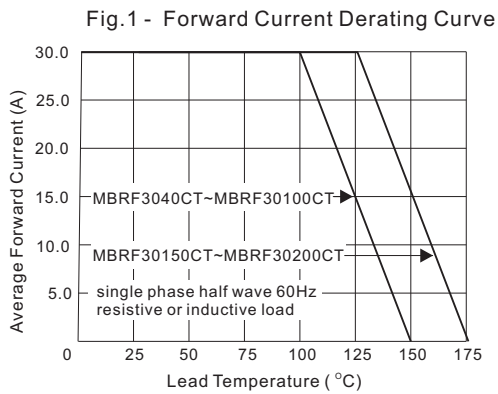

- CITC reserves the right to make changes to this document and its products and specifications at any time without notice.
- Customers should obtain and confirm the latest product information and specifications before final design, purchase or use.
- CITC makes no warranty, representation or guarantee regarding the suitability of its products for any particular purpose, nor does CITC assume any liability for application assistance or customer product design.
- CITC does not warrant or accept any liability with products which are purchased or used for any unintended or unauthorized application.
- No license is granted by implication or otherwise under any intellectual property rights of CITC.
- CITC products are not authorized for use as critical components in life support devices or systems without express written approval of CITC.