

MC1413, B MC1416, B

High Voltage, High Current Darlington Transistor Arrays

The seven NPN Darlington connected transistors in these arrays are well suited for driving lamps, relays, or printer hammers in a variety of industrial and consumer applications. Their high breakdown voltage and internal suppression diodes insure freedom from problems associated with inductive loads. Peak inrush currents to 500 mA permit them to drive incandescent lamps.

The MC1413, B with a 2.7 k Ω series input resistor is well suited for systems utilizing a 5.0 V TTL or CMOS Logic. The MC1416, B uses a series 10.5 k Ω resistor and is useful in 8.0 to 18 V MOS systems.

PERIPHERAL DRIVER ARRAYS

SEMICONDUCTOR TECHNICAL DATA

ORDERING INFORMATION

Plastic DIP	SOIC	Operating Temperature Range
MC1413P (ULN2003A) MC1416P (ULN2004A)	MC1413D MC1416D	$T_A = -20^\circ \text{ to } +85^\circ \text{C}$
MC1413BP MC1416BP	MC1413BD MC1416BD	$T_A = -40^\circ \text{ to } +85^\circ \text{C}$

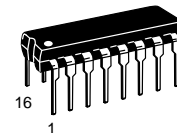

P SUFFIX
PLASTIC PACKAGE
CASE 648

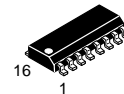

D SUFFIX
PLASTIC PACKAGE
CASE 751B
(SO-16)

Representative Schematic Diagrams

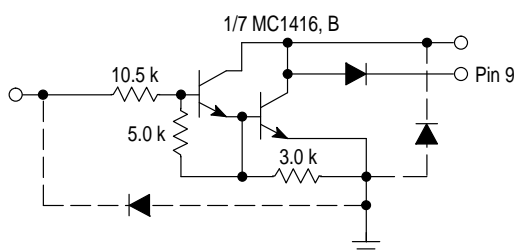
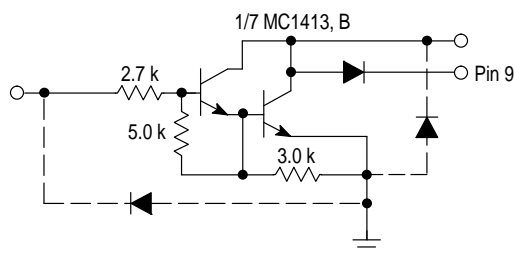

PIN CONNECTIONS

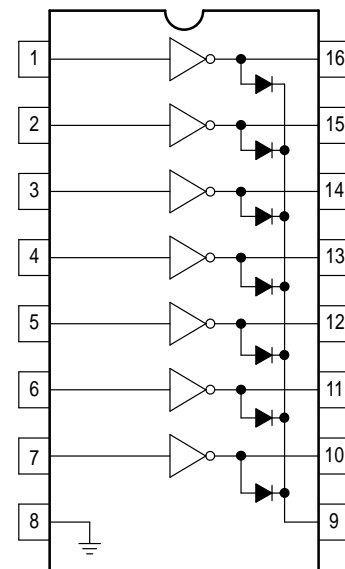

(Top View)

MC1413, B MC1416, B

MAXIMUM RATINGS ($T_A = 25^\circ\text{C}$, and rating apply to any one device in the package, unless otherwise noted.)

Rating	Symbol	Value	Unit
Output Voltage	V_O	50	V
Input Voltage	V_I	30	V
Collector Current – Continuous	I_C	500	mA
Base Current – Continuous	I_B	25	mA
Operating Ambient Temperature Range MC1413–16 MC1413B–16B	T_A	–20 to +85 –40 to +85	$^\circ\text{C}$
Storage Temperature Range	T_{stg}	–55 to +150	$^\circ\text{C}$
Junction Temperature	T_J	150	$^\circ\text{C}$
Thermal Resistance, Junction–to–Ambient Case 648, P Suffix Case 751B, D Suffix	θ_{JA}	67 100	$^\circ\text{C}/\text{W}$

NOTE: ESD data available upon request.

ELECTRICAL CHARACTERISTICS ($T_A = 25^\circ\text{C}$, unless otherwise noted)

Characteristic	Symbol	Min	Typ	Max	Unit
Output Leakage Current ($V_O = 50\text{ V}$, $T_A = +85^\circ\text{C}$) ($V_O = 50\text{ V}$, $T_A = +25^\circ\text{C}$) ($V_O = 50\text{ V}$, $T_A = +85^\circ\text{C}$, $V_I = 1.0\text{ V}$)	I_{CEX} All Types All Types MC1416, B	– – –	– – –	100 50 500	μA
Collector–Emitter Saturation Voltage ($I_C = 350\text{ mA}$, $I_B = 500\text{ }\mu\text{A}$) ($I_C = 200\text{ mA}$, $I_B = 350\text{ }\mu\text{A}$) ($I_C = 100\text{ mA}$, $I_B = 250\text{ }\mu\text{A}$)	$V_{\text{CE(sat)}}$ All Types All Types All Types	– – –	1.1 0.95 0.85	1.6 1.3 1.1	V
Input Current – On Condition ($V_I = 3.85\text{ V}$) ($V_I = 5.0\text{ V}$) ($V_I = 12\text{ V}$)	$I_{\text{I(on)}}$ MC1413, B MC1416, B MC1416, B	– – –	0.93 0.35 1.0	1.35 0.5 1.45	mA
Input Voltage – On Condition ($V_{\text{CE}} = 2.0\text{ V}$, $I_C = 200\text{ mA}$) ($V_{\text{CE}} = 2.0\text{ V}$, $I_C = 250\text{ mA}$) ($V_{\text{CE}} = 2.0\text{ V}$, $I_C = 300\text{ mA}$) ($V_{\text{CE}} = 2.0\text{ V}$, $I_C = 125\text{ mA}$) ($V_{\text{CE}} = 2.0\text{ V}$, $I_C = 200\text{ mA}$) ($V_{\text{CE}} = 2.0\text{ V}$, $I_C = 275\text{ mA}$) ($V_{\text{CE}} = 2.0\text{ V}$, $I_C = 350\text{ mA}$)	$V_{\text{I(on)}}$ MC1413, B MC1413, B MC1413, B MC1416, B MC1416, B MC1416, B MC1416, B	– – – – – – –	– – – – – – –	2.4 2.7 3.0 5.0 6.0 7.0 8.0	V
Input Current – Off Condition ($I_C = 500\text{ }\mu\text{A}$, $T_A = 85^\circ\text{C}$)	All Types $I_{\text{I(off)}}$	50	100	–	μA
DC Current Gain ($V_{\text{CE}} = 2.0\text{ V}$, $I_C = 350\text{ mA}$)	h_{FE}	1000	–	–	–
Input Capacitance	C_I	–	15	30	pF
Turn–On Delay Time (50% E_I to 50% E_O)	t_{on}	–	0.25	1.0	μs
Turn–Off Delay Time (50% E_I to 50% E_O)	t_{off}	–	0.25	1.0	μs
Clamp Diode Leakage Current ($V_R = 50\text{ V}$)	I_R $T_A = +25^\circ\text{C}$ $T_A = +85^\circ\text{C}$	– –	– –	50 100	μA
Clamp Diode Forward Voltage ($I_F = 350\text{ mA}$)	V_F	–	1.5	2.0	V

MC1413, B MC1416, B

TYPICAL PERFORMANCE CURVES – $T_A = 25^\circ\text{C}$

Figure 1. Output Current versus Input Voltage

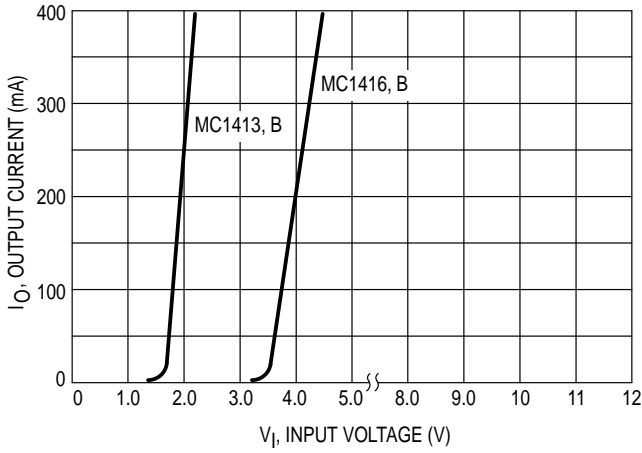

Figure 2. Output Current versus Input Current

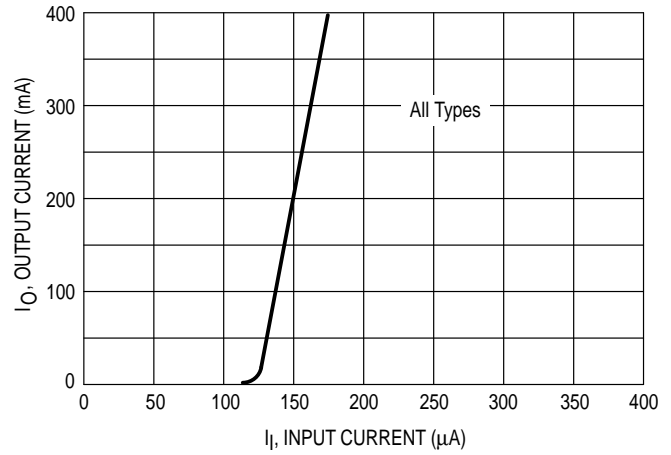

Figure 3. Typical Output Characteristics

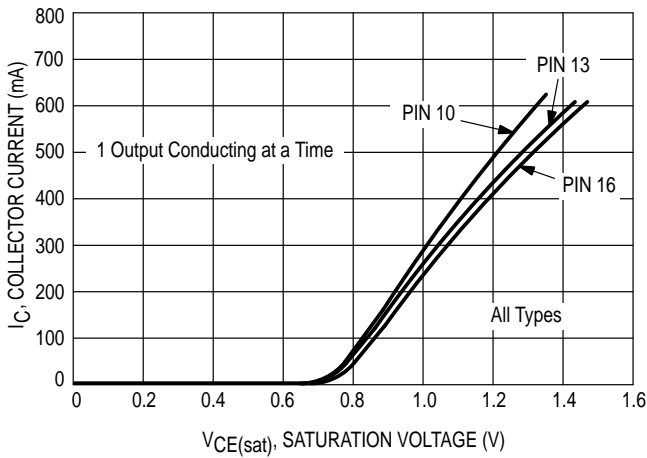

Figure 4. Input Characteristics – MC1413, B

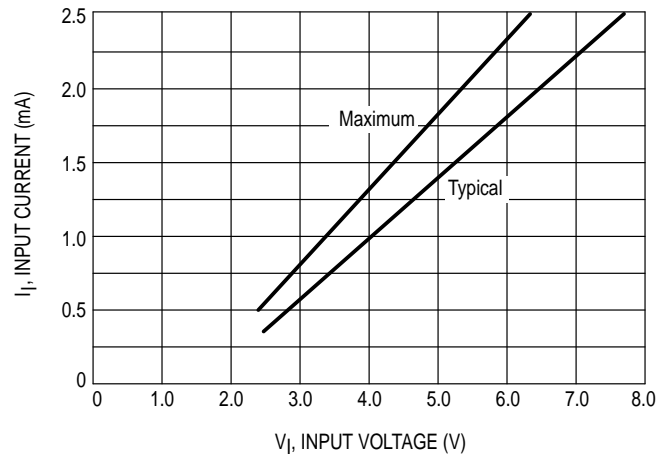

Figure 5. Input Characteristics – MC1416, B

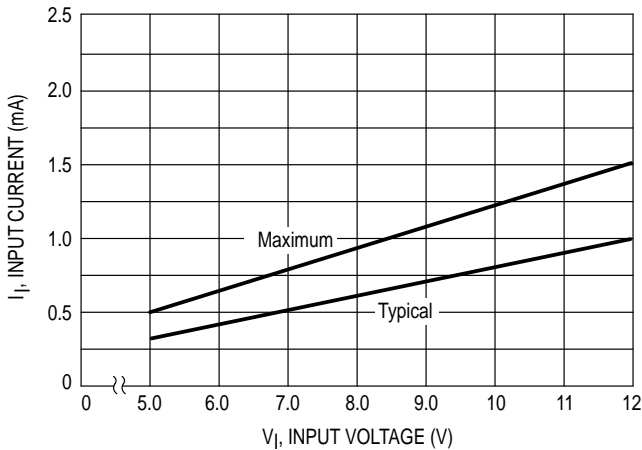
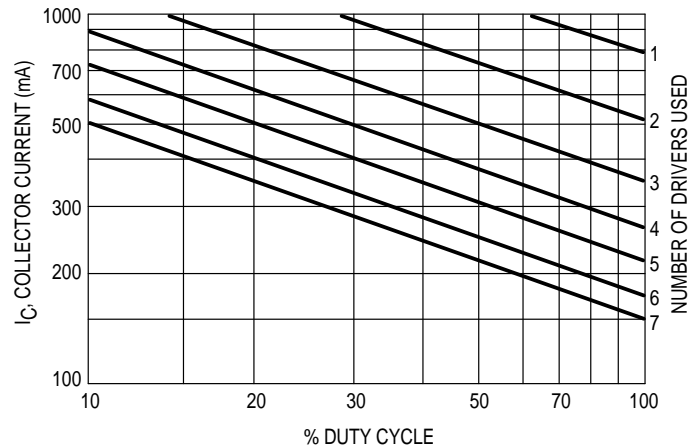

Figure 6. Maximum Collector Current versus Duty Cycle (and Number of Drivers in Use)



MC1413, B MC1416, B

OUTLINE DIMENSIONS

P SUFFIX PLASTIC PACKAGE CASE 648-08 ISSUE R

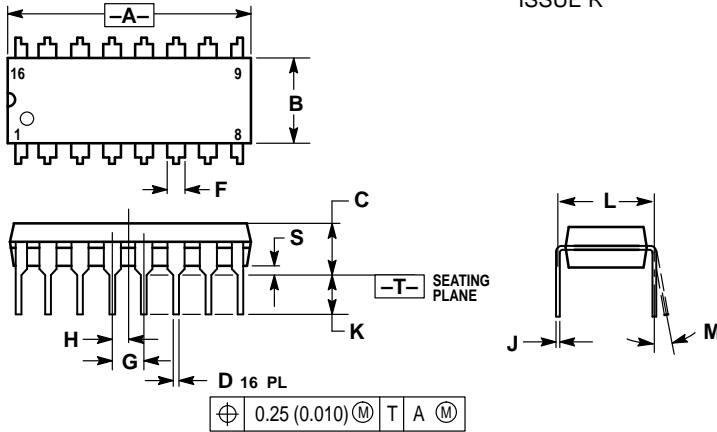

- NOTES:
1. DIMENSIONING AND TOLERANCING PER ANSI Y14.5M, 1982.
 2. CONTROLLING DIMENSION: INCH.
 3. DIMENSION L TO CENTER OF LEADS WHEN FORMED PARALLEL.
 4. DIMENSION B DOES NOT INCLUDE MOLD FLASH.
 5. ROUNDED CORNERS OPTIONAL.

DIM	INCHES		MILLIMETERS	
	MIN	MAX	MIN	MAX
A	0.740	0.770	18.80	19.55
B	0.250	0.270	6.35	6.85
C	0.145	0.175	3.69	4.44
D	0.015	0.021	0.39	0.53
F	0.040	0.70	1.02	1.77
G	0.100 BSC		2.54 BSC	
H	0.050 BSC		1.27 BSC	
J	0.008	0.015	0.21	0.38
K	0.110	0.130	2.80	3.30
L	0.295	0.305	7.50	7.74
M	0°	10°	0°	10°
S	0.020	0.040	0.51	1.01

D SUFFIX PLASTIC PACKAGE CASE 751B-05 (SO-16) ISSUE J

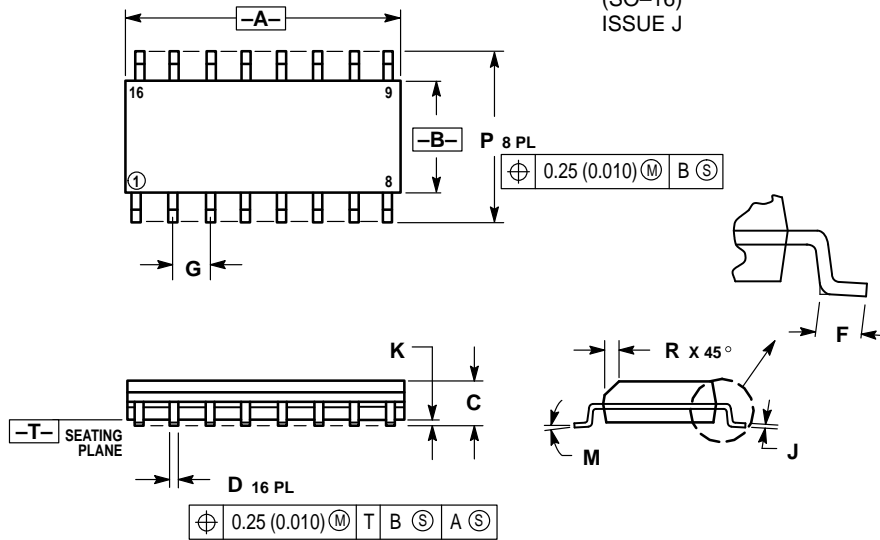

- NOTES:
1. DIMENSIONING AND TOLERANCING PER ANSI Y14.5M, 1982.
 2. CONTROLLING DIMENSION: MILLIMETER.
 3. DIMENSIONS A AND B DO NOT INCLUDE MOLD PROTRUSION.
 4. MAXIMUM MOLD PROTRUSION 0.15 (0.006) PER SIDE.
 5. DIMENSION D DOES NOT INCLUDE DAMBAR PROTRUSION. ALLOWABLE DAMBAR PROTRUSION SHALL BE 0.127 (0.005) TOTAL IN EXCESS OF THE D DIMENSION AT MAXIMUM MATERIAL CONDITION.

DIM	MILLIMETERS		INCHES	
	MIN	MAX	MIN	MAX
A	9.80	10.00	0.386	0.393
B	3.80	4.00	0.150	0.157
C	1.35	1.75	0.054	0.068
D	0.35	0.49	0.014	0.019
F	0.40	1.25	0.016	0.049
G	1.27 BSC		0.050 BSC	
J	0.19	0.25	0.008	0.009
K	0.10	0.25	0.004	0.009
M	0°	7°	0°	7°
P	5.80	6.20	0.229	0.244
R	0.25	0.50	0.010	0.019

Motorola reserves the right to make changes without further notice to any products herein. Motorola makes no warranty, representation or guarantee regarding the suitability of its products for any particular purpose, nor does Motorola assume any liability arising out of the application or use of any product or circuit, and specifically disclaims any and all liability, including without limitation consequential or incidental damages. "Typical" parameters which may be provided in Motorola data sheets and/or specifications can and do vary in different applications and actual performance may vary over time. All operating parameters, including "Typicals" must be validated for each customer application by customer's technical experts. Motorola does not convey any license under its patent rights nor the rights of others. Motorola products are not designed, intended, or authorized for use as components in systems intended for surgical implant into the body, or other applications intended to support or sustain life, or for any other application in which the failure of the Motorola product could create a situation where personal injury or death may occur. Should Buyer purchase or use Motorola products for any such unintended or unauthorized application, Buyer shall indemnify and hold Motorola and its officers, employees, subsidiaries, affiliates, and distributors harmless against all claims, costs, damages, and expenses, and reasonable attorney fees arising out of, directly or indirectly, any claim of personal injury or death associated with such unintended or unauthorized use, even if such claim alleges that Motorola was negligent regarding the design or manufacture of the part. Motorola and are registered trademarks of Motorola, Inc. Motorola, Inc. is an Equal Opportunity/Affirmative Action Employer.

How to reach us:

USA/EUROPE/Locations Not Listed: Motorola Literature Distribution;
P.O. Box 20912; Phoenix, Arizona 85036. 1-800-441-2447 or 602-303-5454

JAPAN: Nippon Motorola Ltd.; Tatsumi-SPD-JLDC, 6F Seibu-Butsuryu-Center,
3-14-2 Tatsumi Koto-Ku, Tokyo 135, Japan. 03-81-3521-8315

MFAX: RMFAX0@email.sps.mot.com – TOUCHTONE 602-244-6609
INTERNET: http://Design-NET.com

ASIA/PACIFIC: Motorola Semiconductors H.K. Ltd.; 8B Tai Ping Industrial Park,
51 Ting Kok Road, Tai Po, N.T., Hong Kong. 852-26629298



This datasheet has been downloaded from:

www.DatasheetCatalog.com

Datasheets for electronic components.