

## Addendum

HC908LJ12AD/D  
Rev. 0, 6/2003

Addendum to  
MC68HC908LJ12  
Technical Data

This addendum provides information to the following MCU devices:

- **MC68HLC908LJ12** (see page 1)
- **MC68HC08LJ12** (see page 9)

The entire *MC68HC908LJ12 Technical Data*, Rev. 2 (Motorola document number MC68HC908LJ12/D) applies to these two devices, with exceptions outlined in this addendum.

Amendments to *MC68HC908LJ12/D*, Rev. 2, are documented on page 13.

---

## MC68HLC908LJ12

The MC68HLC908LJ12 is a low-voltage version of the MC68HC908LJ12, with an operating voltage range of 2.4 to 3.3V.

### FLASH Memory

The FLASH memory can be read at operating voltages from 2.4 to 3.3V. Program or erase operations require a minimum operating voltage of 2.7V.

### Low-Voltage Inhibit (LVI)

The LVI module is not designed for the MC68HLC908LJ12. After an MCU reset, the LVI module is disabled (LVIPWRD = 1 in CONFIG1). The LVIPWRD bit should be left as logic 1 (the default setting).

### Electrical Specifications

Electrical specifications for the MC68HLC908LJ12 device are given in the following tables.



Functional Operating Range

Table 1. Operating Range

Characteristic	Symbol	Value		Unit
Operating temperature range	$T_A$	- 40 to +85		°C
Operating voltage range	$V_{DD}$	2.4 to 2.7	2.7 to 3.3	V
Maximum internal operating frequency	$f_{OP}$	2	4	MHz
Operating voltage for FLASH memory program and erase operations	$V_{DD}$	2.7 to 3.3		V

DC Electrical Characteristics

Table 2. DC Electrical Characteristics (2.4 to 2.7V)

Characteristic <sup>(1)</sup>	Symbol	Min	Typ <sup>(2)</sup>	Max	Unit
Output high voltage ( $I_{LOAD} = -1.0$ mA) All ports	$V_{OH}$	$V_{DD}-0.4$	—	—	V
Output low voltage ( $I_{LOAD} = 0.8$ mA) All ports ( $I_{LOAD} = 4.0$ mA) PTB2-PTB5 ( $I_{LOAD} = 10.0$ mA) PTB0/TxD-PTB1	$V_{OL}$	—	—	0.4	V
Input high voltage All ports, $\overline{RST}$ , $\overline{IRQ}$ , OSC1	$V_{IH}$	$0.7 \times V_{DD}$	—	$V_{DD}$	V
Input low voltage All ports, $\overline{RST}$ , $\overline{IRQ}$ , OSC1	$V_{IL}$	$V_{SS}$	—	$0.3 \times V_{DD}$	V
$V_{DD}$ supply current					
Run <sup>(3)</sup> , $f_{OP} = 2$ MHz with all modules on	$I_{DD}$	—	—	5.2	mA
with ADC on		—	—	3.8	mA
with ADC off		—	—	2.8	mA
Wait <sup>(4)</sup> , $f_{OP} = 2$ MHz (all modules off)		—	—	2.3	mA
Stop, $f_{OP} = 8$ kHz <sup>(5)</sup>		—	—	—	—
25°C (with OSC, RTC, LCD <sup>(6)</sup> , LVI on)		—	—	200	µA
25°C (with OSC, RTC, LCD <sup>(6)</sup> on)		—	—	27	µA
25°C (with OSC, RTC on)		—	—	15	µA
25°C (all modules off)	—	—	1	µA	
Digital I/O ports Hi-Z leakage current All ports, $\overline{RST}$	$I_{IL}$	—	—	± 10	µA

Table 2. DC Electrical Characteristics (2.4 to 2.7V) (Continued)

Characteristic <sup>(1)</sup>	Symbol	Min	Typ <sup>(2)</sup>	Max	Unit
Input current $\overline{\text{IRQ}}$	$I_{\text{IN}}$	—	—	$\pm 1$	$\mu\text{A}$
Capacitance Ports (as input or output)	$C_{\text{OUT}}$ $C_{\text{IN}}$	— —	— —	12 8	pF
POR re-arm voltage <sup>(7)</sup>	$V_{\text{POR}}$	0	—	100	mV
POR rise-time ramp rate <sup>(8)</sup>	$R_{\text{POR}}$	0.02	—	—	V/ms
Monitor mode entry voltage (at $\overline{\text{IRQ}}$ pin)	$V_{\text{HI}}$	$1.5 \times V_{\text{DD}}$	—	$2 \times V_{\text{DD}}$	V
Pullup resistors <sup>(9)</sup> PTA0–PTA3, PTD4–PTD7 configured as KBI0–KBI7 $\overline{\text{RST}}$ , $\overline{\text{IRQ}}$	$R_{\text{PU1}}$ $R_{\text{PU2}}$	— —	25 27	— —	k $\Omega$ k $\Omega$

- $V_{\text{DD}} = 2.4$  to  $2.7$  Vdc,  $V_{\text{SS}} = 0$  Vdc,  $T_A = T_L$  to  $T_H$ , unless otherwise noted.
- Typical values reflect average measurements at midpoint of voltage range,  $25^\circ\text{C}$  only.
- Run (operating)  $I_{\text{DD}}$  measured using external square wave clock source. All inputs 0.2 V from rail. No dc loads. Less than 100 pF on all outputs.  $C_L = 20$  pF on OSC2. All ports configured as inputs. OSC2 capacitance linearly affects run  $I_{\text{DD}}$ .
- Wait  $I_{\text{DD}}$  measured using external square wave clock source. All inputs 0.2 V from rail. No dc loads. Less than 100 pF on all outputs.  $C_L = 20$  pF on OSC2. All ports configured as inputs. OSC2 capacitance linearly affects wait  $I_{\text{DD}}$ .
- The 8kHz clock is from a 32kHz clock input at OSC1, for the driving the RTC.
- LCD driver configured for low current mode.
- Maximum is highest voltage that POR is guaranteed.
- If minimum  $V_{\text{DD}}$  is not reached before the internal POR reset is released,  $\overline{\text{RST}}$  must be driven low externally until minimum  $V_{\text{DD}}$  is reached.
- $R_{\text{PU1}}$  and  $R_{\text{PU2}}$  are measured at  $V_{\text{DD}} = 2.6\text{V}$ .

Table 3. DC Electrical Characteristics (2.7 to 3.3V)

Characteristic <sup>(1)</sup>	Symbol	Min	Typ <sup>(2)</sup>	Max	Unit
Output high voltage ( $I_{\text{LOAD}} = -1.0$ mA) All ports	$V_{\text{OH}}$	$V_{\text{DD}} - 0.4$	—	—	V
Output low voltage ( $I_{\text{LOAD}} = 0.8$ mA) All ports ( $I_{\text{LOAD}} = 4.0$ mA) PTB2–PTB5 ( $I_{\text{LOAD}} = 10.0$ mA) PTB0/TxD–PTB1	$V_{\text{OL}}$	—	—	0.4	V
Input high voltage All ports, $\overline{\text{RST}}$ , $\overline{\text{IRQ}}$ , OSC1	$V_{\text{IH}}$	$0.7 \times V_{\text{DD}}$	—	$V_{\text{DD}}$	V
Input low voltage All ports, $\overline{\text{RST}}$ , $\overline{\text{IRQ}}$ , OSC1	$V_{\text{IL}}$	$V_{\text{SS}}$	—	$0.3 \times V_{\text{DD}}$	V

Table 3. DC Electrical Characteristics (2.7 to 3.3V) (Continued)

Characteristic <sup>(1)</sup>	Symbol	Min	Typ <sup>(2)</sup>	Max	Unit
V <sub>DD</sub> supply current					
Run <sup>(3)</sup> , f <sub>OP</sub> = 4 MHz		—	—	8	mA
with all modules on		—	—	6	mA
with ADC on		—	—	5	mA
with ADC off		—	—	3.5	mA
Wait <sup>(4)</sup> , f <sub>OP</sub> = 4 MHz (all modules off)	I <sub>DD</sub>	—	—	3.5	mA
Stop, f <sub>OP</sub> = 8 kHz <sup>(5)</sup>					
25°C (with OSC, RTC, LCD <sup>(6)</sup> , LVI on)		—	—	280	μA
25°C (with OSC, RTC, LCD <sup>(6)</sup> on)		—	—	38	μA
25°C (with OSC, RTC on)		—	—	15	μA
25°C (all modules off)		—	—	1	μA
Digital I/O ports Hi-Z leakage current					
All ports, $\overline{RST}$	I <sub>IL</sub>	—	—	± 10	μA
Input current					
$\overline{IRQ}$	I <sub>IN</sub>	—	—	± 1	μA
Capacitance					
Ports (as input or output)	C <sub>OUT</sub> C <sub>IN</sub>	— —	— —	12 8	pF
POR re-arm voltage <sup>(7)</sup>	V <sub>POR</sub>	0	—	100	mV
POR rise-time ramp rate <sup>(8)</sup>	R <sub>POR</sub>	0.02	—	—	V/ms
Monitor mode entry voltage (at $\overline{IRQ}$ pin)	V <sub>HI</sub>	1.5 × V <sub>DD</sub>	—	2 × V <sub>DD</sub>	V
Pullup resistors <sup>(9)</sup>					
PTA0–PTA3, PTD4–PTD7 configured as KBI0–KBI7	R <sub>PU1</sub>	—	25	—	kΩ
$\overline{RST}$ , $\overline{IRQ}$	R <sub>PU2</sub>	—	27	—	kΩ

- V<sub>DD</sub> = 2.7 to 3.3 Vdc, V<sub>SS</sub> = 0 Vdc, T<sub>A</sub> = T<sub>L</sub> to T<sub>H</sub>, unless otherwise noted.
- Typical values reflect average measurements at midpoint of voltage range, 25 °C only.
- Run (operating) I<sub>DD</sub> measured using external square wave clock source. All inputs 0.2 V from rail. No dc loads. Less than 100 pF on all outputs. C<sub>L</sub> = 20 pF on OSC2. All ports configured as inputs. OSC2 capacitance linearly affects run I<sub>DD</sub>.
- Wait I<sub>DD</sub> measured using external square wave clock source. All inputs 0.2 V from rail. No dc loads. Less than 100 pF on all outputs. C<sub>L</sub> = 20 pF on OSC2. All ports configured as inputs. OSC2 capacitance linearly affects wait I<sub>DD</sub>.
- The 8kHz clock is from a 32kHz clock input at OSC1, for the driving the RTC.
- LCD driver configured for low current mode.
- Maximum is highest voltage that POR is guaranteed.
- If minimum V<sub>DD</sub> is not reached before the internal POR reset is released,  $\overline{RST}$  must be driven low externally until minimum V<sub>DD</sub> is reached.
- R<sub>PU1</sub> and R<sub>PU2</sub> are measured at V<sub>DD</sub> = 3V.

Oscillator  
Characteristics

**Table 4. Oscillator Specifications (2.4 to 2.7V)**

Characteristic	Symbol	Min	Typ	Max	Unit
Internal oscillator clock frequency	f <sub>ICLK</sub>	—	See <a href="#">Figure 1</a> .	—	Hz
External reference clock to OSC1 <sup>(1)</sup>	f <sub>OSC</sub>	dc	—	8M	Hz
Crystal reference frequency <sup>(2)</sup>	f <sub>XCLK</sub>		32.768k	4.9152M	Hz
Crystal load capacitance <sup>(3)</sup>	C <sub>L</sub>	—	—	—	
Crystal fixed capacitance	C <sub>1</sub>	—	2 × C <sub>L</sub> (25p)	—	F
Crystal tuning capacitance	C <sub>2</sub>	—	2 × C <sub>L</sub> (25p)	—	F
Feedback bias resistor	R <sub>B</sub>	—	10M	—	Ω
Series resistor <sup>(4)</sup>	R <sub>S</sub>	—	100k	—	Ω

1. No more than 10% duty cycle deviation from 50%.
2. Fundamental mode crystals only.
3. Consult crystal manufacturer's data.
4. Not Required for high frequency crystals.

**Table 5. Oscillator Specifications (2.7 to 3.3V)**

Characteristic	Symbol	Min	Typ	Max	Unit
Internal oscillator clock frequency	f <sub>ICLK</sub>	—	See <a href="#">Figure 1</a> .	—	Hz
External reference clock to OSC1 <sup>(1)</sup>	f <sub>OSC</sub>	dc	—	16M	Hz
Crystal reference frequency <sup>(2)</sup>	f <sub>XCLK</sub>		32.768k	4.9152M	Hz
Crystal load capacitance <sup>(3)</sup>	C <sub>L</sub>	—	—	—	
Crystal fixed capacitance	C <sub>1</sub>	—	2 × C <sub>L</sub> (25p)	—	F
Crystal tuning capacitance	C <sub>2</sub>	—	2 × C <sub>L</sub> (25p)	—	F
Feedback bias resistor	R <sub>B</sub>	—	10M	—	Ω
Series resistor <sup>(4)</sup>	R <sub>S</sub>	—	100k	—	Ω

1. No more than 10% duty cycle deviation from 50%.
2. Fundamental mode crystals only.
3. Consult crystal manufacturer's data.
4. Not Required for high frequency crystals.

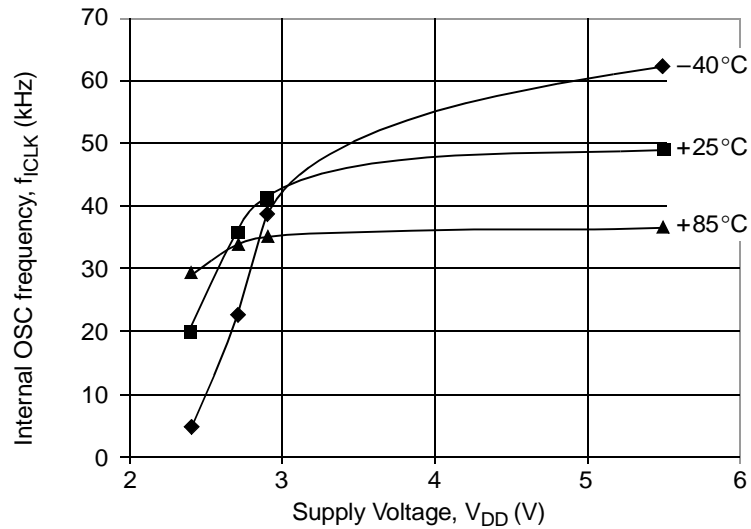
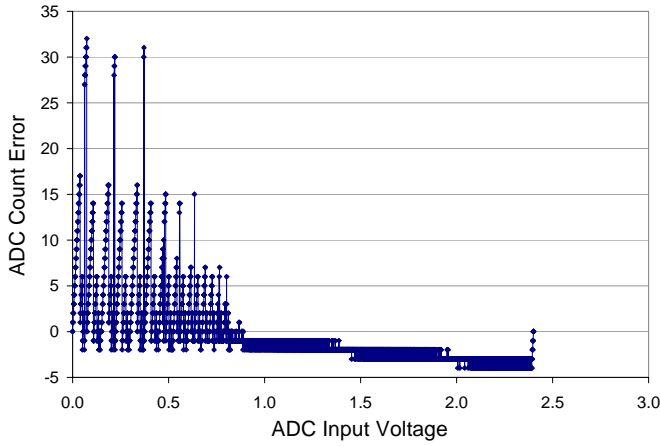

Figure 1. Typical Internal Oscillator Frequency

ADC Electrical Characteristics

Table 6. ADC Electrical Characteristics (2.4 to 3.3V)

Characteristic	Symbol	Min	Max	Unit	Notes
Supply voltage	V <sub>DDA</sub>	2.4	3.3	V	
Input range	V <sub>ADIN</sub>	0	V <sub>DDA</sub>	V	V <sub>ADIN</sub> ≤ V <sub>DDA</sub>
Resolution	B <sub>AD</sub>	10	10	bits	1,024 counts
Absolute accuracy	A <sub>AD</sub>	See Figure 2 and Figure 3.			Includes quantization. ±1 ADC count = ±0.5 LSB
ADC internal clock	f <sub>ADIC</sub>	32 k	2 M	Hz	t <sub>ADIC</sub> = 1/f <sub>ADIC</sub>
Conversion range	R <sub>AD</sub>	V <sub>REFL</sub>	V <sub>REFH</sub>	V	
ADC voltage reference high	V <sub>REFH</sub>	—	V <sub>DDA</sub> + 0.1	V	
ADC voltage reference low	V <sub>REFL</sub>	V <sub>SSA</sub> - 0.1	—	V	V <sub>SSA</sub> is tied to V <sub>SS</sub> internally.
Conversion time	t <sub>ADC</sub>	16	17	t <sub>ADIC</sub> cycles	
Sample time	t <sub>ADS</sub>	5	—	t <sub>ADIC</sub> cycles	
Monotonically	M <sub>AD</sub>	Guaranteed			
Zero input reading	Z <sub>ADI</sub>	000	001	HEX	V <sub>ADIN</sub> = V <sub>REFL</sub>
Full-scale reading	F <sub>ADI</sub>	3FC	3FF	HEX	V <sub>ADIN</sub> = V <sub>REFH</sub>
Input capacitance	C <sub>ADI</sub>	—	20	pF	Not tested.
Input impedance	R <sub>ADI</sub>	20M	—	Ω	Measured at 5V
V <sub>REFH</sub> /V <sub>REFL</sub>	I <sub>VREF</sub>	—	1.6	mA	Not tested.



(a)  $V_{DD} = 2.4V$  at  $-40^{\circ}C$

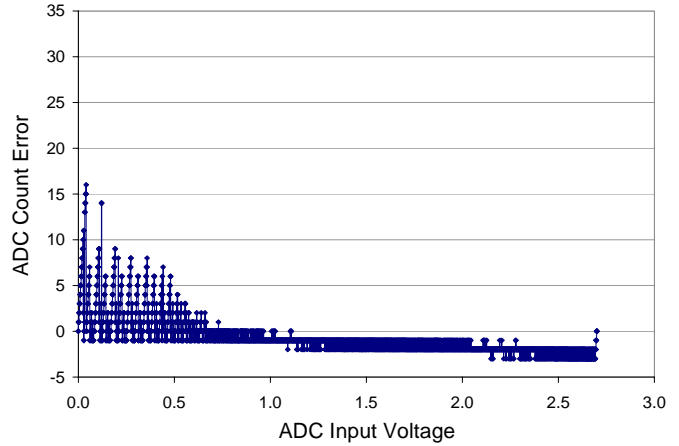

(d)  $V_{DD} = 2.7V$  at  $-40^{\circ}C$

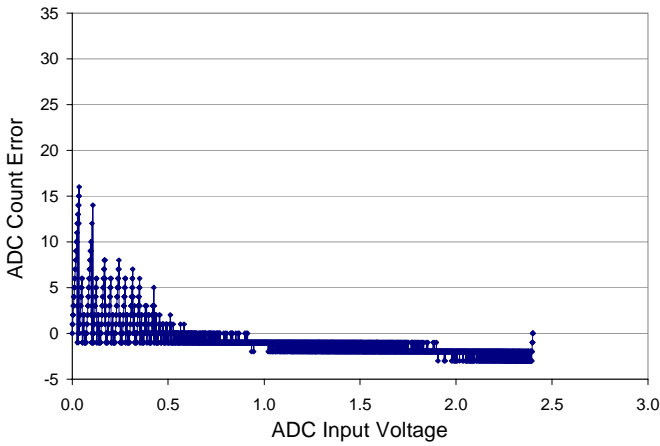

(b)  $V_{DD} = 2.4V$  at  $25^{\circ}C$

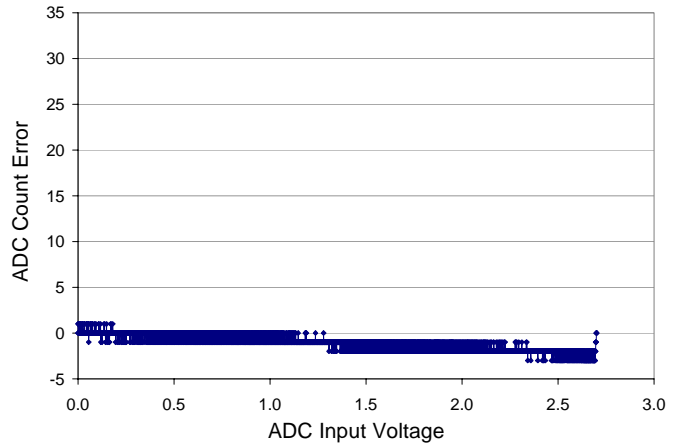

(e)  $V_{DD} = 2.7V$  at  $25^{\circ}C$

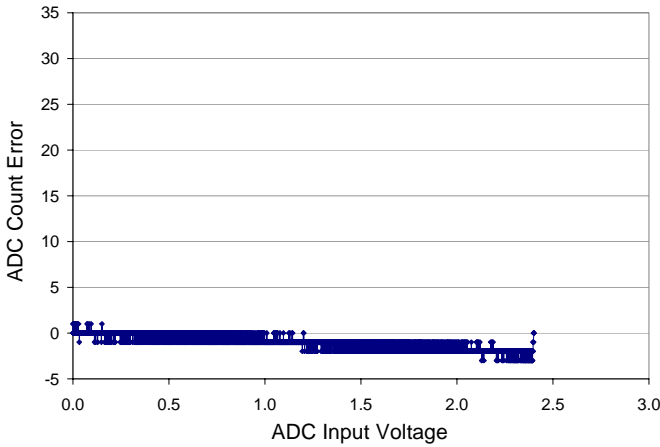

(c)  $V_{DD} = 2.4V$  at  $85^{\circ}C$

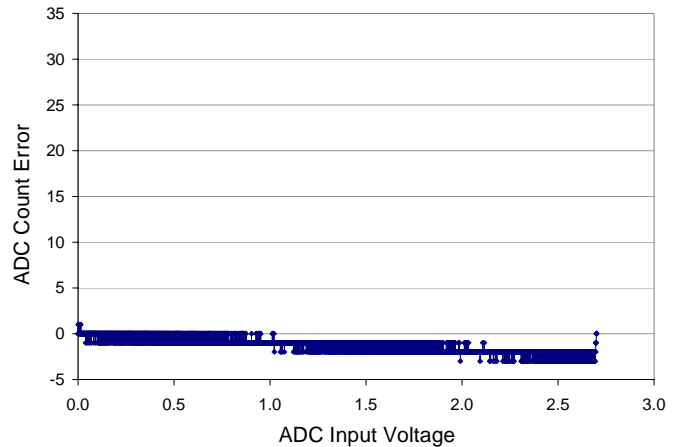

(f)  $V_{DD} = 2.7V$  at  $85^{\circ}C$

Note: ADC performance increases with increase in operating voltage and temperature.

Figure 2. Typical ADC Accuracy (2.4V and 2.7V)

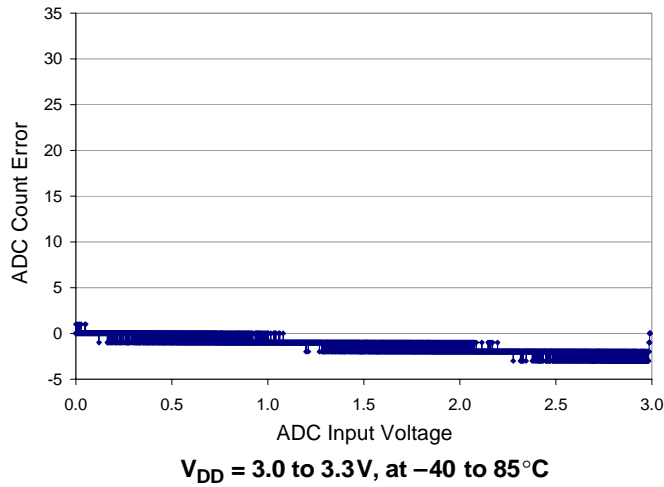

Figure 3. Typical ADC Accuracy (3V and 3.3V)

Memory  
Characteristics

At an operating voltage of less than 2.7 V, the FLASH memory can only be read. Program and erase are achieved at an operating voltage of 2.7 to 3.3V. The program and erase parameters in the *MC68HC908LJ12 Technical Data* are for  $V_{DD} = 2.7 \text{ to } 3.3\text{V}$  only.

MC68HLC908LJ12  
Order Numbers

Table 7 shows the ordering numbers for the MC68HLC908LJ12.

Table 7. MC68HLC908LJ12 Order Numbers

MC Order Number <sup>(1)</sup>	Package	Operating Temperature Range
MC68HLC98LJ12CFB	52-pin LQFP	-40 °C to +85 °C
MC68HLC98LJ12CPB	64-pin LQFP	-40 °C to +85 °C
MC68HLC98LJ12CFU	64-pin QFP	-40 °C to +85 °C

1. The missing "0" in "908" is intentional.



**MC68HC08LJ12**

The MC68HC08LJ12 is the ROM part equivalent to the MC68HC908LJ12.

**Table 8. Summary of MC68HC08LJ12 and MC68HC908LJ12 Differences**

	MC68HC08LJ12	MC68HC908LJ12
<b>Operating voltages</b>	— 5.0V ± 10%	3.3V ± 10% 5.0V ± 10%
<b>Memory (\$C000–\$EFFF)</b>	12,288 bytes ROM	12,288 bytes FLASH
<b>User vectors (\$FFD0–\$FFFF)</b>	48 bytes ROM	48 bytes FLASH
<b>Registers at \$FE08 and \$FF09</b>	Not used; locations are reserved.	FLASH related registers. \$FE08 — FLCR \$FF09 — FLBPR
<b>Monitor ROM (\$FC00–\$FDFF and \$FE10–\$FFCF)</b>	Used for testing purposes only.	Used for testing and FLASH programming/erasing.
<b>Available packages</b>	52-pin LQFP 64-pin LQFP 64-pin QFP	52-pin LQFP 64-pin LQFP 64-pin QFP

**MCU Block Diagram** [Figure 4](#) shows the block diagram of the MC68HC08LJ12.

**Memory Map** The MC68HC08LJ128 has 12,288 bytes of user ROM from \$C000 to \$EFFF, and 48 bytes of user ROM vectors from \$FFD0 to \$FFFF. On the MC68HC908LJ12 these memory locations are FLASH memory.

[Figure 5](#) shows the memory map of the MC68HC08LJ12.

**Reserved Registers** The two registers at \$FE08 and \$FE09 are reserved locations on the MC68HC08LJ12.  
On the MC68HC908LJ12, these two locations are the FLASH control register and the FLASH block protect register respectively.

**Monitor ROM** The monitor program (monitor ROM: \$FE10–\$FFCF and \$FC00–\$FDFF) on the MC68HC08LJ12 is for device testing only.

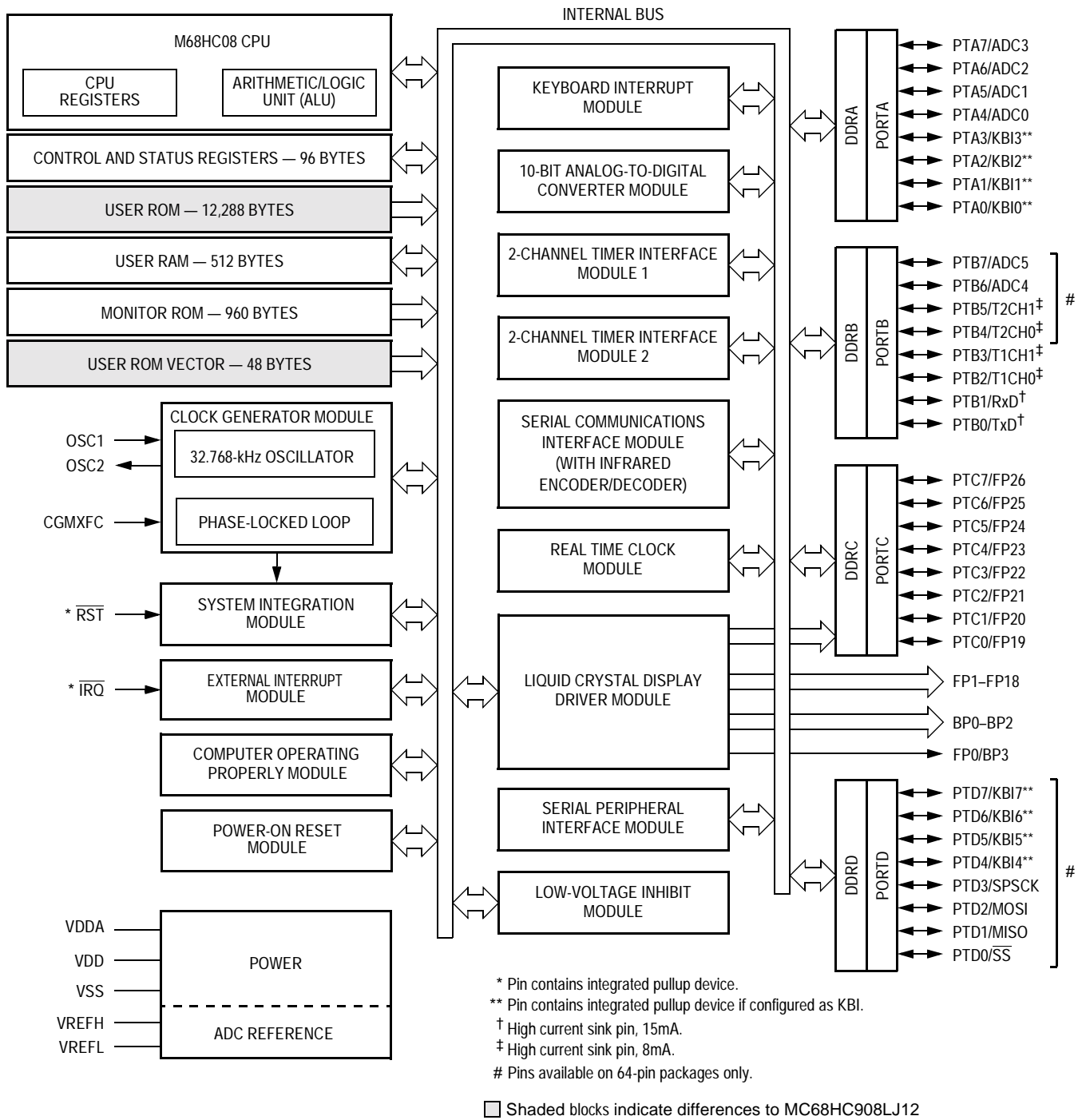

Figure 4. MC68HC08LJ12 Block Diagram

\$0000 ↓ \$005F	I/O Registers 96 Bytes
\$0060 ↓ \$025F	RAM 512 Bytes
\$0260 ↓ \$BFFF	Unimplemented 48,544 Bytes
\$C000 ↓ \$EFFF	ROM 12,288 Bytes
\$F000 ↓ \$FBFF	Unimplemented 3,072 Bytes
\$FC00 ↓ \$FDFF	Monitor ROM 1 512 Bytes
\$FE00	SIM Break Status Register (SBSR)
\$FE01	SIM Reset Status Register (SRSR)
\$FE02	Reserved
\$FE03	SIM Break Flag Control Register (SBFCR)
\$FE04	Interrupt Status Register 1 (INT1)
\$FE05	Interrupt Status Register 2 (INT2)
\$FE06	Interrupt Status Register 3 (INT3)
\$FE07	Reserved
\$FE08	Reserved
\$FE09	Reserved
\$FE0A	Reserved
\$FE0B	Reserved
\$FE0C	Break Address Register High (BRKH)
\$FE0D	Break Address Register Low (BRKL)
\$FE0E	Break Status and Control Register (BRKSCR)
\$FE0F	LVI Status Register (LVISR)
\$FE10 ↓ \$FFCF	Monitor ROM 2 448 Bytes
\$FFD0 ↓ \$FFFF	ROM Vectors 48 Bytes

**Figure 5. MC68HC08LJ12 Memory Map**

### Electrical Specifications

Electrical specifications for the MC68HC908LJ12 apply to the MC68HC08LJ12 except for the parameters indicated below.

### Functional Operating Range

**Table 9. Operating Range**

Characteristic	Symbol	Value	Unit
Operating temperature range	$T_A$	-40 to +85	°C
Operating voltage range	$V_{DD}$	5.0V ± 10%	V

### RAM Memory Characteristics

**Table 10. Memory Characteristics**

Characteristic	Symbol	Min.	Max.	Unit
RAM data retention voltage	$V_{RDR}$	1.3	—	V

Notes:

Since MC68HC08LJ12 is a ROM device, FLASH memory electrical characteristics do not apply.

### MC68HC08LJ12 Order Numbers

These part numbers are generic numbers only. To place an order, ROM code must be submitted to the ROM Processing Center (RPC).

**Table 11. MC68HC08LJ12 Order Numbers**

MC Order Number	Package	Operating Temperature Range
MC68HC08LJ12CFB	52-pin LQFP	-40 °C to +85 °C
MC68HC08LJ12CPB	64-pin LQFP	-40 °C to +85 °C
MC68HC08LJ12CFU	64-pin QFP	-40 °C to +85 °C

**AMENDMENTS TO MC68HC908LJ12/D, REV. 2**

**5.0V DC Electrical Characteristics** Pages 394 and 395, *Table 23-4 5.0V DC Electrical Characteristics* — Delete LVI typical values and correct note 6.

*From:*

Characteristic	Symbol	Min	Typ	Max	Unit
Low-voltage inhibit, trip falling voltage	V <sub>TRIPF</sub>	4.00	4.32	4.70	V
Low-voltage inhibit, trip rising voltage	V <sub>TRIPR</sub>	4.00	4.32	4.70	V

**Notes:**

6. LCD driver configured for high current mode.

*To:*

Characteristic	Symbol	Min	Typ	Max	Unit
Low-voltage inhibit, trip falling voltage	V <sub>TRIPF</sub>	4.00	—	4.70	V
Low-voltage inhibit, trip rising voltage	V <sub>TRIPR</sub>	4.00	—	4.70	V

**Notes:**

6. LCD driver configured for low current mode.

**3.3V DC Electrical Characteristics** Pages 396 and 397, *Table 23-5 3.3V DC Electrical Characteristics* — Delete LVI typical values and correct note 6.

*From:*

Characteristic	Symbol	Min	Typ	Max	Unit
Low-voltage inhibit, trip falling voltage	V <sub>TRIPF</sub>	2.40	2.57	2.88	V
Low-voltage inhibit, trip rising voltage	V <sub>TRIPR</sub>	2.46	2.63	2.97	V

**Notes:**

6. LCD driver configured for high current mode.

*To:*

Characteristic	Symbol	Min	Typ	Max	Unit
Low-voltage inhibit, trip falling voltage	V <sub>TRIPF</sub>	2.40	—	2.88	V
Low-voltage inhibit, trip rising voltage	V <sub>TRIPR</sub>	2.46	—	2.97	V

**Notes:**

6. LCD driver configured for low current mode.

**Oscillator Characteristics**

Page 398, **Table 23-8 5.0V Oscillator Specifications** and **Table 23-9 3.3V Oscillator Specifications** — Replace *Internal oscillator clock frequency* values.

*From:*

Characteristic	Symbol	Min	Typ	Max	Unit
Internal oscillator clock frequency	$f_{\text{CLK}}$	46k	47k	48k	Hz

Characteristic	Symbol	Min	Typ	Max	Unit
Internal oscillator clock frequency	$f_{\text{CLK}}$	42.8k	43.4k	44k	Hz

*To:* See **Figure 1 . Typical Internal Oscillator Frequency** on page 6 of this document.

---

— END —



# Freescale Semiconductor, Inc.

## Home Page:

[www.freescale.com](http://www.freescale.com)

## email:

[support@freescale.com](mailto:support@freescale.com)

## USA/Europe or Locations Not Listed:

Freescale Semiconductor  
Technical Information Center, CH370  
1300 N. Alma School Road  
Chandler, Arizona 85224  
(800) 521-6274  
480-768-2130

[support@freescale.com](mailto:support@freescale.com)

## Europe, Middle East, and Africa:

Freescale Halbleiter Deutschland GmbH  
Technical Information Center  
Schatzbogen 7  
81829 Muenchen, Germany  
+44 1296 380 456 (English)  
+46 8 52200080 (English)  
+49 89 92103 559 (German)  
+33 1 69 35 48 48 (French)

[support@freescale.com](mailto:support@freescale.com)

## Japan:

Freescale Semiconductor Japan Ltd.  
Headquarters  
ARCO Tower 15F  
1-8-1, Shimo-Meguro, Meguro-ku  
Tokyo 153-0064, Japan  
0120 191014  
+81 2666 8080  
[support.japan@freescale.com](mailto:support.japan@freescale.com)

## Asia/Pacific:

Freescale Semiconductor Hong Kong Ltd.  
Technical Information Center  
2 Dai King Street  
Tai Po Industrial Estate,  
Tai Po, N.T., Hong Kong  
+800 2666 8080  
[support.asia@freescale.com](mailto:support.asia@freescale.com)

## For Literature Requests Only:

Freescale Semiconductor  
Literature Distribution Center  
P.O. Box 5405  
Denver, Colorado 80217  
(800) 441-2447  
303-675-2140  
Fax: 303-675-2150  
[LDCForFreescaleSemiconductor@hibbertgroup.com](mailto:LDCForFreescaleSemiconductor@hibbertgroup.com)

RoHS-compliant and/or Pb- free versions of Freescale products have the functionality and electrical characteristics of their non-RoHS-compliant and/or non-Pb- free counterparts. For further information, see <http://www.freescale.com> or contact your Freescale sales representative.

For information on Freescale's Environmental Products program, go to <http://www.freescale.com/epp>.

Information in this document is provided solely to enable system and software implementers to use Freescale Semiconductor products. There are no express or implied copyright licenses granted hereunder to design or fabricate any integrated circuits or integrated circuits based on the information in this document. Freescale Semiconductor reserves the right to make changes without further notice to any products herein. Freescale Semiconductor makes no warranty, representation or guarantee regarding the suitability of its products for any particular purpose, nor does Freescale Semiconductor assume any liability arising out of the application or use of any product or circuit, and specifically disclaims any and all liability, including without limitation consequential or incidental damages. "Typical" parameters which may be provided in Freescale Semiconductor data sheets and/or specifications can and do vary in different applications and actual performance may vary over time. All operating parameters, including "Typicals" must be validated for each customer application by customer's technical experts. Freescale Semiconductor does not convey any license under its patent rights nor the rights of others. Freescale Semiconductor products are not designed, intended, or authorized for use as components in systems intended for surgical implant into the body, or other applications intended to support or sustain life, or for any other application in which the failure of the Freescale Semiconductor product could create a situation where personal injury or death may occur. Should Buyer purchase or use Freescale Semiconductor products for any such unintended or unauthorized application, Buyer shall indemnify and hold Freescale Semiconductor and its officers, employees, subsidiaries, affiliates, and distributors harmless against all claims, costs, damages, and expenses, and reasonable attorney fees arising out of, directly or indirectly, any claim of personal injury or death associated with such unintended or unauthorized use, even if such claim alleges that Freescale Semiconductor was negligent regarding the design or manufacture of the part.



HC908LJ12AD/D  
Rev. 0  
6/2003

**For More Information On This Product,  
Go to: [www.freescale.com](http://www.freescale.com)**