

Silicon Epitaxial Planar Diodes

Features

- Saving space
- Hermetic sealed parts
- Fits onto SOD 323 / SOT 23 footprints
- Electrical data identical with the devices 1N4148 and 1N4448 respectively
- Micro Melf package

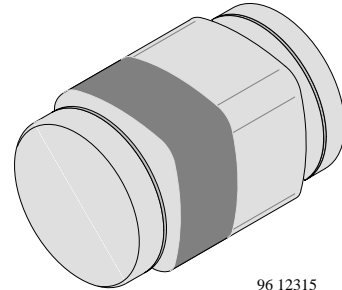

96 12315

Applications

Extreme fast switches

Absolute Maximum Ratings

 $T_j = 25^\circ\text{C}$

Parameter	Test Conditions	Type	Symbol	Value	Unit
Repetitive peak reverse voltage			V_{RRM}	100	V
Reverse voltage			V_R	75	V
Peak forward surge current	$t_p=1\mu\text{s}$		I_{FSM}	2	A
Repetitive peak forward current			I_{FRM}	450	mA
Forward current			I_F	200	mA
Average forward current	$V_R=0$		I_{FAV}	150	mA
Power dissipation			P_V	500	mW
Junction temperature			T_j	175	$^\circ\text{C}$
Storage temperature range			T_{stg}	-65...+175	$^\circ\text{C}$

Maximum Thermal Resistance

 $T_j = 25^\circ\text{C}$

Parameter	Test Conditions	Symbol	Value	Unit
Junction ambient	mounted on epoxy-glass hard tissue, Fig. 1, 35 μm copper clad, 0.9 mm ² copper area per electrode	R_{thJA}	500	K/W

Electrical Characteristics

$T_j = 25^\circ\text{C}$

Parameter	Test Conditions	Type	Symbol	Min	Typ	Max	Unit
Forward voltage	$I_F=5\text{mA}$	MCL4448	V_F	0.62		0.72	V
	$I_F=50\text{mA}$	MCL4148	V_F		0.86	1	V
	$I_F=100\text{mA}$	MCL4448	V_F		0.93	1	V
Reverse current	$V_R=20\text{V}$		I_R			25	nA
	$V_R=20\text{V}, T_j=150^\circ\text{C}$		I_R			50	μA
	$V_R=75\text{V}$		I_R			5	μA
Breakdown voltage	$I_R=100\mu\text{A}, t_p/T=0.01,$ $t_p=0.3\text{ms}$		$V_{(BR)}$	100			V
Diode capacitance	$V_R=0, f=1\text{MHz}, V_{HF}=50\text{mV}$		C_D			4	pF
Rectification efficiency	$V_{HF}=2\text{V}, f=100\text{MHz}$		η_r	45			%
Reverse recovery time	$I_F=I_R=10\text{mA}, i_R=1\text{mA}$		t_{rr}			8	ns
	$I_F=10\text{mA}, V_R=6\text{V}, i_R=0.1I_R,$ $R_L=100\Omega$		t_{rr}			4	ns

Characteristics ($T_j = 25^\circ\text{C}$ unless otherwise specified)

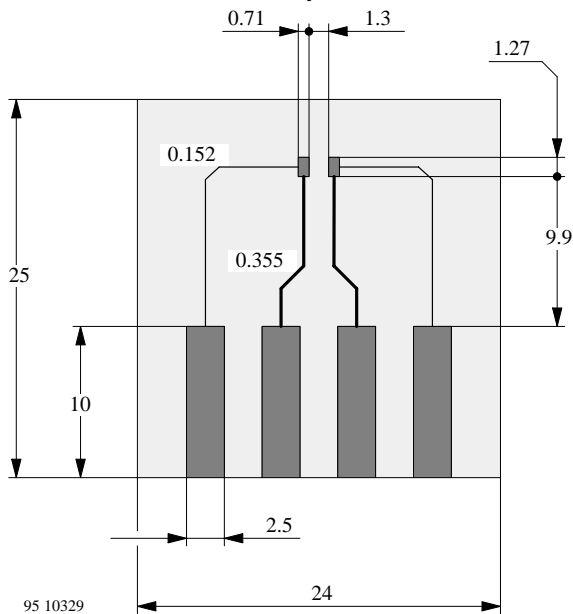

Figure 1. Board for R_{thJA} definition (in mm)

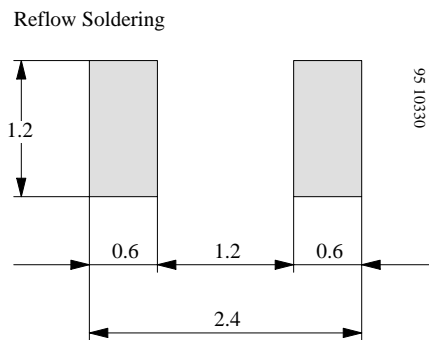

Figure 2. Recommended foot pads (in mm)

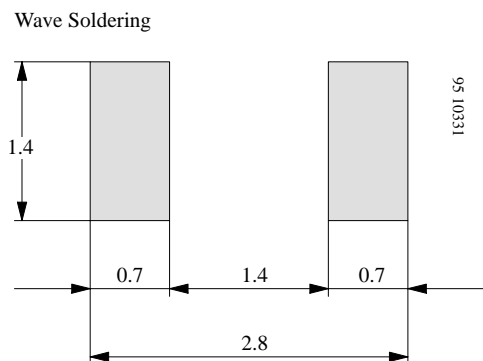

Figure 3. Recommended foot pads (in mm)

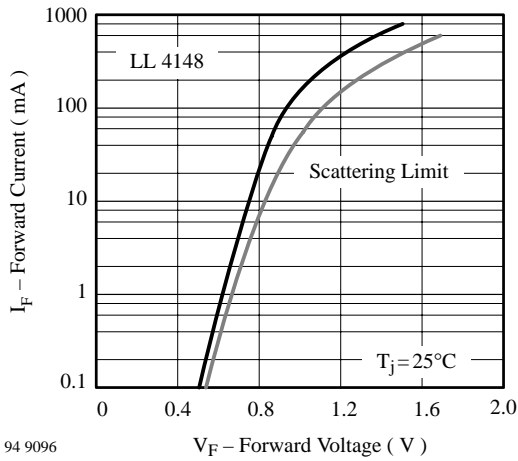

Figure 4. Forward Current vs. Forward Voltage

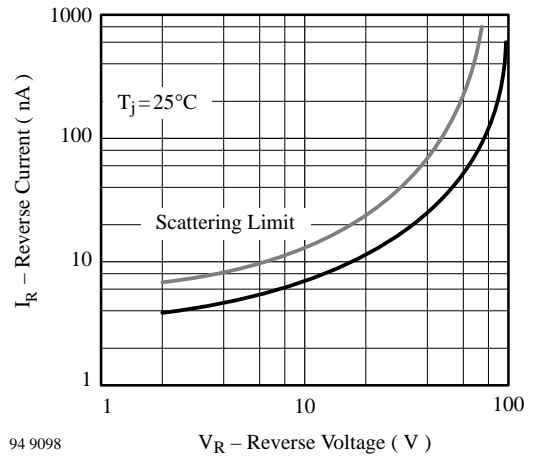

Figure 6. Reverse Current vs. Reverse Voltage

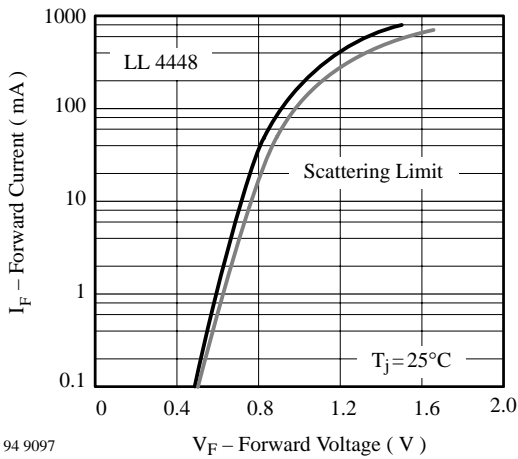

Figure 5. Forward Current vs. Forward Voltage

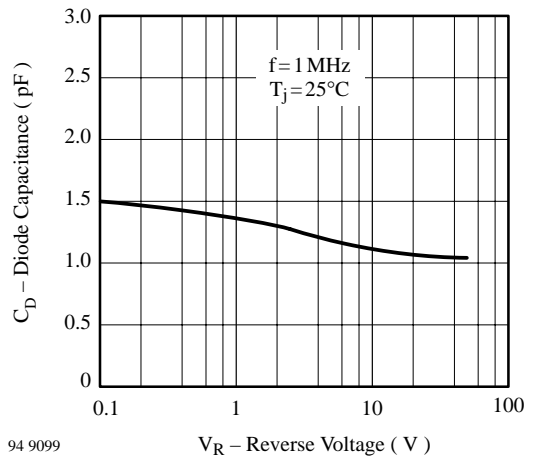
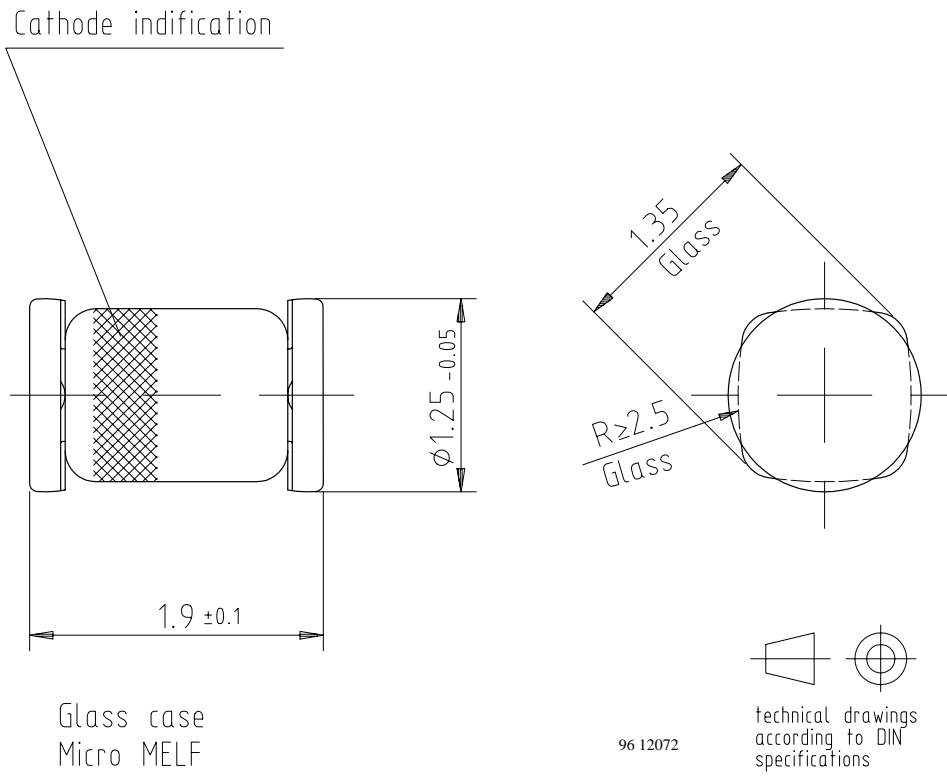

Figure 7. Diode Capacitance vs. Reverse Voltage

Dimensions in mm





Ozone Depleting Substances Policy Statement

It is the policy of **Vishay Semiconductor GmbH** to

1. Meet all present and future national and international statutory requirements.
2. Regularly and continuously improve the performance of our products, processes, distribution and operating systems
with respect to their impact on the health and safety of our employees and the public, as well as their impact on the environment.

It is particular concern to control or eliminate releases of those substances into the atmosphere which are known as ozone depleting substances (ODSs).

The Montreal Protocol (1987) and its London Amendments (1990) intend to severely restrict the use of ODSs and forbid their use within the next ten years. Various national and international initiatives are pressing for an earlier ban on these substances.

Vishay Semiconductor GmbH has been able to use its policy of continuous improvements to eliminate the use of ODSs listed in the following documents.

1. Annex A, B and list of transitional substances of the Montreal Protocol and the London Amendments respectively
2. Class I and II ozone depleting substances in the Clean Air Act Amendments of 1990 by the Environmental Protection Agency (EPA) in the USA
3. Council Decision 88/540/EEC and 91/690/EEC Annex A, B and C (transitional substances) respectively.

Vishay Semiconductor GmbH can certify that our semiconductors are not manufactured with ozone depleting substances and do not contain such substances.

We reserve the right to make changes to improve technical design and may do so without further notice.

Parameters can vary in different applications. All operating parameters must be validated for each customer application by the customer. Should the buyer use Vishay-Telefunken products for any unintended or unauthorized application, the buyer shall indemnify Vishay-Telefunken against all claims, costs, damages, and expenses, arising out of, directly or indirectly, any claim of personal damage, injury or death associated with such unintended or unauthorized use.

Vishay Semiconductor GmbH, P.O.B. 3535, D-74025 Heilbronn, Germany
Telephone: 49 (0) 7131 67 2831, Fax number: 49 (0) 7131 67 2423