

High Power Thyristor Modules

$I_{TRMS} = 880 \text{ A}$
 $I_{T(AV)M} = 560 \text{ A}$
 $V_{RRM} = 1200\text{-}1800 \text{ V}$

V_{RSM}	V_{RRM}	Type
V_{DSM}	V_{DRM}	
V	V	
1300	1200	MCO 500-12io1
1500	1400	MCO 500-14io1
1700	1600	MCO 500-16io1
1900	1800	MCO 500-18io1

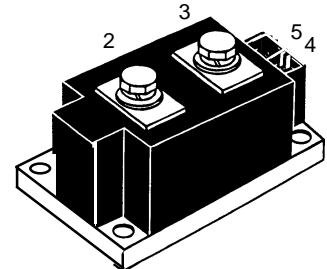
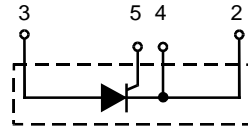

Symbol	Test Conditions	Maximum Ratings	
I_{TRMS}	$T_{VJ} = T_{VJM}$	880	A
$I_{T(AV)M}$	$T_C = 85^\circ\text{C}; 180^\circ \text{ sine}$	560	A
I_{TSM}	$T_{VJ} = 45^\circ\text{C}$	$t = 10 \text{ ms (50 Hz)}$	17000 A
	$V_R = 0$	$t = 8.3 \text{ ms (60 Hz)}$	16000 A
	$T_{VJ} = T_{VJM}$	$t = 10 \text{ ms (50 Hz)}$	13000 A
	$V_R = 0$	$t = 8.3 \text{ ms (60 Hz)}$	14400 A
I^2t	$T_{VJ} = 45^\circ\text{C}$	$t = 10 \text{ ms (50 Hz)}$	1445000 A^2s
	$V_R = 0$	$t = 8.3 \text{ ms (60 Hz)}$	1062000 A^2s
	$T_{VJ} = T_{VJM}$	$t = 10 \text{ ms (50 Hz)}$	845000 A^2s
	$V_R = 0$	$t = 8.3 \text{ ms (60 Hz)}$	813000 A^2s
$(di/dt)_{cr}$	$T_{VJ} = T_{VJM}$ repetitive, $I_T = 960 \text{ A}$	$f = 50 \text{ Hz}, t_p = 200 \mu\text{s}$	100 $A/\mu\text{s}$
	$V_D = 2/3 V_{DRM}$	$I_G = 1 \text{ A},$ non repetitive, $I_T = I_{T(AV)M}$	500 $A/\mu\text{s}$
	$di_G/dt = 1 \text{ A}/\mu\text{s}$		
$(dv/dt)_{cr}$	$T_{VJ} = T_{VJM}; V_{DR} = 2/3 V_{DRM}$		1000 $V/\mu\text{s}$
	$R_{GK} = \infty;$ method 1 (linear voltage rise)		
P_{GM}	$T_{VJ} = T_{VJM}$	$t_p = 30 \mu\text{s}$	120 W
	$I_T = I_{T(AV)M}$	$t_p = 500 \mu\text{s}$	60 W
P_{GAV}			30 W
V_{RGM}			10 V
T_{VJ}			-40...140 $^\circ\text{C}$
T_{VJM}			140 $^\circ\text{C}$
T_{stg}			-40...125 $^\circ\text{C}$
V_{ISOL}	50/60 Hz, RMS	$t = 1 \text{ min}$	3000 V~
	$I_{ISOL} \leq 1 \text{ mA}$	$t = 1 \text{ s}$	3600 V~
M_d	Mounting torque (M6)		4.5-7/40-62 Nm/lb.in.
	Terminal connection torque (M8)		11-13/97-115 Nm/lb.in.
Weight	Typical including screws		650 g

Features

- International standard package
- Direct copper bonded Al_2O_3 -ceramic with copper base plate
- Planar passivated chips
- Isolation voltage 3600 V~
- UL registered E 72873
- Keyed gate/cathode twin pins

Applications

- Motor control, softstarter
- Power converter
- Heat and temperature control for industrial furnaces and chemical processes
- Lighting control
- Solid state switches

Advantages

- Simple mounting
- Improved temperature and power cycling
- Reduced protection circuits

Data according to IEC 60747 refer to a single thyristor/diode unless otherwise stated. IXYS reserves the right to change limits, test conditions and dimensions

Symbol	Test Conditions	Characteristic Values	
I_{RRM}	$T_{VJ} = T_{VJM}; V_R = V_{RRM}$	40	mA
V_T	$I_T = 1200 \text{ A}; T_{VJ} = 25^\circ\text{C}$	1.3	V
V_{T0}	For power-loss calculations only ($T_{VJ} = T_{VJM}$)	0.8	V
r_T		0.38	m Ω
V_{GT}	$V_D = 6 \text{ V}; T_{VJ} = 25^\circ\text{C}$	2	V
	$T_{VJ} = -40^\circ\text{C}$	3	V
I_{GT}	$V_D = 6 \text{ V}; T_{VJ} = 25^\circ\text{C}$	300	mA
	$T_{VJ} = -40^\circ\text{C}$	400	mA
V_{GD}	$T_{VJ} = T_{VJM}; V_D = 2/3 V_{DRM}$	0.25	V
I_{GD}	$T_{VJ} = T_{VJM}; V_D = 2/3 V_{DRM}$	10	mA
I_L	$T_{VJ} = 25^\circ\text{C}; V_D = 6 \text{ V}; t_p = 30 \mu\text{s}$ $di_G/dt = 1 \text{ A}/\mu\text{s}; I_G = 1 \text{ A}$	400	mA
I_H	$T_{VJ} = 25^\circ\text{C}; V_D = 6 \text{ V}; R_{GK} = \infty$	300	mA
t_{gd}	$T_{VJ} = 25^\circ\text{C}; V_D = 1/2 V_{DRM}$ $di_G/dt = 1 \text{ A}/\mu\text{s}; I_G = 1 \text{ A}$	2	μs
t_q	$T_{VJ} = T_{VJM}; V_R = 100 \text{ V}; V_D = 2/3 V_{DRM}; t_p = 200 \mu\text{s}$ $dv/dt = 50 \text{ V}/\mu\text{s}; I_T = 500 \text{ A}; -di/dt = 10 \text{ A}/\mu\text{s}$	typ. 350	μs
R_{thJC}	DC current	0.072	K/W
R_{thJK}	DC current	0.096	K/W
d_s	Creeping distance on surface	12.7	mm
d_A	Creepage distance in air	9.6	mm
a	Maximum allowable acceleration	50	m/s ²

Optional accessories for modules

Keyed Gate/Cathode twin plugs with wire length = 350 mm, gate = yellow, cathode = red

Type **ZY 180 L** (L = Left for pin pair 4/5) $\left\{ \begin{array}{l} \text{UL 758, style 1385,} \\ \text{CSA class 5851, guide 460-1-1} \end{array} \right.$

Dimensions in mm (1 mm = 0.0394")

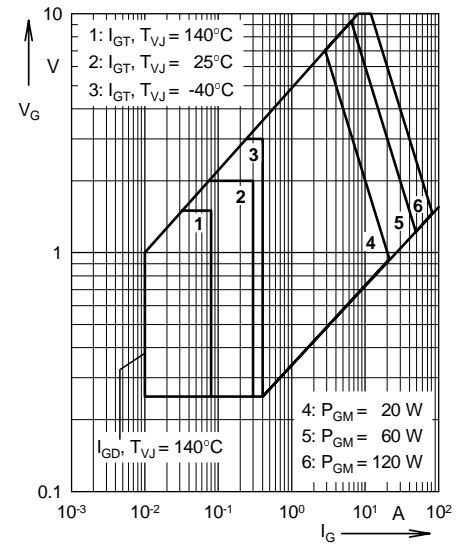
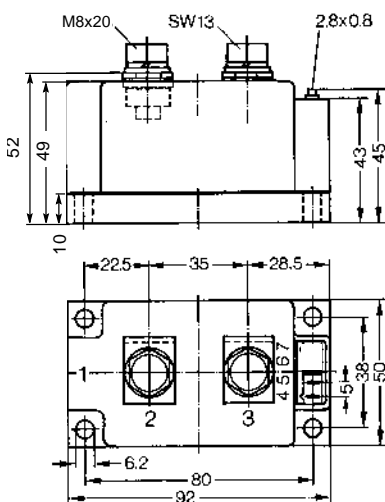

Fig. 1 Gate trigger characteristics

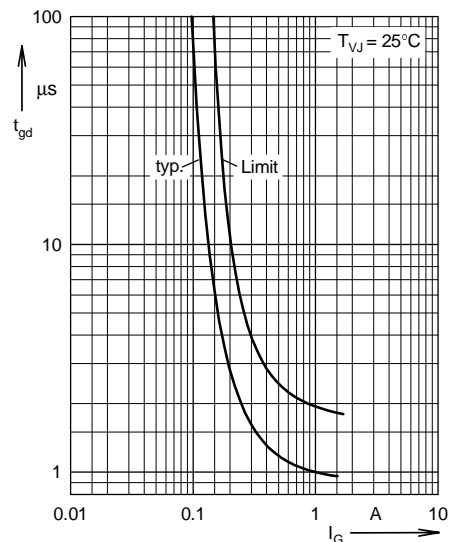

Fig. 2 Gate trigger delay time

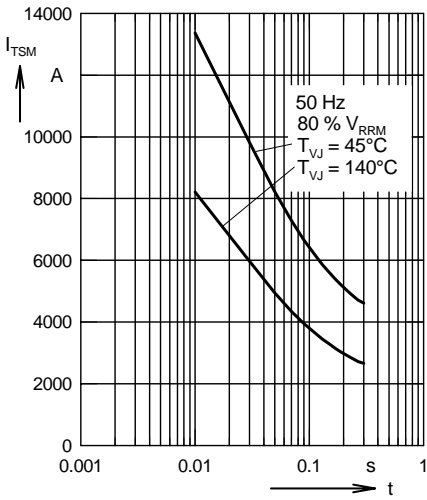

Fig. 3 Surge overload current
 I_{TSM} , I_{FSM} : Crest value, t : duration

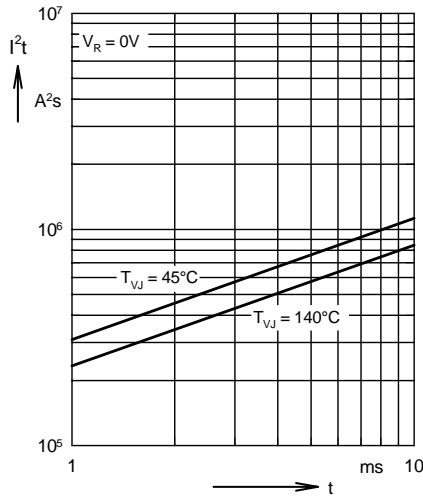

Fig. 4 $\int i^2 dt$ versus time (1-10 ms)

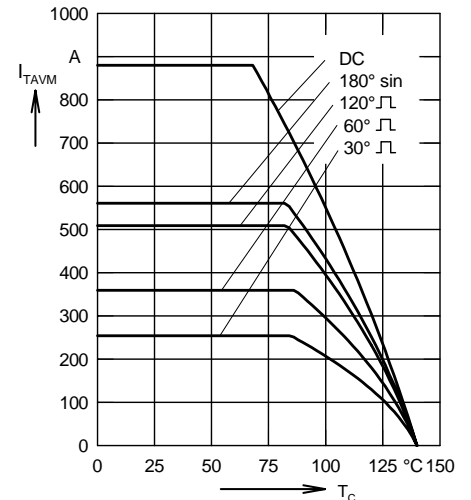

Fig. 5 Maximum forward current at case temperature

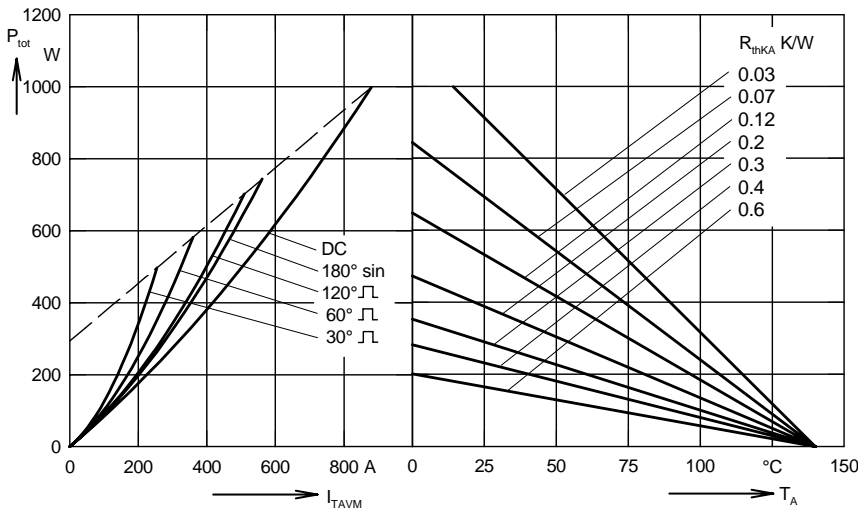

Fig. 6 Power dissipation versus on-state current and ambient temperature

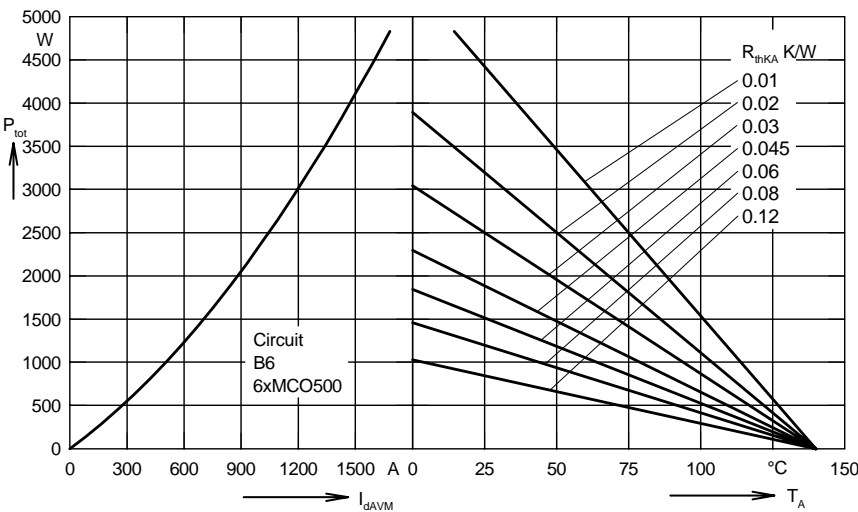

Fig. 7 Three phase rectifier bridge: Power dissipation versus direct output current and ambient temperature

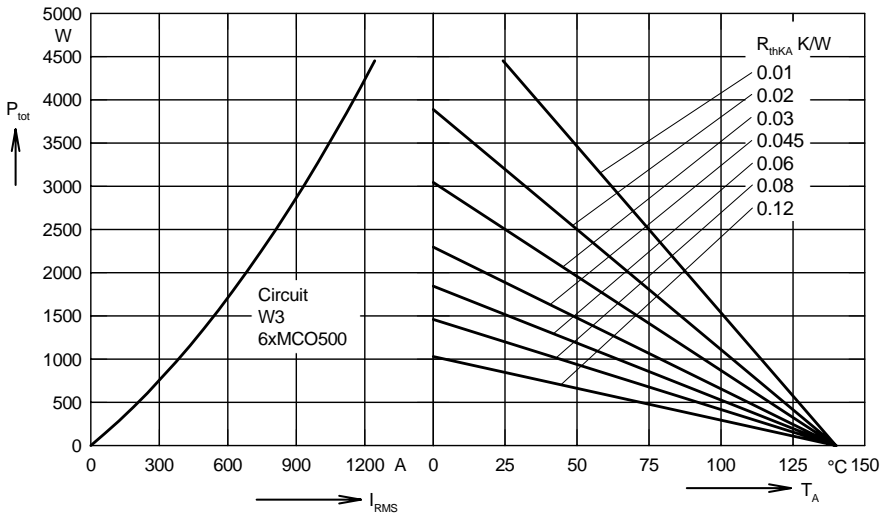

Fig. 8 Three phase AC-controller: Power dissipation versus RMS output current and ambient temperature

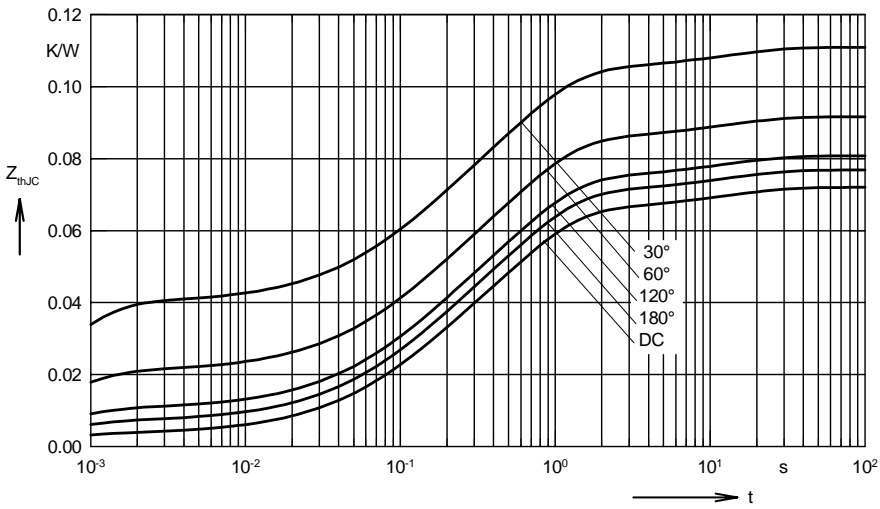

Fig. 9 Transient thermal impedance junction to case (per thyristor)

R_{thJC} for various conduction angles d :

d	R_{thJC} (K/W)
DC	0.072
180°	0.0768
120°	0.081
60°	0.092
30°	0.111

Constants for Z_{thJC} calculation:

i	R_{thi} (K/W)	t_i (s)
1	0.0035	0.0054
2	0.0186	0.098
3	0.0432	0.54
4	0.0067	12

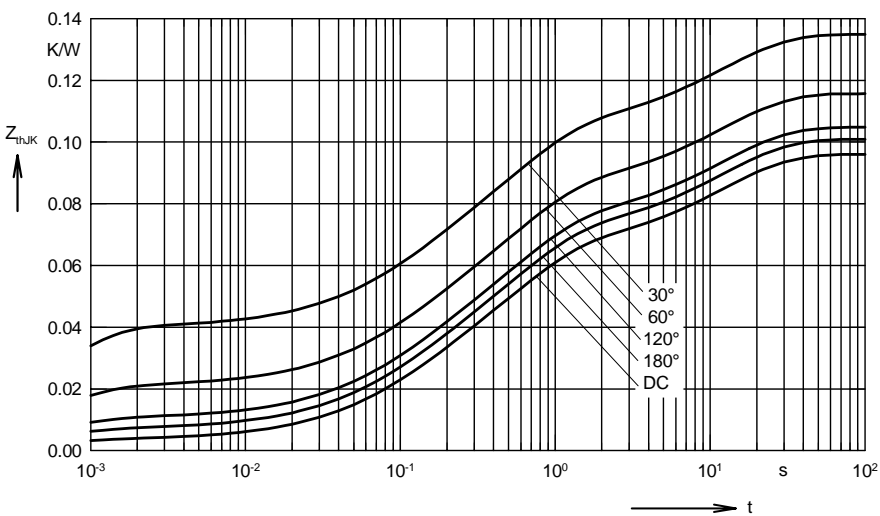

Fig.10 Transient thermal impedance junction to heatsink (per thyristor)

R_{thJK} for various conduction angles d :

d	R_{thJK} (K/W)
DC	0.096
180°	0.1
120°	0.105
60°	0.116
30°	0.135

Constants for Z_{thJK} calculation:

i	R_{thi} (K/W)	t_i (s)
1	0.0035	0.0054
2	0.0186	0.098
3	0.0432	0.54
4	0.0067	12
5	0.024	12