

MCT5200

MCT5201

MCT5210

MCT5211

Description

The MCT52XX series consists of a high-efficiency AlGaAs, infrared emitting diode, coupled with an NPN phototransistor in a six pin dual-in-line package.

The MCT52XX is well suited for CMOS to LSTT/TTL interfaces, offering 250% $CTR_{CE(SAT)}$ with 1 mA of LED input current. When an LED input current of 1.6 mA is supplied data rates to 20K bits/s are possible.

The MCT52XX can easily interface LSTTL to LSTTL/TTL, and with use of an external base to emitter resistor data rates of 100K bits/s can be achieved.

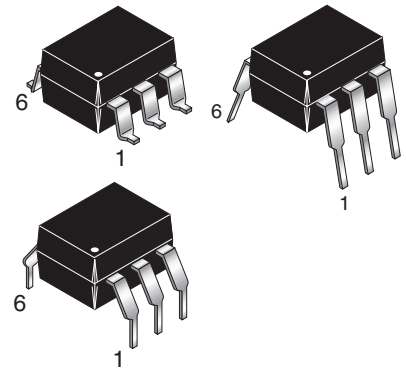

Features

- High $CTR_{CE(SAT)}$ comparable to Darlington
- CTR guaranteed 0°C to 70°C
- High common mode transient rejection 5kV/μs
- Data rates up to 150 kbits/s (NRZ)
- Underwriters Laboratory (UL) recognized (file #E90700)
- VDE recognized (file #94766)
 - Add option 300 (e.g., MCT5211.300)

Applications

- CMOS to CMOS/LSTTL logic isolation
- LSTTL to CMOS/LSTTL logic isolation
- RS-232 line receiver
- Telephone ring detector
- AC line voltage sensing
- Switching power supply

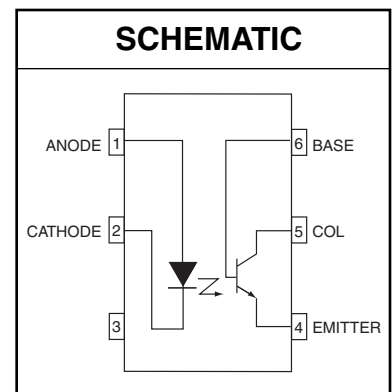

Parameters	Symbol	Device	Value	Units
TOTAL DEVICE				
Storage Temperature	T_{STG}	All	-55 to +150	°C
Operating Temperature	T_{OPR}	All	-55 to +100	°C
Lead Solder Temperature	T_{SOL}	All	260 for 10 sec	°C
Total Device Power Dissipation @ 25°C (LED plus detector) Derate Linearly From 25°C	P_D	All	260	mW
			3.5	mW/°C
EMITTER				
Continuous Forward Current	I_F	All	50	mA
Reverse Input Voltage	V_R	All	6	V
Forward Current - Peak (1 μs pulse, 300 pps)	$I_F(pk)$	All	3.0	A
LED Power Dissipation Derate Linearly From 25°C	P_D	All	75	mW
		All	1.0	mW/°C
DETECTOR				
Continuous Collector Current	I_C	All	150	mA
Detector Power Dissipation Derate Linearly from 25°C	P_D	All	150	mW
		All	2.0	mW/°C

MCT5200

MCT5201

MCT5210

MCT5211

ELECTRICAL CHARACTERISTICS ($T_A = 25^\circ\text{C}$ Unless otherwise specified.)

INDIVIDUAL COMPONENT CHARACTERISTICS

Parameters	Test Conditions	Symbol	Device	Min	Typ**	Max	Units
EMITTER							
Input Forward Voltage	($I_F = 5 \text{ mA}$)	V_F	All		1.25	1.5	V
Forward Voltage Temp. Coefficient	($I_F = 2 \text{ mA}$)	$\frac{\Delta V_F}{\Delta T_A}$	All		-1.75		mV/ °C
Reverse Voltage	($I_R = 10 \mu\text{A}$)	V_R	All	6			V
Junction Capacitance	($V_F = 0 \text{ V}$, $f = 1.0 \text{ MHz}$)	C_J	All		18		pF
DETECTOR							
Collector-Emitter Breakdown Voltage	($I_C = 1.0 \text{ mA}$, $I_F = 0$)	BV_{CEO}	All	30	100		V
Collector-Base Breakdown Voltage	($I_C = 10 \mu\text{A}$, $I_F = 0$)	BV_{CBO}	All	30	120		V
Emitter-Base Breakdown Voltage	($I_C = 10 \mu\text{A}$, $I_F = 0$)	BV_{EBO}	All	5	10		V
Collector-Emitter Dark Current	($V_{CE} = 10\text{V}$, $I_F = 0$, $R_{BE} = 1\text{M}\Omega$)	I_{CER}	All		1	100	nA
Capacitance	Collector to Emitter	($V_{CE} = 0$, $f = 1 \text{ MHz}$)	C_{CE}	All		10	pF
	Collector to Base	($V_{CB} = 0$, $f = 1 \text{ MHz}$)	C_{CB}	All		80	pF
	Emitter to Base	($V_{EB} = 0$, $f = 1 \text{ MHz}$)	C_{EB}	All		15	pF

ISOLATION CHARACTERISTICS

Characteristic	Test Conditions	Symbol	Device	Min	Typ**	Max	Units
Input-Output Isolation Voltage ⁽¹⁰⁾	($f = 60\text{Hz}$, $t = 1 \text{ min.}$)	V_{ISO}	All	5300			Vac(rms)
Isolation Resistance ⁽¹⁰⁾	$V_{I-O} = 500 \text{ VDC}$, $T_A = 25^\circ\text{C}$	R_{ISO}	All	10^{11}			Ω
Isolation Capacitance ⁽⁹⁾	$V_{I-O} = 0$, $f = 1 \text{ MHz}$	C_{ISO}	All		0.7		pF
Common Mode Transient Rejection – Output High	$V_{CM} = 50 \text{ V}_{P-P1}$, $R_L = 750\Omega$, $I_F = 0$	CM_H	MCT5210/11		5000		V/ μs
	$V_{CM} = 50 \text{ V}_{P-P}$, $R_L = 1\text{K}\Omega$, $I_F = 0$		MCT5200/01				
Common Mode Transient Rejection – Output Low	$V_{CM} = 50 \text{ V}_{P-P1}$, $R_L = 750\Omega$, $I_F = 1.6\text{mA}$	CM_L	MCT5210/11		5000		V/ μs
	$V_{CM} = 50 \text{ V}_{P-P1}$, $R_L = 1\text{K}\Omega$, $I_F = 5 \text{ mA}$		MCT5200/01				

**All typical $T_A=25^\circ\text{C}$

MCT5200

MCT5201

MCT5210

MCT5211

TRANSFER CHARACTERISTICS (T _A = 0°C to 70°C Unless otherwise specified.)								
DC Characteristics	Test Conditions	Symbol	Device	Min	Typ**	Max	Units	
Saturated Current Transfer Ratio ⁽¹⁾ (Collector to Emitter)	I _F = 10 mA, V _{CE} = 0.4 V	CTR _{CE(SAT)}	MCT5200	75			%	
	I _F = 5 mA, V _{CE} = 0.4 V		MCT5201	120				
	I _F = 3.0 mA, V _{CE} = 0.4 V		MCT5210	60				
	I _F = 1.6 mA, V _{CE} = 0.4 V		MCT5211	100				
	I _F = 1.0 mA, V _{CE} = 0.4 V			75				
Current Transfer Ratio (Collector to Emitter) ⁽¹⁾	I _F = 3.0 mA, V _{CE} = 5.0 V	CTR _(CE)	MCT5210	70			%	
	I _F = 1.6 mA, V _{CE} = 5.0 V		MCT5211	150				
	I _F = 1.0 mA, V _{CE} = 5.0 V			110				
Current Transfer Ratio Collector to Base ⁽²⁾	I _F = 10 mA, V _{CB} = 4.3 V	CTR _(CB)	MCT5200	0.2			%	
	I _F = 5 mA, V _{CB} = 4.3 V		MCT5201	0.28				
	I _F = 3.0 mA, V _{CE} = 4.3 V		MCT5210	0.2				
	I _F = 1.6 mA, V _{CE} = 4.3 V			0.3				
	I _F = 1.0 mA, V _{CE} = 4.3 V			0.25				
Saturation Voltage	I _F = 10 mA, I _{CE} = 7.5 mA	V _{CE(SAT)}	MCT5200			0.4	V	
	I _F = 5 mA, I _{CE} = 6 mA		MCT5201			0.4		
	I _F = 3.0 mA, I _{CE} = 1.8 mA		MCT5210			0.4		
	I _F = 1.6 mA, I _{CE} = 1.6 mA		MCT5211			0.4		
AC Characteristics	Test Conditions	Symbol	Device	Min	Typ	Max	Units	
Propagation Delay High to Low ⁽³⁾	R _L = 330 Ω, R _{BE} = ∞	T _{PHL}	MCT5210		10		μs	
	R _L = 3.3 kΩ, R _{BE} = 39 kΩ				7			
	R _L = 750 Ω, R _{BE} = ∞		MCT5211		14			
	R _L = 4.7 kΩ, R _{BE} = 91 kΩ				15			
	R _L = 1.5 kΩ, R _{BE} = ∞				17			
	R _L = 10 kΩ, R _{BE} = 160 kΩ				24			
	V _{CE} = 0.4V, V _{CC} = 5V, R _L = fig. 13, R _{BE} = 330 kΩ			MCT5200		1.6		12
				MCT5201		3		30
Propagation Delay Low to High ⁽⁴⁾	R _L = 330 Ω, R _{BE} = ∞	T _{PLH}	MCT5210		0.4		μs	
	R _L = 3.3 kΩ, R _{BE} = 39 kΩ				8			
	R _L = 750 Ω, R _{BE} = ∞		MCT5211		2.5			
	R _L = 4.7 kΩ, R _{BE} = 91 kΩ				11			
	R _L = 1.5 kΩ, R _{BE} = ∞				7			
	R _L = 10 kΩ, R _{BE} = 160 kΩ				16			
	V _{CE} = 0.4V, V _{CC} = 5V, R _L = fig. 13, R _{BE} = 330 kΩ			MCT5200		18		20
				MCT5201		12		13
Delay Time ⁽⁵⁾	V _{CE} = 0.4V, R _{BE} = 330 kΩ, R _L = 1 kΩ, V _{CC} = 5V	t _d	MCT5200		0.5	7	μs	
			MCT5201		1.1	15		
Rise Time ⁽⁶⁾	V _{CE} = 0.4V, R _{BE} = 330 kΩ, R _L = 1 kΩ, V _{CC} = 5V	t _r	MCT5200		1.3	6	μs	
			MCT5201		2.5	20		

MCT5200

MCT5201

MCT5210

MCT5211

TRANSFER CHARACTERISTICS ($T_A = 0^\circ\text{C}$ to 70°C Unless otherwise specified.) (Continued)								
DC Characteristics	Test Conditions		Symbol	Device	Min	Typ**	Max	Units
Storage Time ⁽⁷⁾	$V_{CE} = 0.4\text{V}$, $R_{BE} = 330\text{ k}\Omega$, $R_L = 1\text{ k}\Omega$, $V_{CC} = 5\text{V}$	$I_F = 10\text{mA}$	t_s	MCT5200		15	18	μs
		$I_F = 5\text{mA}$		MCT5201		10	13	
Fall Time ⁽⁸⁾	$V_{CE} = 0.4\text{V}$, $R_{BE} = 330\text{ k}\Omega$, $R_L = 1\text{ k}\Omega$, $V_{CC} = 5\text{V}$	$I_F = 10\text{mA}$	t_f	MCT5200		16	30	μs
		$I_F = 5\text{mA}$		MCT5201		16	30	

**All typicals at $T_A = 25^\circ\text{C}$

Notes

- DC Current Transfer Ratio (CTR_{CE}) is defined as the transistor collector current (I_{CE}) divided by the input LED current (I_F) x 100%, at a specified voltage between the collector and emitter (V_{CE}).
- The collector base Current Transfer Ratio (CTR_{CB}) is defined as the transistor collector base photocurrent (I_{CB}) divided by the input LED current (I_F) time 100%.
- Referring to Figure 14 the T_{PHL} propagation delay is measured from the 50% point of the rising edge of the data input pulse to the 1.3V point on the falling edge of the output pulse.
- Referring to Figure 14 the T_{PLH} propagation delay is measured from the 50% point of the falling edge of data input pulse to the 1.3V point on the rising edge of the output pulse.
- Delay time (t_d) is measured from 50% of rising edge of LED current to 90% of V_o falling edge.
- Rise time (t_r) is measured from 90% to 10% of V_o falling edge.
- Storage time (t_s) is measured from 50% of falling edge of LED current to 10% of V_o rising edge.
- Fall time (t_f) is measured from 10% to 90% of V_o rising edge.
- C_{ISO} is the capacitance between the input (pins 1, 2, 3 connected) and the output, (pin 4, 5, 6 connected).
- Device considered a two terminal device: Pins 1, 2, and 3 shorted together, and pins 5, 6 and 7 are shorted together.

MCT5200

MCT5201

MCT5210

MCT5211

TYPICAL PERFORMANCE GRAPHS

Fig. 1 LED Forward Voltage vs. Forward Current

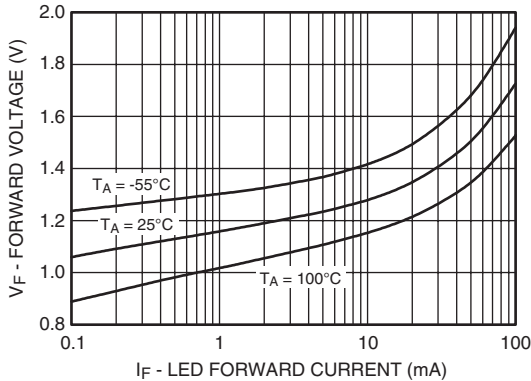

Fig. 2 Normalized Current Transfer Ratio vs. Forward Current

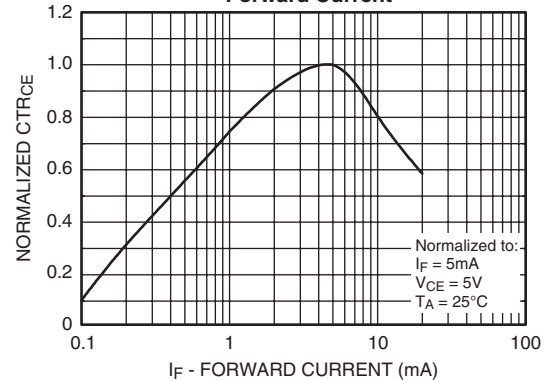

Fig. 3 Normalized CTR vs. Temperature

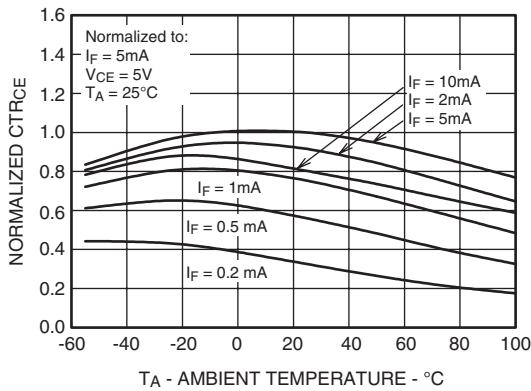

Fig. 4 Normalized Collector vs. Collector - Emitter Voltage

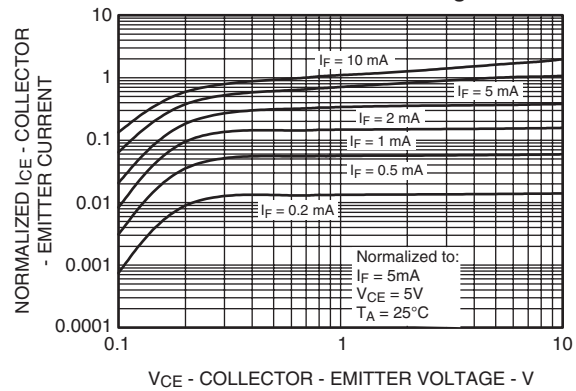

Fig. 5 Normalized Collector Base Photocurrent Ratio vs. Forward Current

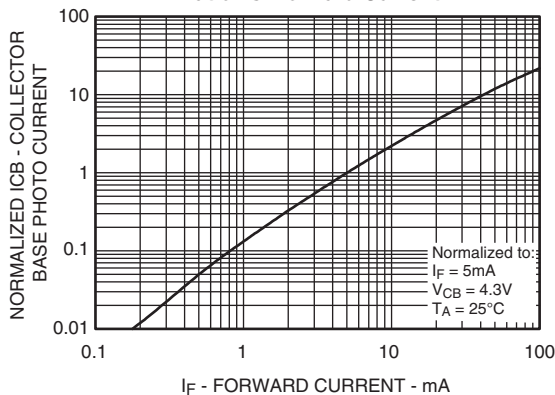
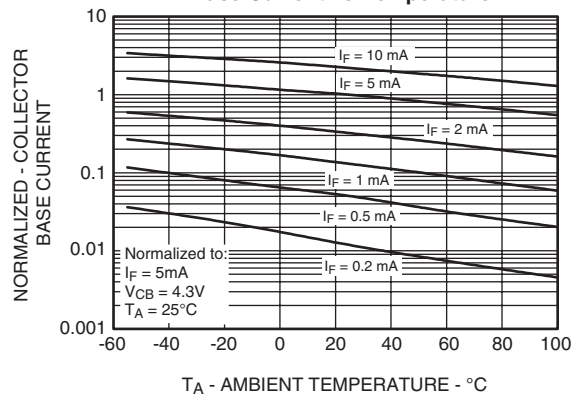

Fig. 6 Normalized Collector - Base Current vs. Temperature



MCT5200

MCT5201

MCT5210

MCT5211

TYPICAL PERFORMANCE GRAPHS (Continued)

Fig. 7 Collector-Emitter Dark Current vs. Ambient Temperature

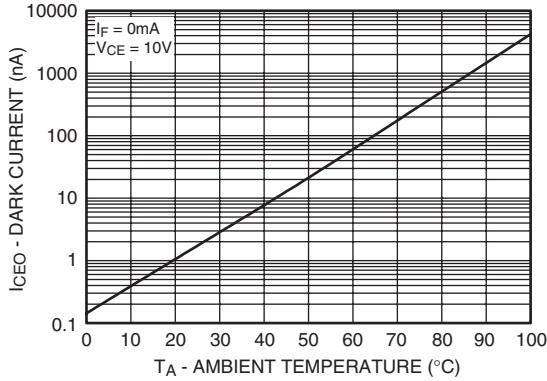

Fig. 8 Switching Time vs. Ambient Temperature

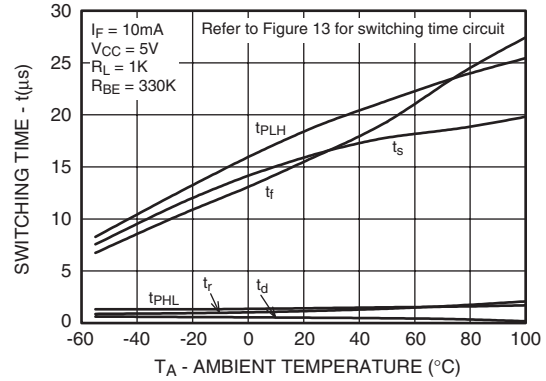

Fig. 9 Switching Time vs. Ambient Temperature

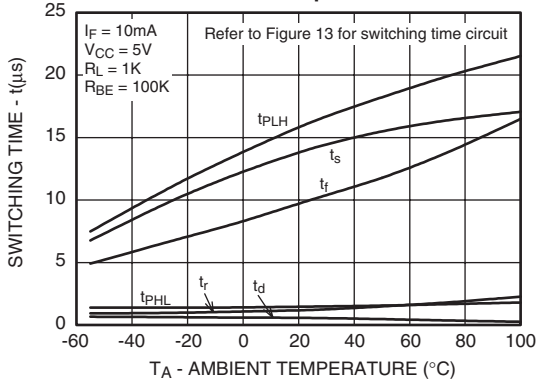

Fig. 10 Switching Time vs. Ambient Temperature

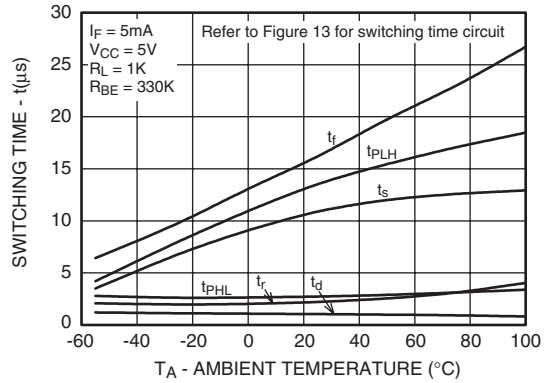

Fig. 11 Switching Time vs. Ambient Temperature

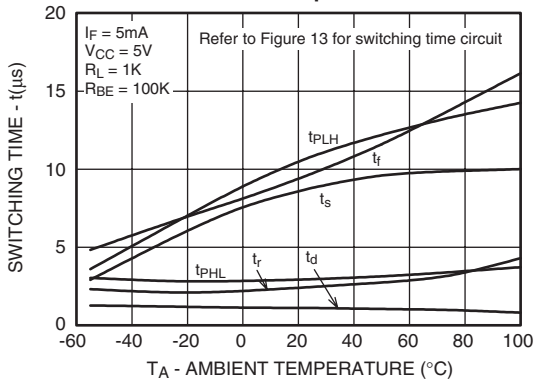
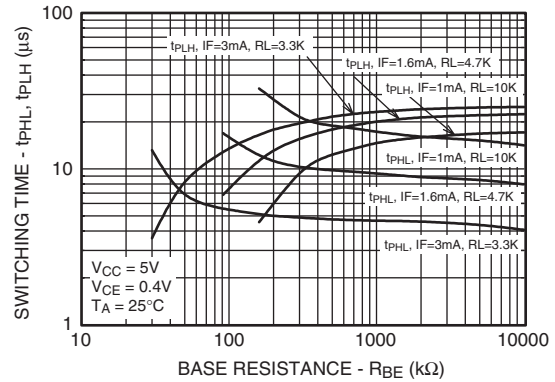

Fig. 12 Turn-on Time vs. Base-Emitter Resistance



MCT5200

MCT5201

MCT5210

MCT5211

TYPICAL ELECTRO-OPTICAL CHARACTERISTICS (TA = 25°C Unless Otherwise Specified)

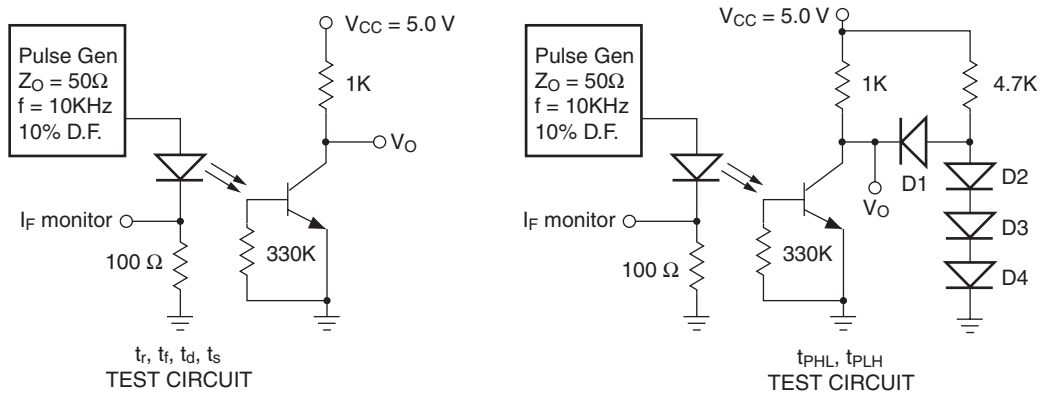

Figure 13.

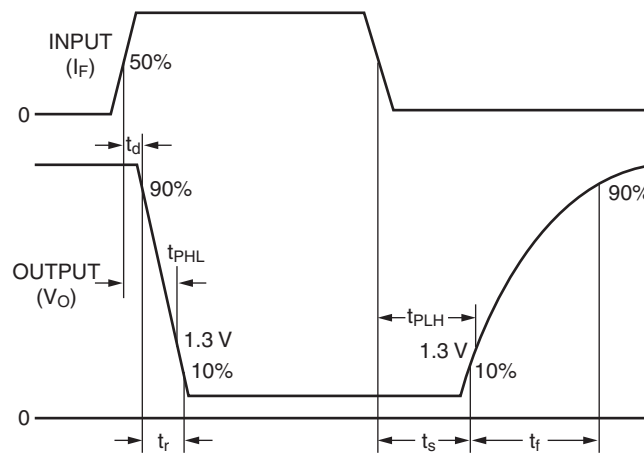

Figure 14. Switching Circuit Waveforms

MCT5200

MCT5201

MCT5210

MCT5211

ORDERING INFORMATION

Option	Order Entry Identifier	Description
S	.S	Surface Mount Lead Bend
SD	.SD	Surface Mount; Tape and Reel
W	.W	0.4" Lead Spacing
300	.300	VDE 0884
300W	.300W	VDE 0884, 0.4" Lead Spacing
3S	.3S	VDE 0884, Surface Mount
3SD	.3SD	VDE 0884, Surface Mount, Tape and Reel

MARKING INFORMATION

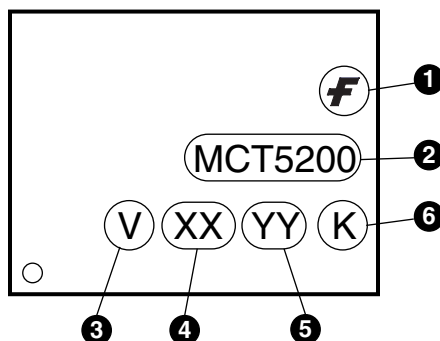

Definitions	
1	Fairchild logo
2	Device number
3	VDE mark (Note: Only appears on parts ordered with VDE option – See order entry table)
4	Two digit year code, e.g., '03'
5	Two digit work week ranging from '01' to '53'
6	Assembly package code

MCT5200

MCT5201

MCT5210

MCT5211

Carrier Tape Specifications

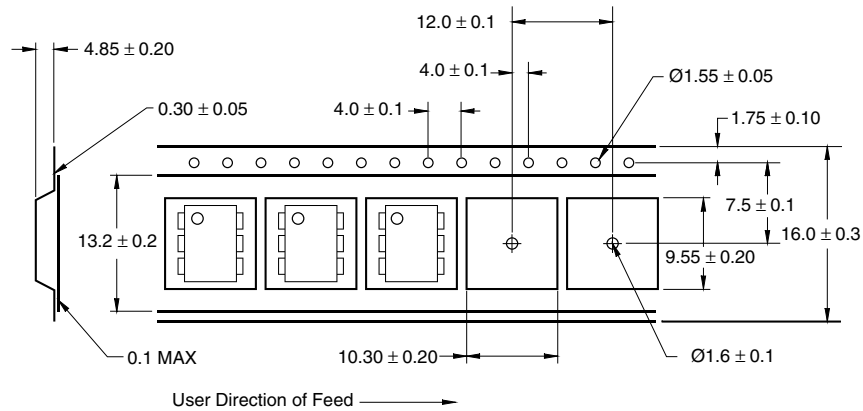

NOTE

All dimensions are in inches (millimeters)

Reflow Profile (Black Package, No Suffix)

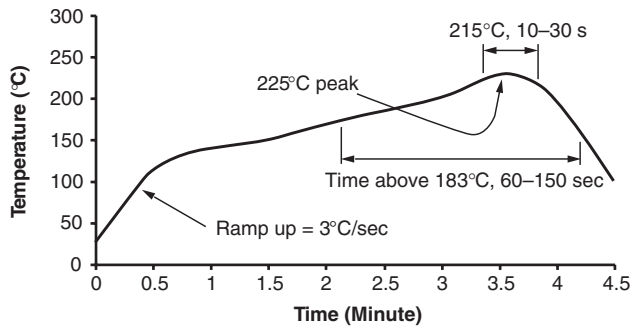

- Peak reflow temperature: 225°C (package surface temperature)
- Time of temperature higher than 183°C for 60–150 seconds
- One time soldering reflow is recommended

MCT5200

MCT5201

MCT5210

MCT5211

DISCLAIMER

FAIRCHILD SEMICONDUCTOR RESERVES THE RIGHT TO MAKE CHANGES WITHOUT FURTHER NOTICE TO ANY PRODUCTS HEREIN TO IMPROVE RELIABILITY, FUNCTION OR DESIGN. FAIRCHILD DOES NOT ASSUME ANY LIABILITY ARISING OUT OF THE APPLICATION OR USE OF ANY PRODUCT OR CIRCUIT DESCRIBED HEREIN; NEITHER DOES IT CONVEY ANY LICENSE UNDER ITS PATENT RIGHTS, NOR THE RIGHTS OF OTHERS.

LIFE SUPPORT POLICY

FAIRCHILD'S PRODUCTS ARE NOT AUTHORIZED FOR USE AS CRITICAL COMPONENTS IN LIFE SUPPORT DEVICES OR SYSTEMS WITHOUT THE EXPRESS WRITTEN APPROVAL OF THE PRESIDENT OF FAIRCHILD SEMICONDUCTOR CORPORATION. As used herein:

1. Life support devices or systems are devices or systems which, (a) are intended for surgical implant into the body, or (b) support or sustain life, and (c) whose failure to perform when properly used in accordance with instructions for use provided in the labeling, can be reasonably expected to result in a significant injury of the user.
2. A critical component in any component of a life support device or system whose failure to perform can be reasonably expected to cause the failure of the life support device or system, or to affect its safety or effectiveness.