

SERIES: MD-XXS | **DESCRIPTION:** MINI DIN CONNECTOR

FEATURES

- PCB mount
- right angle
- non-shielded

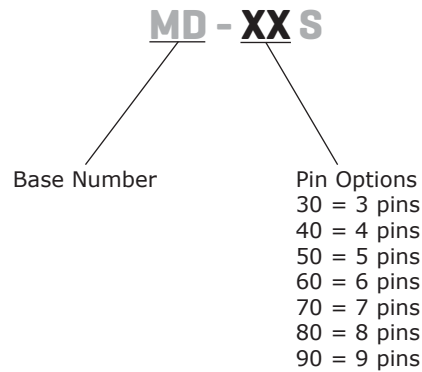

PART NUMBER KEY

SPECIFICATIONS

| parameter | conditions/description | min | typ | max | units |
|-----------------------|-------------------------|-----|-----------|--------|------------|
| rated input voltage | | | 100 12 | | Vac Vdc |
| rated input current | at 100 Vac at 12 Vdc | | | 1 2 | A A |
| contact resistance | | | | 30 | mΩ |
| insulation resistance | at 250 Vdc | 50 | | | MΩ |
| voltage withstand | for 1 minute | | | 250 | Vac |
| insertion force | | 1 | | 4.5 | kg |
| withdrawl force | | 0.8 | | 3 | kg |
| operating temperature | | -40 | | 85 | °C |
| life | | | 1,000 | | cycles |

MECHANICAL DRAWINGS

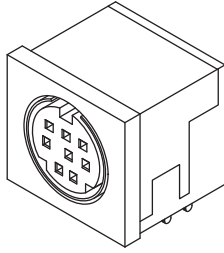
units: mm[inches]

TOLERANCE: ±0.2mm



| | MATERIAL | PLATING |
|-------------------------|-----------------|---------|
| earth terminal | brass | tin |
| contact terminals (1~8) | phosphor bronze | silver |
| housing | PBT | |

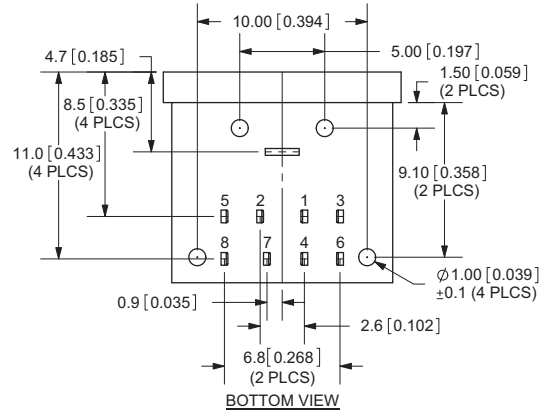
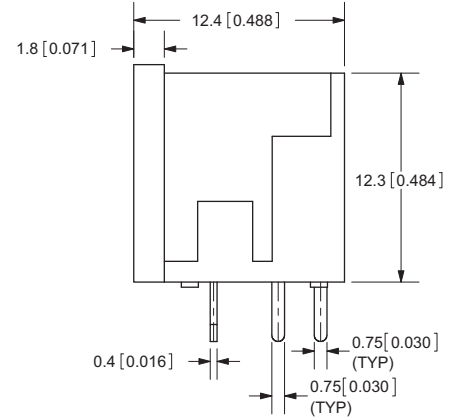
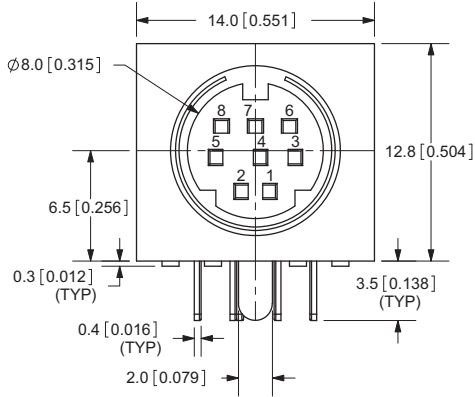

MD-30S

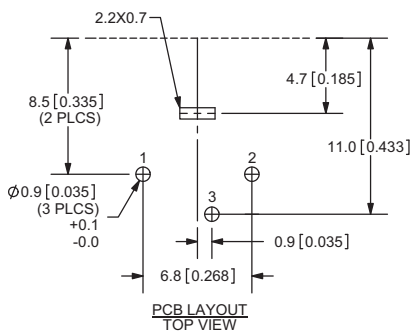
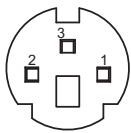

MD-40S

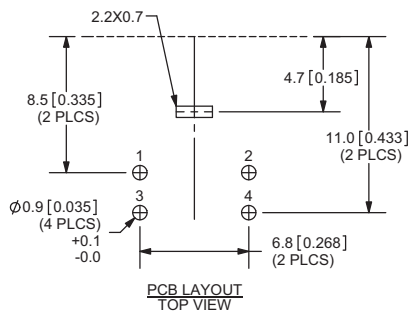
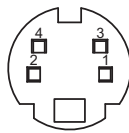

MD-50S

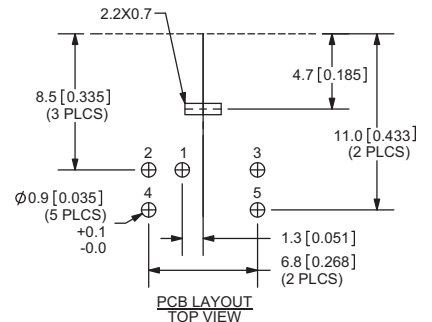
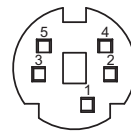

MD-60S

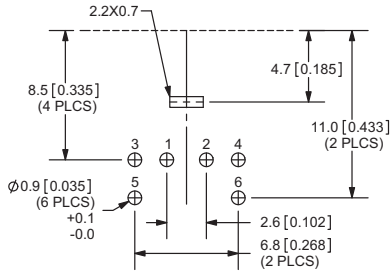
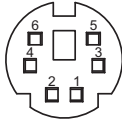

PCB LAYOUT TOP VIEW

MD-70S

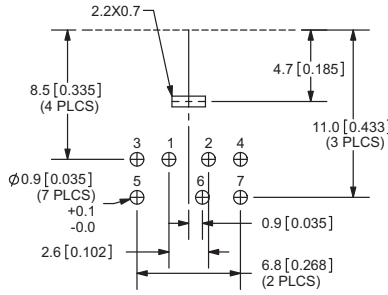
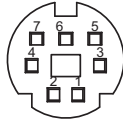

PCB LAYOUT TOP VIEW

MD-80S

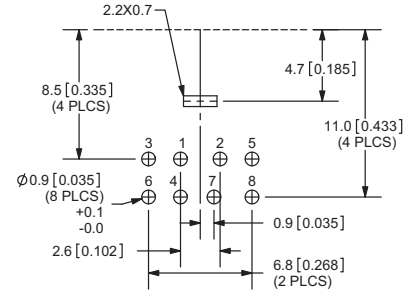
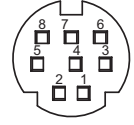

PCB LAYOUT TOP VIEW

MD-90S

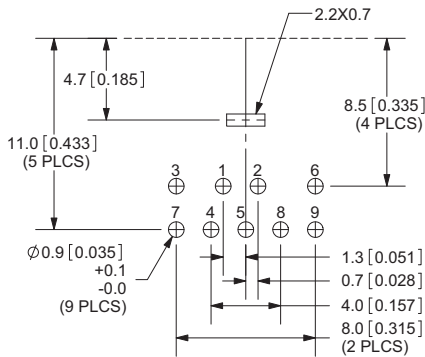
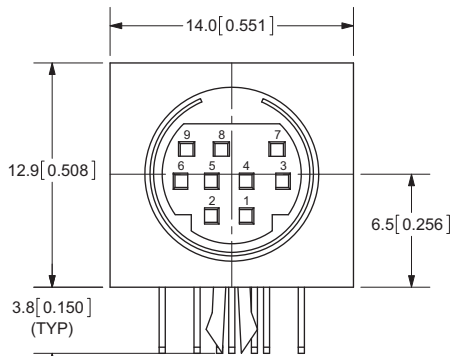
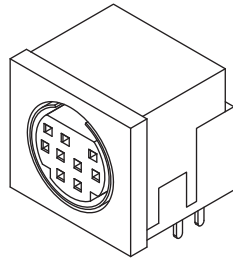

PCB LAYOUT TOP VIEW

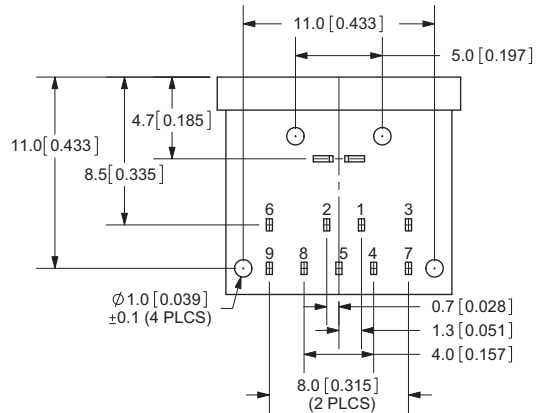
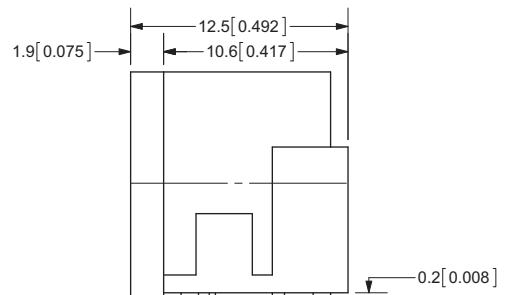

REVISION HISTORY

| rev. | description | date |
|------|----------------------|------------|
| 1.0 | initial release | 02/23/2006 |
| 1.01 | new template applied | 02/16/2012 |
| 1.02 | housing updates | 03/29/2012 |

The revision history provided is for informational purposes only and is believed to be accurate.



Headquarters
20050 SW 112th Ave.
Tualatin, OR 97062
800.275.4899

Fax 503.612.2383
cui.com
techsupport@cui.com

CUI offers a one (1) year limited warranty. Complete warranty information is listed on our website.

CUI reserves the right to make changes to the product at any time without notice. Information provided by CUI is believed to be accurate and reliable. However, no responsibility is assumed by CUI for its use, nor for any infringements of patents or other rights of third parties which may result from its use.

CUI products are not authorized or warranted for use as critical components in equipment that requires an extremely high level of reliability. A critical component is any component of a life support device or system whose failure to perform can be reasonably expected to cause the failure of the life support device or system, or to affect its safety or effectiveness.