



Micro Commercial Components



Micro Commercial Components  
 20736 Marilla Street Chatsworth  
 CA 91311  
 Phone: (818) 701-4933  
 Fax: (818) 701-4939

**MD100C08D1**  
**MD100C12D1**  
**MD100C16D1**  
**MD100C18D1**

## Features

- Lead Free Finish/RoHS Compliant (NOTE 1) ("P" Suffix designates RoHS Compliant. See ordering information)
- Blocking Voltage: 800 to 1800V
- Heat transfer through aluminum oxide DBC ceramic isolated metal baseplate
- Glass passivated chip

## Applications

- Non-controllable rectifiers for AC/AC converters
- Line rectifiers for transistorized AC motor controllers
- Field supply for DC motors



**100 Amp**  
**GLASS PASSIVATED**  
**RECTIFIER DIODE**  
**MODULES**  
**800~1800 Volts**

D1

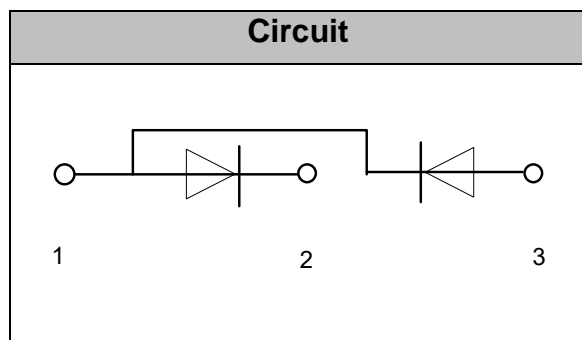
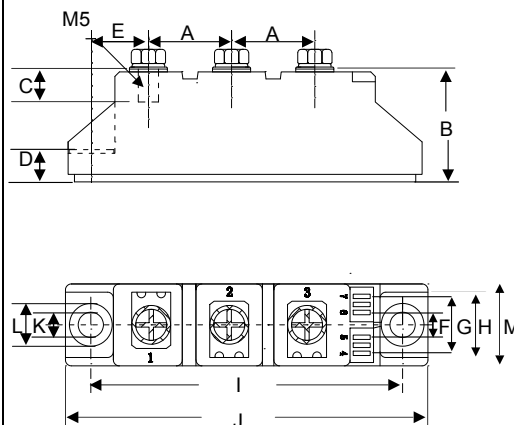

DIM	INCHES		MM		NOTE
	MIN	MAX	MIN	MAX	
A	.776	.799	19.70	20.30	
B	1.169	1.193	29.70	30.30	
C	.343	.366	8.70	9.30	
D	.323	.346	8.20	8.80	
E	.602	.622	15.30	15.80	
F	.224	.248	5.70	6.30	
G	.539	.563	13.70	14.30	
H	.657	.681	16.70	17.30	
I	3.138	3.161	79.70	80.30	
J	3.650	3.673	92.70	93.30	
K		.256		6.50	∅
L	.421	.445	10.70	11.30	
M	.815	.839	20.70	21.30	

### Module Type

TYPE	VRRM	VRSM
MD100C08D1	800V	900V
MD100C12D1	1200V	1300V
MD100C16D1	1600V	1700V
MD100C18D1	1800V	1900V

### Maximum Ratings

Symbol	Conditions	Values	Units
IFAV	Single phase ,half wave 180° conduction Tc=109°C	100	A
IFSM	t=10mS Tvj =45°C	2500	A
i <sup>2</sup> t	t=10mS Tvj =45°C	31250	A <sup>2</sup> s
Visol	a.c.50HZ;r.m.s.;1min	3000	V
Tvj		-40 to +150	°C
Tstg		-40 to +125	°C
Mt	To terminals(M5)	3±15%	Nm
Ms	To heatsink(M6)	5±15%	Nm
Weight	Module (Approximately)	100	g

### Thermal Characteristics

Symbol	Conditions	Values	Units
Rth(j-c)	Per diode	0.35	°C/W
Rth(c-s)	Module	0.1	°C/W

### Electrical Characteristics

Symbol	Conditions	Values			Units
		Min.	Typ.	Max.	
VFM	T=25°C IF =300A	—	1.20	1.40	V
IRD	Tvj=150°C VRD=VRRM	—	—	5	mA

**Performance Curves**

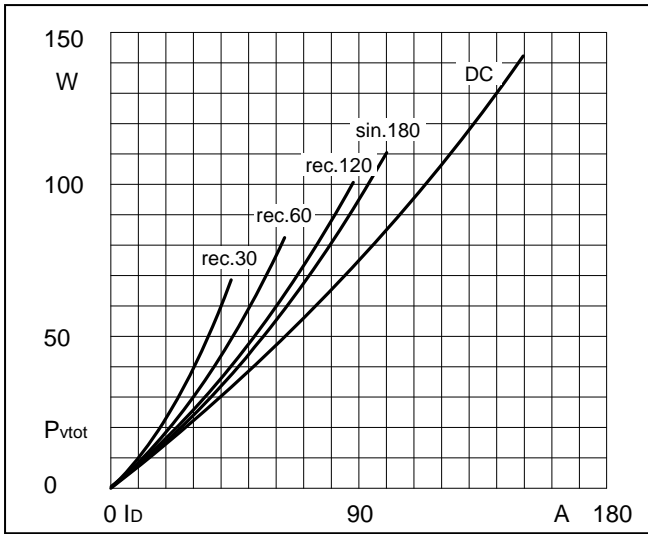

**Fig1. Power dissipation**

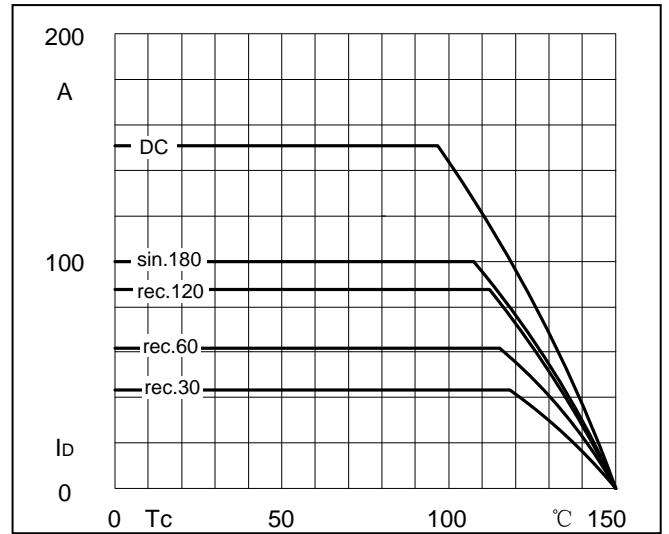

**Fig2. Forward Current Derating Curve**

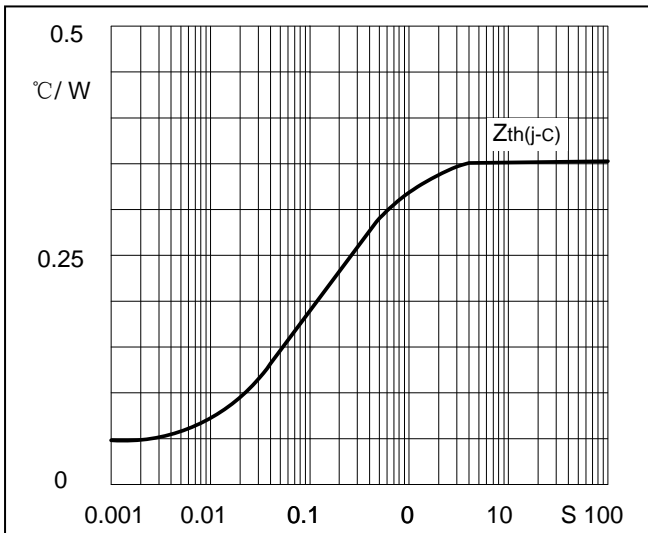

**Fig3. Transient thermal impedance**

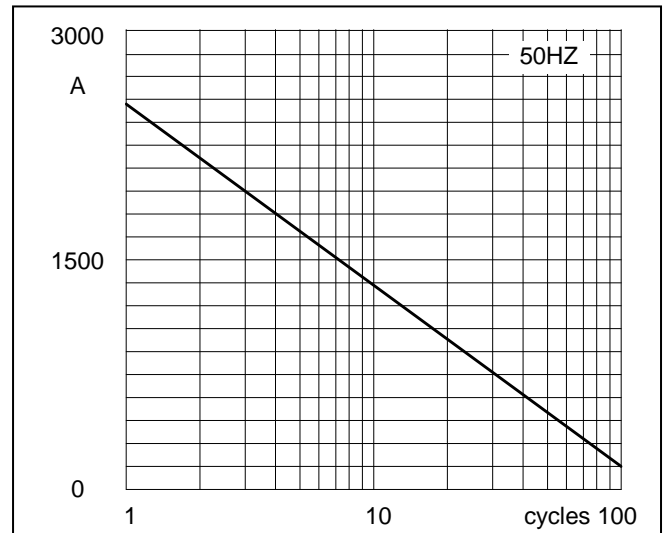

**Fig4. Max Non-Repetitive Forward Surge Current**

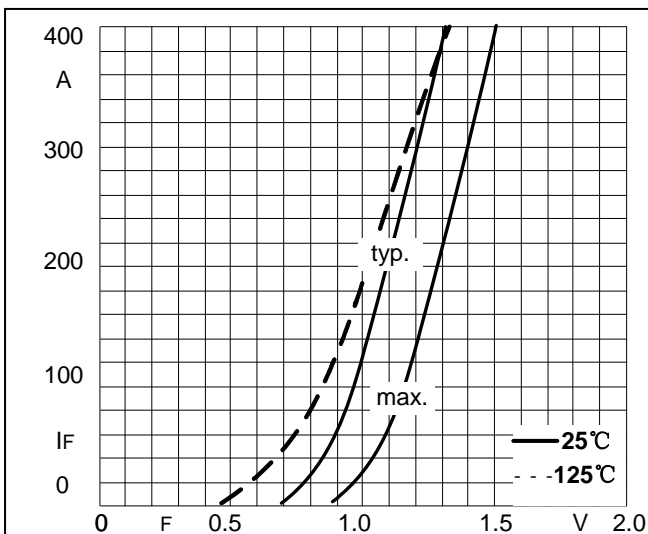

**Fig5. Forward Characteristics**



Micro Commercial Components

## Ordering Information :

Device	Packing
Part Number-BP	Bulk: 10PCS/BOX ;100PCS/CTN

### \*\*\*IMPORTANT NOTICE\*\*\*

**Micro Commercial Components Corp.** reserves the right to make changes without further notice to any product herein to make corrections, modifications , enhancements , improvements , or other changes . **Micro Commercial Components Corp .** does not assume any liability arising out of the application or use of any product described herein; neither does it convey any license under its patent rights ,nor the rights of others . The user of products in such applications shall assume all risks of such use and will agree to hold **Micro Commercial Components Corp .** and all the companies whose products are represented on our website, harmless against all damages.

### \*\*\*LIFE SUPPORT\*\*\*

MCC's products are not authorized for use as critical components in life support devices or systems without the express written approval of Micro Commercial Components Corporation.

### \*\*\*CUSTOMER AWARENESS\*\*\*

Counterfeiting of semiconductor parts is a growing problem in the industry. Micro Commercial Components (MCC) is taking strong measures to protect ourselves and our customers from the proliferation of counterfeit parts. MCC strongly encourages customers to purchase MCC parts either directly from MCC or from Authorized MCC Distributors who are listed by country on our web page cited below. Products customers buy either from MCC directly or from Authorized MCC Distributors are genuine parts, have full traceability, meet MCC's quality standards for handling and storage. **MCC will not provide any warranty coverage or other assistance for parts bought from Unauthorized Sources.** MCC is committed to combat this global problem and encourage our customers to do their part in stopping this practice by buying direct or from authorized distributors.

[www.mccsemi.com](http://www.mccsemi.com)