

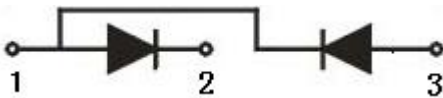

# MDC100



Power Diode Module MDC100 series are designed for various rectifier circuits.

MDC100 has two diode chips connected in series in 25mm width package and the mounting base is electrically isolated from elements for simple heatsink construction.

Wide voltage rating up to 1600V is available for various input voltages.

Isolated mounting base

Two elements in a package for simple (single and three phase) bridge connections

High surge current capability

### (Applications)

Various rectifiers Battery chargers DC motor drives

### Module Type

TYPE	VRRM	VRSM
MDC100-02	200V	240V
MDC100-04	400V	480V
MDC100-06	600V	720V
MDC100-08	800V	960V
MDC100-10	1000V	1100V
MDC100-12	1200V	1300V
MDC100-14	1400V	1500V
MDC100-16	1600V	1700V

### Maximum Ratings

Symbol	Conditions	Values	Units
$I_{F(AV)}$	$T_c=85^\circ\text{C}$	100	A
$I_{FSM}$	$T_{vj}=45^\circ\text{C}$ $t=10\text{ms}$ (50HZ), sine	2000	A
$i^2t$	$T_{vj}=45^\circ\text{C}$ $t=10\text{ms}$ (50HZ), sine	20000	$\text{A}^2\text{S}$
Viso	a.c.50HZ;r.m.s.;1min	2500	V
$T_{vj}$		-40 to 150	$^\circ\text{C}$
$T_{stg}$		-40 to 125	$^\circ\text{C}$
Weight	Module (Approximately)	180	g

### Thermal Characteristics

Symbol	Conditions	Values	Units
$R_{th(j-c)}$	Per module	0.3	$^\circ\text{C}/\text{W}$

### Electrical Characteristics

Symbol	Conditions	Values	Units
VFM	$T=25^\circ\text{C}$ $I_{FM}=300\text{A}$	1.70	V
IRD	$T_{vj}=25^\circ\text{C}$ $VRD=VRRM$	$\leq 0.5$	mA
	$T_{vj}=150^\circ\text{C}$ $VRD=VRRM$	$\leq 10$	mA



# MDC100

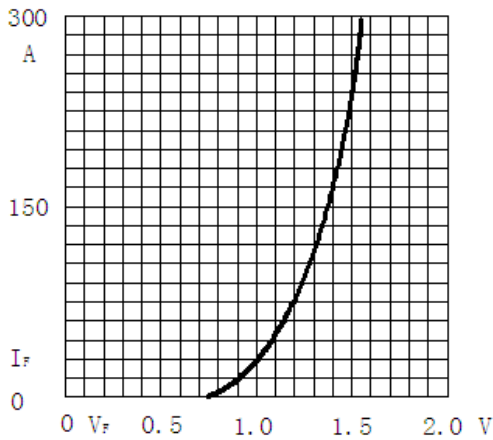

Fig1. Forward Characteristics

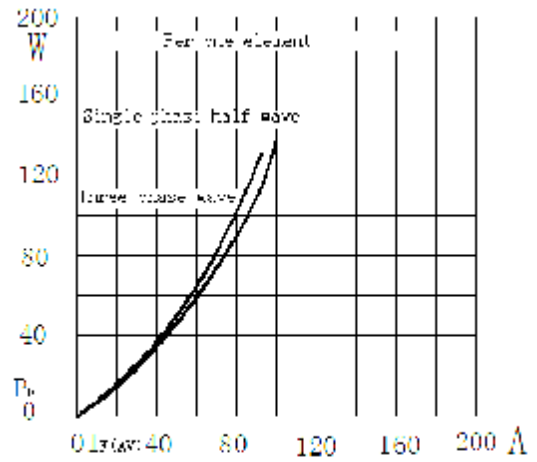

Fig2. Power dissipation

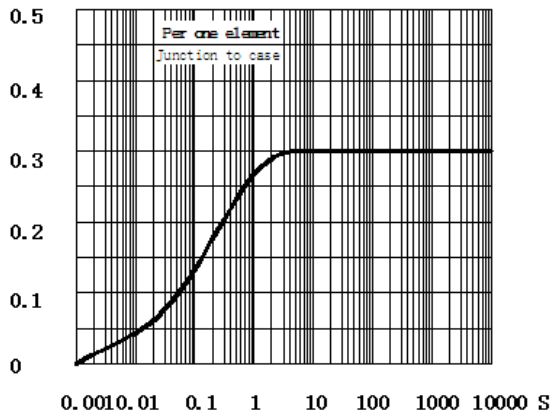

Fig3. Transient thermal impedance

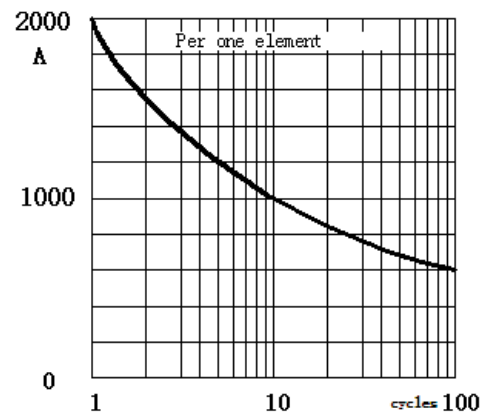

Fig4. Max Non-Repetitive Forward Surge Current

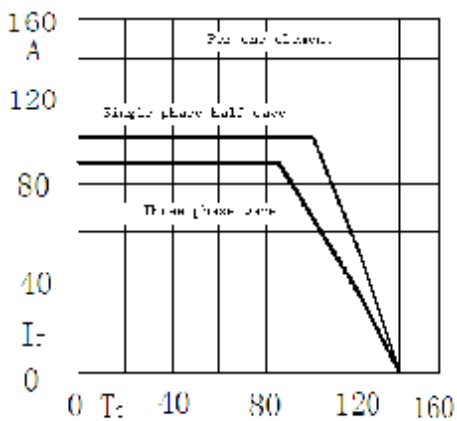
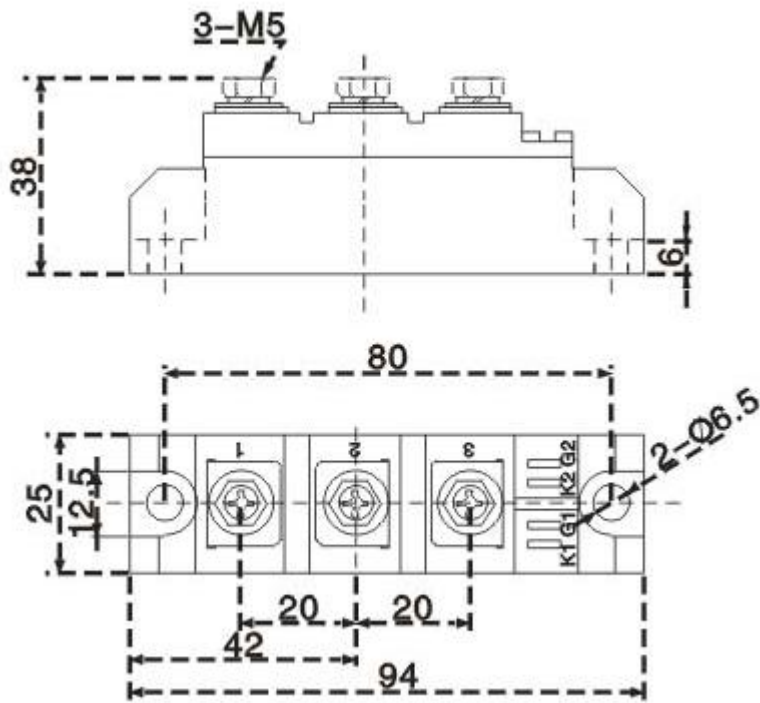

Fig5. Forward Current Derating Curve



# MDC100



Dimensions in mm