

# Standard Rectifier Module

$$V_{RRM} = 2 \times 1800 \text{ V}$$

$$I_{FAV} = 224 \text{ A}$$

$$V_F = 1.07 \text{ V}$$

Phase leg

Part number

**MDD200-18N1**

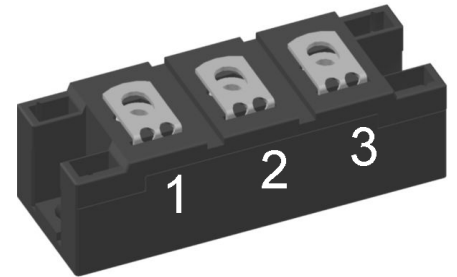

Backside: isolated

 E72873



### Features / Advantages:

- Package with DCB ceramic
- Improved temperature and power cycling
- Planar passivated chips
- Very low forward voltage drop
- Very low leakage current

### Applications:

- Diode for main rectification
- For single and three phase bridge configurations
- Supplies for DC power equipment
- Input rectifiers for PWM inverter
- Battery DC power supplies
- Field supply for DC motors

### Package: Y4

- Isolation Voltage: 3600 V~
- Industry standard outline
- RoHS compliant
- Height: 30 mm
- Base plate: DCB ceramic
- Reduced weight
- Advanced power cycling

### Disclaimer Notice

Information furnished is believed to be accurate and reliable. However, users should independently evaluate the suitability of and test each product selected for their own applications. Littelfuse products are not designed for, and may not be used in, all applications. Read complete Disclaimer Notice at [www.littelfuse.com/disclaimer-electronics](http://www.littelfuse.com/disclaimer-electronics).

Rectifier				Ratings			
Symbol	Definition	Conditions		min.	typ.	max.	Unit
$V_{RSM}$	max. non-repetitive reverse blocking voltage					1900	V
$V_{RRM}$	max. repetitive reverse blocking voltage					1800	V
$I_R$	reverse current	$V_R = 1800$ V		$T_{VJ} = 25^\circ\text{C}$		1	mA
		$V_R = 1800$ V		$T_{VJ} = 150^\circ\text{C}$		20	mA
$V_F$	forward voltage drop	$I_F = 300$ A		$T_{VJ} = 25^\circ\text{C}$		1.16	V
		$I_F = 600$ A				1.39	V
		$I_F = 300$ A		$T_{VJ} = 125^\circ\text{C}$		1.07	V
		$I_F = 600$ A				1.36	V
$I_{FAV}$	average forward current	$T_C = 100^\circ\text{C}$		$T_{VJ} = 150^\circ\text{C}$		224	A
$I_{F(RMS)}$	RMS forward current	180° sine	d = 0.5			350	A
$V_{FO}$	threshold voltage	} for power loss calculation only		$T_{VJ} = 150^\circ\text{C}$		0.80	V
$r_F$	slope resistance					0.6	mΩ
$R_{thJC}$	thermal resistance junction to case					0.13	K/W
$R_{thCH}$	thermal resistance case to heatsink				0.08		K/W
$P_{tot}$	total power dissipation			$T_C = 25^\circ\text{C}$		960	W
$I_{FSM}$	max. forward surge current	t = 10 ms; (50 Hz), sine		$T_{VJ} = 45^\circ\text{C}$		10.5	kA
		t = 8,3 ms; (60 Hz), sine		$V_R = 0$ V		11.3	kA
		t = 10 ms; (50 Hz), sine		$T_{VJ} = 150^\circ\text{C}$		8.93	kA
		t = 8,3 ms; (60 Hz), sine		$V_R = 0$ V		9.64	kA
$I^2t$	value for fusing	t = 10 ms; (50 Hz), sine		$T_{VJ} = 45^\circ\text{C}$		551.3	kA <sup>2</sup> s
		t = 8,3 ms; (60 Hz), sine		$V_R = 0$ V		535.0	kA <sup>2</sup> s
		t = 10 ms; (50 Hz), sine		$T_{VJ} = 150^\circ\text{C}$		398.3	kA <sup>2</sup> s
		t = 8,3 ms; (60 Hz), sine		$V_R = 0$ V		386.6	kA <sup>2</sup> s
$C_J$	junction capacitance	$V_R = 1100$ V; f = 1 MHz		$T_{VJ} = 25^\circ\text{C}$		230	pF



Package Y4				Ratings			
Symbol	Definition	Conditions	min.	typ.	max.	Unit	
$I_{RMS}$	RMS current	per terminal			300	A	
$T_{VJ}$	virtual junction temperature		-40		150	°C	
$T_{op}$	operation temperature		-40		125	°C	
$T_{stg}$	storage temperature		-40		125	°C	
<b>Weight</b>					150	g	
$M_D$	mounting torque		2.25		2.75	Nm	
$M_T$	terminal torque		4.5		5.5	Nm	
$d_{Spp/App}$	creepage distance on surface   striking distance through air	terminal to terminal	14.0	10.0		mm	
$d_{Spb/Apb}$		terminal to backside	16.0	16.0		mm	
$V_{ISOL}$	isolation voltage	t = 1 second			3600	V	
		t = 1 minute	50/60 Hz, RMS; $I_{ISOL} \leq 1$ mA		3000	V	

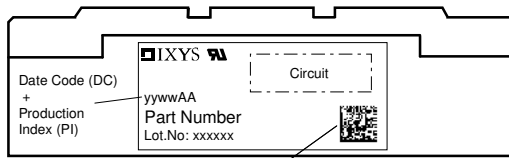

Data Matrix: part no. (1-19), DC + PI (20-25), lot.no.# (26-31), blank (32), serial no.# (33-36)

Ordering	Ordering Number	Marking on Product	Delivery Mode	Quantity	Code No.
Standard	MDD200-18N1	MDD200-18N1	Box	6	499641

**Equivalent Circuits for Simulation**

\* on die level

$T_{VJ} = 150^{\circ}C$



**Rectifier**

$V_{0\ max}$	threshold voltage	0.8	V
$R_{0\ max}$	slope resistance *	0.4	mΩ



**Outlines Y4**

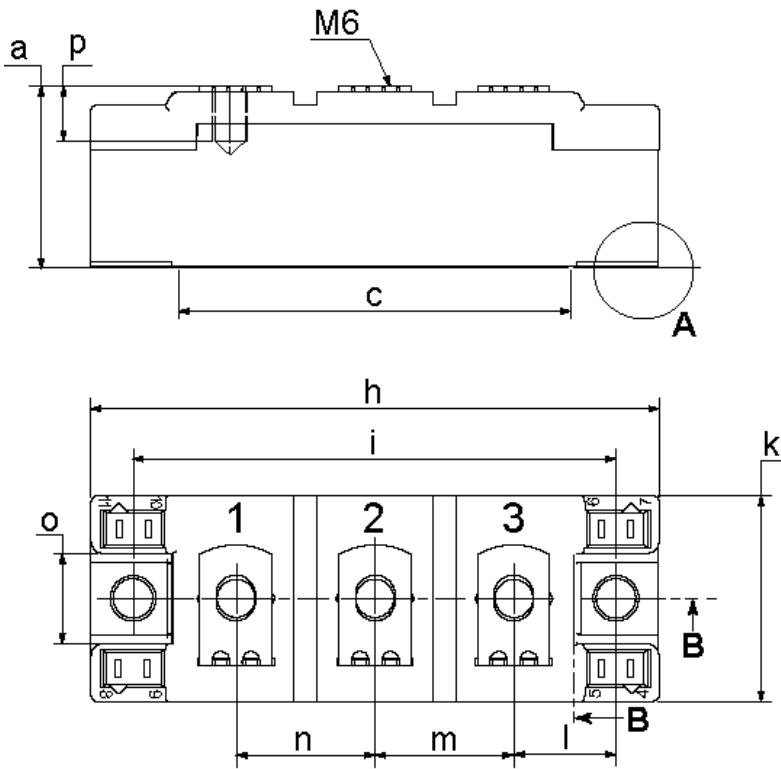

Dim.	MIN [mm]	MAX [mm]	MIN [inch]	MAX [inch]
a	30.0	30.6	1.181	1.205
b	typ. 0.25		typ. 0.010	
c	64.0	65.0	2.520	2.559
d	6.5	7.0	0.256	0.275
e	4.9	5.1	0.193	0.201
h	93.5	94.5	3.681	3.720
i	79.5	80.5	3.130	3.169
k	33.4	34.0	1.315	1.339
l	16.7	17.3	0.657	0.681
m	22.7	23.3	0.894	0.917
n	22.7	23.3	0.894	0.917
o	14.0	15.0	0.551	0.591
p	typ. 10.5		typ. 0.413	

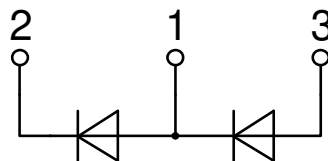
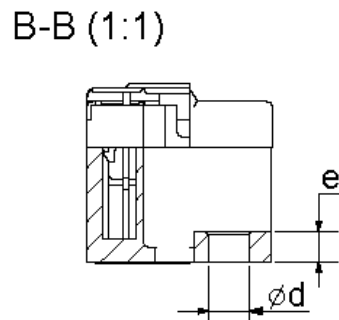
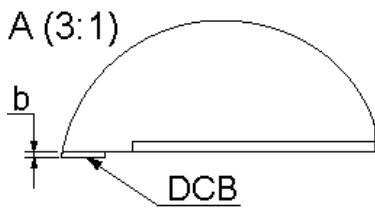



**Rectifier**

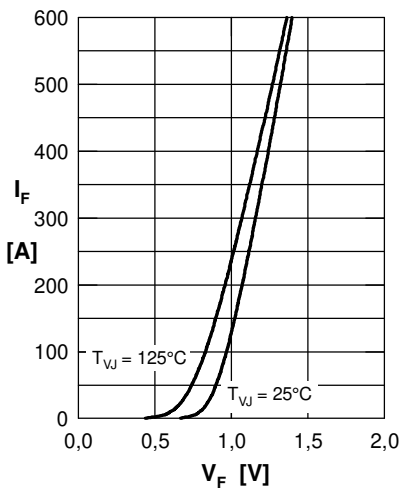

Fig. 1 Forward current versus voltage drop

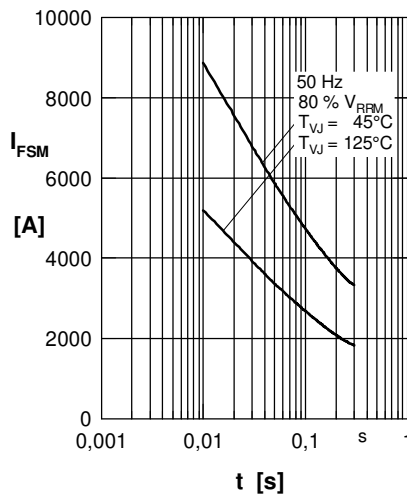

Fig. 2 Surge overload current  
 $I_{FSM}$ : Crest value,  $t$ : duration

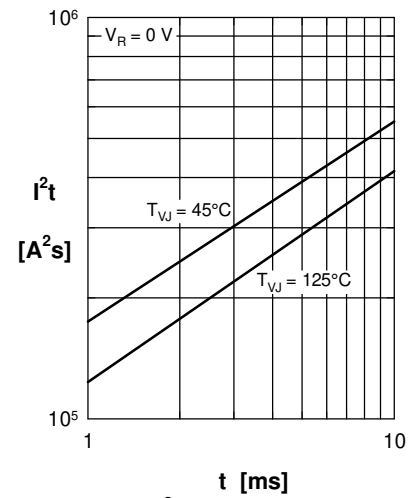

Fig. 3  $I^2t$  versus time (1-10 ms)

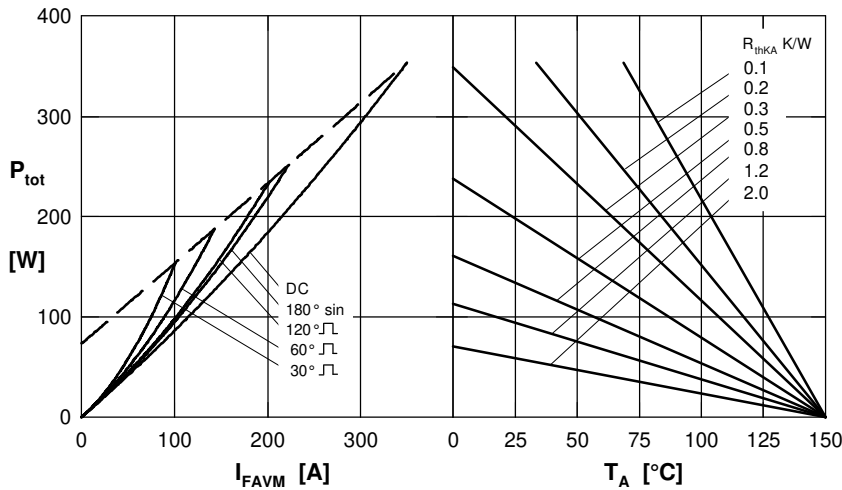

Fig.4 Power dissipation versus forward current and ambient temperature (per diode)

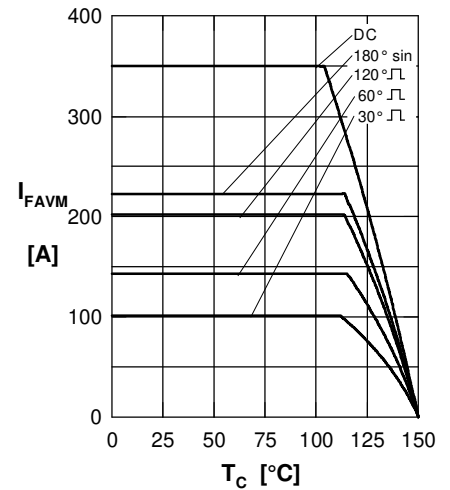

Fig. 5 Maximum forward current at case temperature

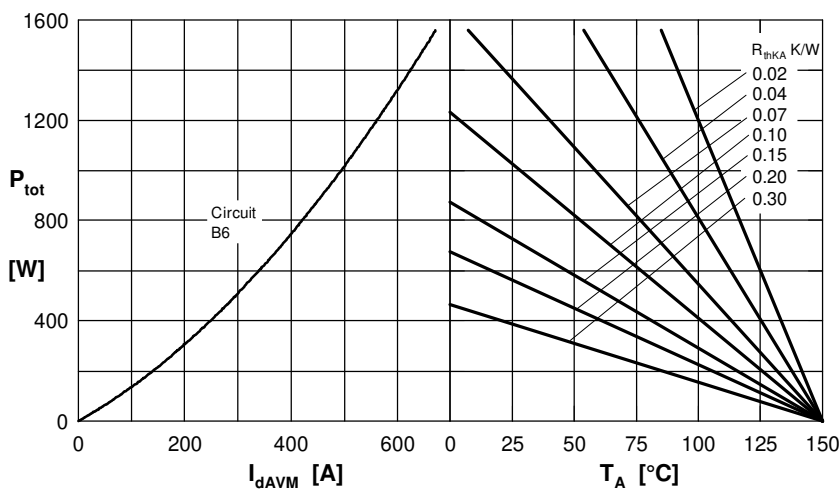

Fig.6 Three phase rectifier bridge: Power dissipation versus direct output current and ambient temperature

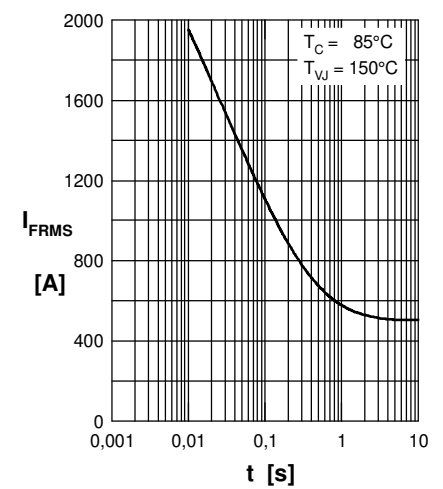
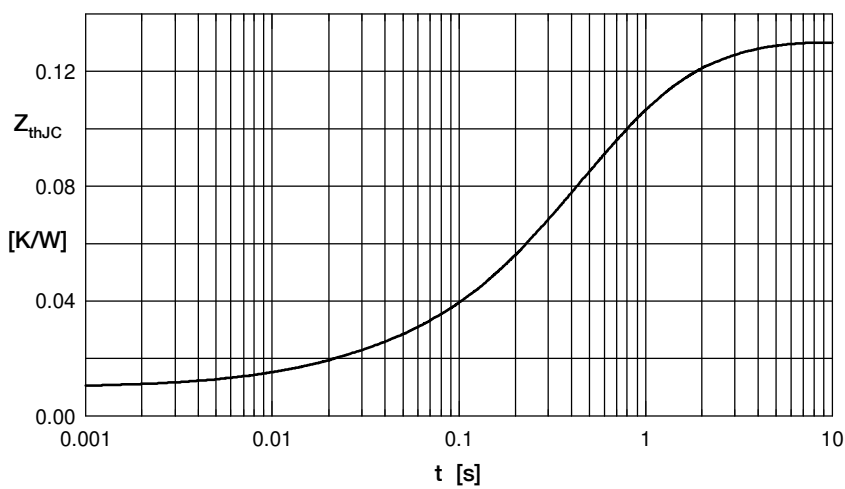

Fig. 7 Rated RMS current versus time (360° conduction)



**Rectifier**



Constants for  $Z_{thJC}$  calculation:

i	$R_{thi}$ [K/W]	$t_i$ [s]
1	0.0100	0.00014
2	0.0065	0.019
3	0.0250	0.180
4	0.0615	0.520
5	0.0270	1.600

Fig. 8 Transient thermal impedance junction to case