

Fast Recovery Epitaxial Diode (FRED) Module

MEK 350-02 DA

$V_{RRM} = 200\text{ V}$
 $I_{FAVM} = 356\text{ A}$
 $t_{rr} = 150\text{ ns}$

V_{RSM}	V_{RRM}	Type
V	V	
200	200	MEK 350-02DA

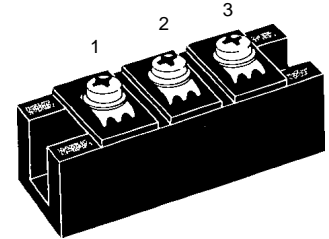
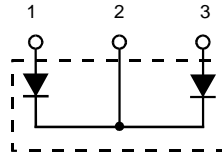

Symbol	Test Conditions	Maximum Ratings	
I_{FRMS}	$T_C = 75^\circ\text{C}$	503	A
I_{FAVM} ①	$T_C = 75^\circ\text{C}$; rectangular, $d = 0.5$	356	A
I_{FRM}	$t_p < 10\ \mu\text{s}$; rep. rating, pulse width limited by T_{VJM}	1800	A
I_{FSM}	$T_{VJ} = 45^\circ\text{C}$; $t = 10\text{ ms}$ (50 Hz), sine	2400	A
	$t = 8.3\text{ ms}$ (60 Hz), sine	2640	A
	$T_{VJ} = 150^\circ\text{C}$; $t = 10\text{ ms}$ (50 Hz), sine	2160	A
	$t = 8.3\text{ ms}$ (60 Hz), sine	2380	A
I^2t	$T_{VJ} = 45^\circ\text{C}$; $t = 10\text{ ms}$ (50 Hz), sine	28800	A ² s
	$t = 8.3\text{ ms}$ (60 Hz), sine	29300	A ² s
	$T_{VJ} = 150^\circ\text{C}$; $t = 10\text{ ms}$ (50 Hz), sine	23300	A ² s
	$t = 8.3\text{ ms}$ (60 Hz), sine	23800	A ² s
T_{VJ}		-40...+150	°C
T_{stg}		-40...+125	°C
T_{Smax}		110	°C
P_{tot}	$T_C = 25^\circ\text{C}$	875	W
V_{ISOL}	50/60 Hz, RMS $t = 1\text{ min}$	3000	V~
	$I_{ISOL} \leq 1\text{ mA}$ $t = 1\text{ s}$	3600	V~
M_d	Mounting torque (M6)	2.25-2.75/20-25 Nm/lb.in.	
	Terminal connection torque (M6)	4.50-5.50/40-48 Nm/lb.in.	
d_s	Creeping distance on surface	12.7	mm
d_A	Strike distance through air	9.6	mm
a	Maximum allowable acceleration	50	m/s ²
Weight		150	g

Features

- International standard package with DCB ceramic base plate
- Planar passivated chips
- Short recovery time
- Low switching losses
- Soft recovery behaviour
- Isolation voltage 3600 V~
- UL registered E 72873

Applications

- Antiparallel diode for high frequency switching devices
- Free wheeling diode in converters and motor control circuits
- Inductive heating and melting
- Uninterruptible power supplies (UPS)
- Ultrasonic cleaners and welders

Advantages

- High reliability circuit operation
- Low voltage peaks for reduced protection circuits
- Low noise switching
- Low losses

Symbol	Test Conditions	Characteristic Values (per diode)		
		typ.	max.	
I_R	$T_{VJ} = 25^\circ\text{C}$ $V_R = V_{RRM}$		3 mA	
	$T_{VJ} = 25^\circ\text{C}$ $V_R = 0.8 \cdot V_{RRM}$		2 mA	
	$T_{VJ} = 125^\circ\text{C}$ $V_R = 0.8 \cdot V_{RRM}$		80 mA	
V_F	$I_F = 150\text{ A}$; $T_{VJ} = 125^\circ\text{C}$		0.80 V	
	$T_{VJ} = 25^\circ\text{C}$		0.98 V	
	$I_F = 260\text{ A}$; $T_{VJ} = 125^\circ\text{C}$		0.92 V	
	$T_{VJ} = 25^\circ\text{C}$		1.07 V	
V_{TO}	For power-loss calculations only		0.53 V	
r_T			1.29 mΩ	
R_{thJH}	DC current		0.228 K/W	
R_{thJC}	DC current		0.143 K/W	
t_{rr} I_{RM}	$I_F = 300\text{ A}$ $V_R = 100\text{ V}$ $-di/dt = 200\text{ A}/\mu\text{s}$	150	$T_{VJ} = 100^\circ\text{C}$	200 ns
			$T_{VJ} = 25^\circ\text{C}$	9 A
			$T_{VJ} = 100^\circ\text{C}$	15 A

① I_{FAVM} rating includes reverse blocking losses at T_{VJM} , $V_R = 0.6 V_{RRM}$, duty cycle $d = 0.5$
Data according to IEC 60747
IXYS reserves the right to change limits, test conditions and dimensions

Dimensions in mm (1 mm = 0.0394")

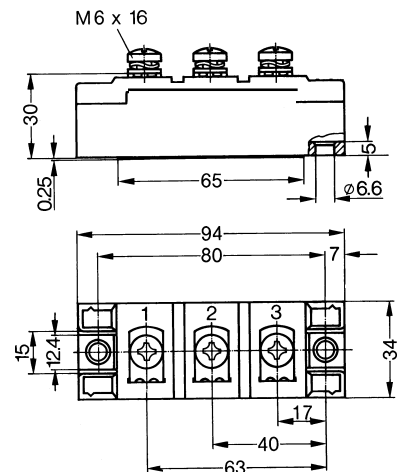

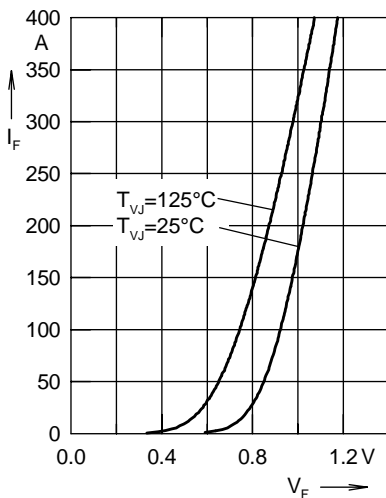
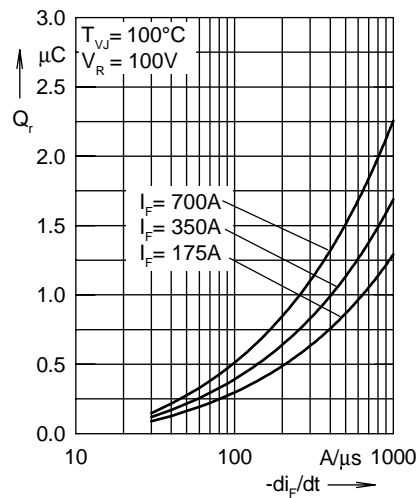
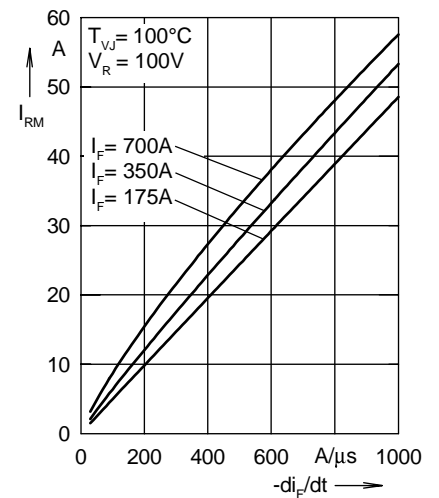
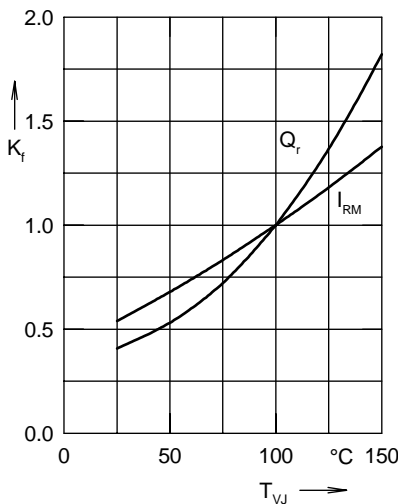
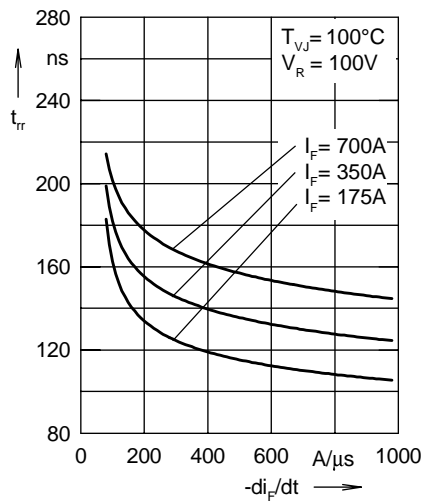
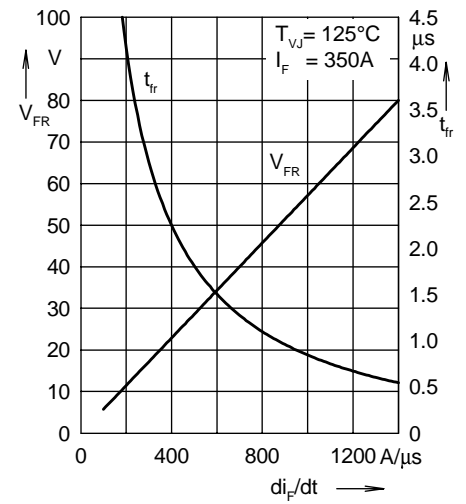
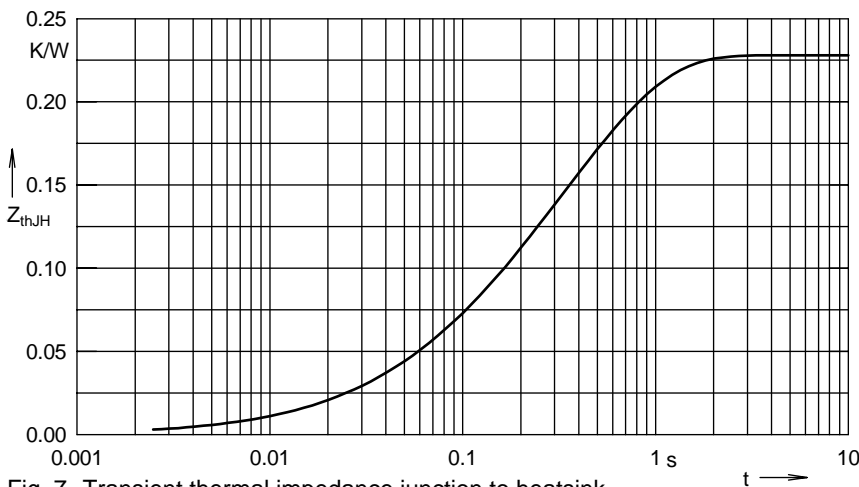

 Fig. 1 Forward current I_F versus voltage drop V_F per leg

 Fig. 2 Reverse recovery charge Q_r versus $-di_F/dt$

 Fig. 3 Peak reverse current I_{RM} versus $-di_F/dt$

 Fig. 4 Dynamic parameters Q_r , I_{RM} versus junction temperature T_{VJ}

 Fig. 5 Recovery time t_{rr} versus $-di_F/dt$

 Fig. 6 Peak forward voltage V_{FR} and t_{fr} versus di_F/dt

Fig. 7 Transient thermal impedance junction to heatsink

 Constants for Z_{thJS} calculation:

i	R_{thi} (K/W)	t_i (s)
1	0.002	0.08
2	0.008	0.024
3	0.054	0.112
4	0.164	0.464