

MITSUBISHI IGBT MODULES  
**MG800J1US52A**

HIGH POWER SWITCHING APPLICATIONS  
 MOTOR CONTROL APPLICATIONS

**MG800J1US52A**



**FEATURE**

- The electrodes are isolated from case.
- Enhancement-mode
- Integrates fault-signal output circuit in package. (Short-Circuit and Over-Current)
- UL Recognized Yellow Card No.E80276  
File No.E80271

**APPLICATION**

General purpose inverters, servo drives and motor controls

**OUTLINE DRAWING & EQUIVALENT CIRCUIT**

Dimensions in mm

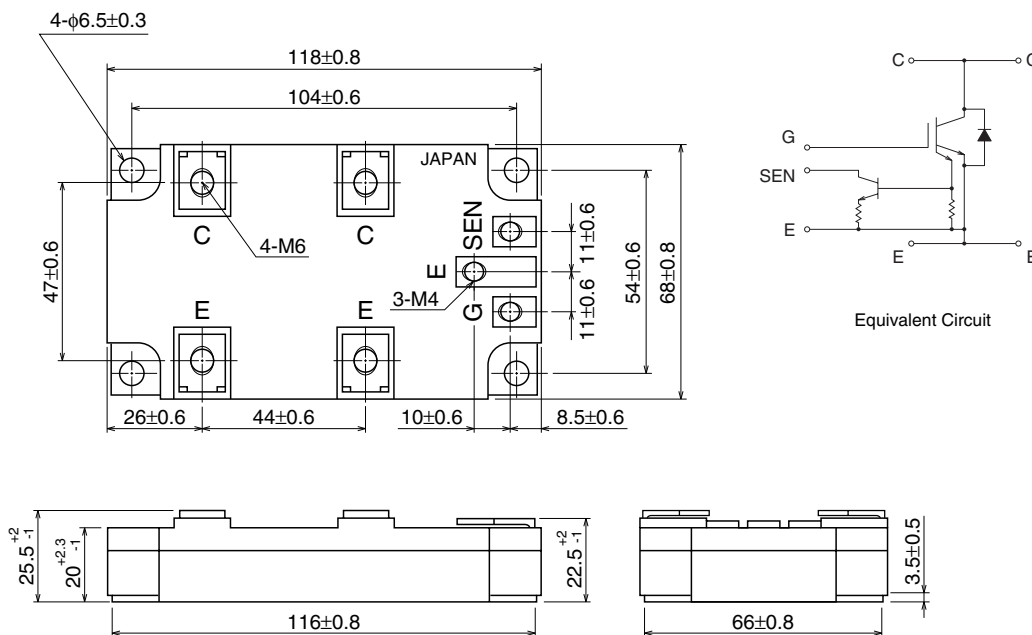

Weight: 420g

**MG800J1US52A**

**HIGH POWER SWITCHING APPLICATIONS  
MOTOR CONTROL APPLICATIONS**

**MAXIMUM RATINGS (Ta = 25°C)**

Symbol	Parameter		Conditions	Ratings	Unit
V <sub>CE</sub> S	Collector-emitter voltage			600	V
V <sub>GE</sub> S	Gate-emitter voltage			±20	V
V <sub>SE</sub> S	Sense-emitter voltage			40	V
I <sub>C</sub>	Collector current	DC		800	A
I <sub>CP</sub>		1ms		1600	
I <sub>F</sub>	Forward current	DC		800	A
I <sub>FM</sub>		1ms		1600	
P <sub>C</sub>	Collector power dissipation		T <sub>C</sub> = 25°C	2500	W
T <sub>j</sub>	Junction temperature			150	°C
T <sub>stg</sub>	Storage temperature range			-40 ~ 125	°C
V <sub>isol</sub>	Isolation voltage			2500 (AC 1 minute)	V
—	Screw	Terminal (M4/M6)		2/3	N • m
—	torque	Mounting		3	

**ELECTRICAL CHARACTERISTICS (Ta = 25°C)**

Symbol	Parameter	Test conditions	Limits			Unit	
			Min.	Typ.	Max.		
I <sub>GES</sub>	Gate leakage current	V <sub>GE</sub> = ±20V, V <sub>CE</sub> = 0	—	—	±500	nA	
I <sub>CES</sub>	Collector cut-off current	V <sub>CE</sub> = 600V, V <sub>GE</sub> = 0	—	—	4.0	mA	
V <sub>GE(off)</sub>	Gate-emitter cut-off voltage	I <sub>C</sub> = 800mA, V <sub>CE</sub> = 5V	5.5	7.0	8.0	V	
V <sub>CE(sat)</sub>	Collector-emitter saturation voltage	I <sub>C</sub> = 800A, T <sub>j</sub> = 25°C	—	2.1	2.7	V	
C <sub>ies</sub>	Input capacitance	V <sub>CE</sub> = 10V, V <sub>GE</sub> = 0, f = 1MHz	—	93000	—	pF	
t <sub>d(on)</sub>	Switching time	Turn-on delay time	—	0.3	—	μs	
t <sub>r</sub>		Rise time	Inductive load	—	0.25		—
t <sub>on</sub>		Turn-on time	V <sub>CC</sub> = 300V	—	0.55		—
t <sub>d(off)</sub>		Turn-off delay time	I <sub>C</sub> = 800A	—	0.62		—
t <sub>f</sub>		Fall time	V <sub>GE</sub> = ±15V	—	0.15		0.3
t <sub>off</sub>		Turn-off time	R <sub>G</sub> = 2Ω (Note 1)	—	0.77		—
V <sub>F</sub>	Forward voltage	I <sub>F</sub> = 800A, V <sub>GE</sub> = 0	—	2.3	3.0	V	
t <sub>rr</sub>	Reverse recovery time	I <sub>F</sub> = 800A, V <sub>GE</sub> = -15V, di/dt = 1500A/μs (Note 1)	—	0.08	0.15	μs	
I <sub>SES</sub>	Sense	Sense leakage current	V <sub>SEN</sub> - E = 40V, V <sub>CE</sub> = 0, V <sub>GE</sub> = 0	—	—	200	nA
I <sub>C(SEN-START)</sub>		Sense start current	V <sub>GE</sub> = 15V, V <sub>SE</sub> = 14.8V (Note 2)	1300	—	—	A
V <sub>SEN</sub>		Sense voltage	V <sub>GE</sub> = 15V, I <sub>C</sub> = 3000A (Note 2)	—	—	10	V
R <sub>th(j-c)</sub>	Thermal resistance		Transistor stage	—	—	0.05	°C/W
			Diode stage	—	—	0.1	

# MG800J1US52A

HIGH POWER SWITCHING APPLICATIONS  
MOTOR CONTROL APPLICATIONS

## Note 1: Switching time and reverse recovery time test circuit and timing chart

Switching time test circuit

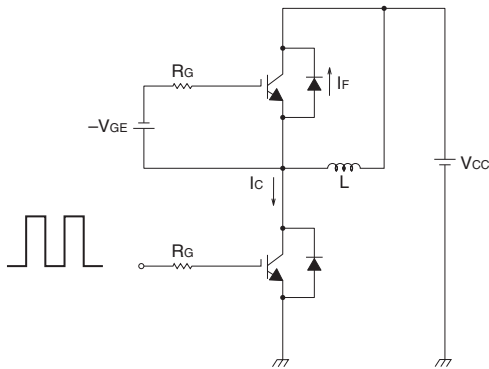

Timing chart

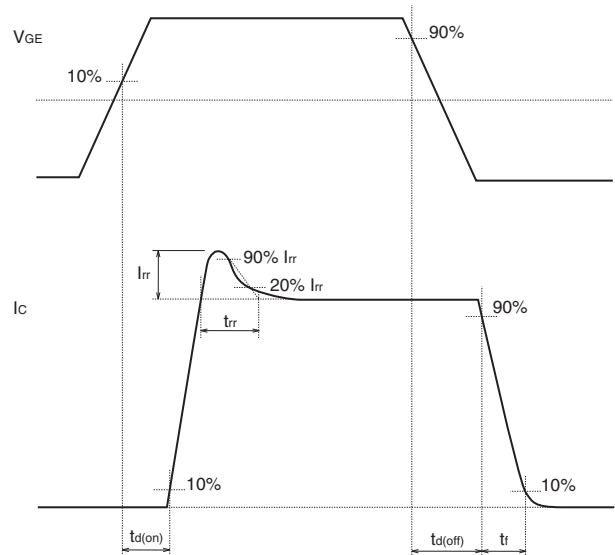

## Note 2: Sense start current and sense voltage test circuit

Test circuit

\*Measurement in the complete charge period.

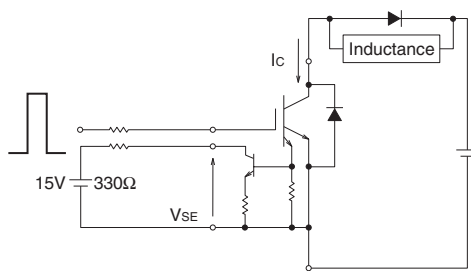

Timing chart

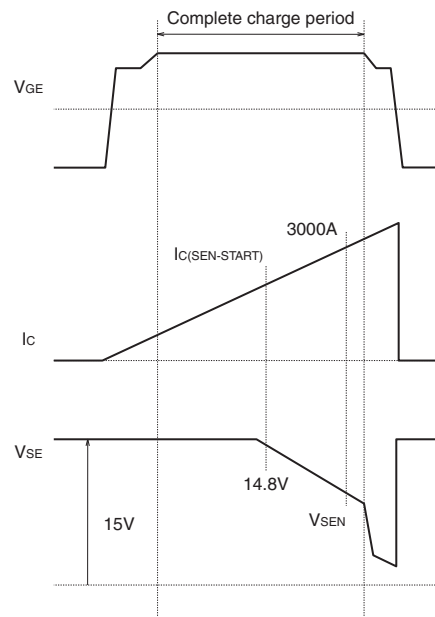

**MG800J1US52A**

HIGH POWER SWITCHING APPLICATIONS  
MOTOR CONTROL APPLICATIONS

<VCE(sat) Rank>

VCE(sat)

Rank symbol	MIN.	MAX.
18	1.5	1.8
19	1.6	1.9
20	1.7	2.0
21	1.8	2.1
22	1.9	2.2
23	2.0	2.3
24	2.1	2.4
25	2.2	2.5
26	2.3	2.6
27	2.4	2.7

<VF Rank>

VF

Rank symbol	MIN.	MAX.
B	1.5	1.8
C	1.7	2.0
D	1.9	2.2
E	2.1	2.4
F	2.3	2.6
G	2.5	2.8
H	2.7	3.0

<Mark position>

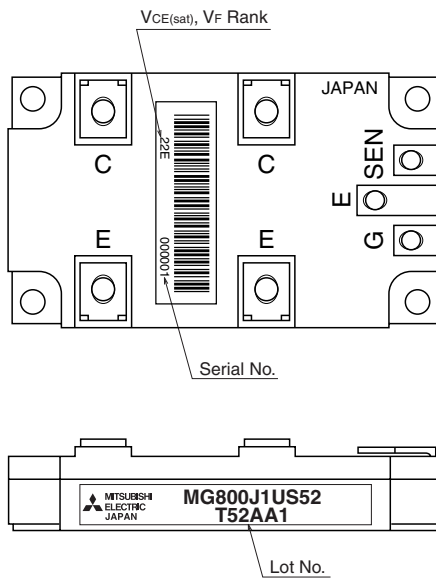

**MG800J1US52A**

HIGH POWER SWITCHING APPLICATIONS  
MOTOR CONTROL APPLICATIONS

PERFORMANCE CURVES

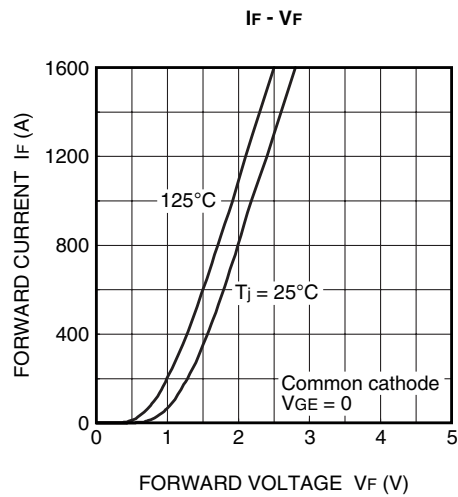
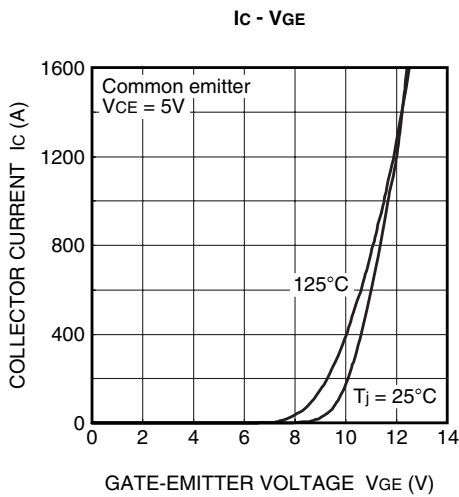
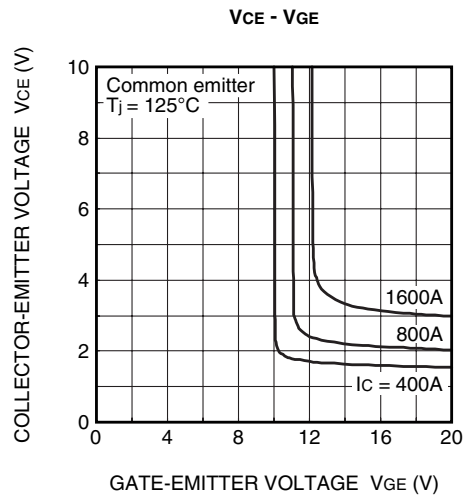
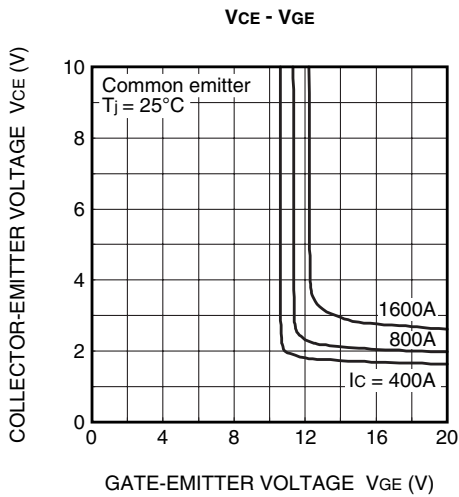
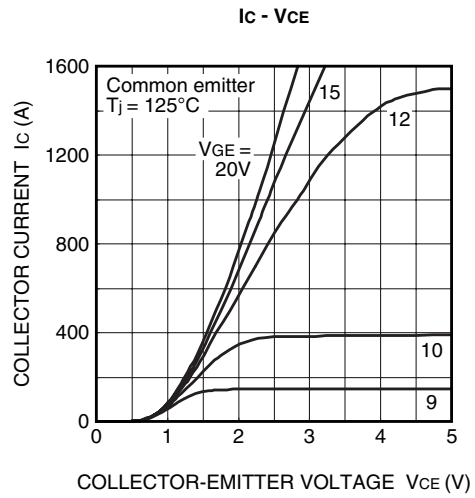
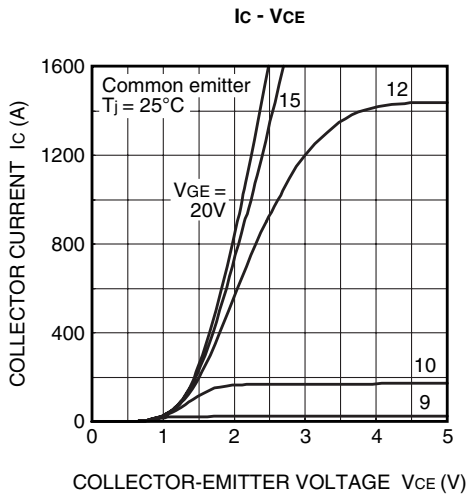

**MG800J1US52A**

HIGH POWER SWITCHING APPLICATIONS  
MOTOR CONTROL APPLICATIONS

SW time - R<sub>G</sub>

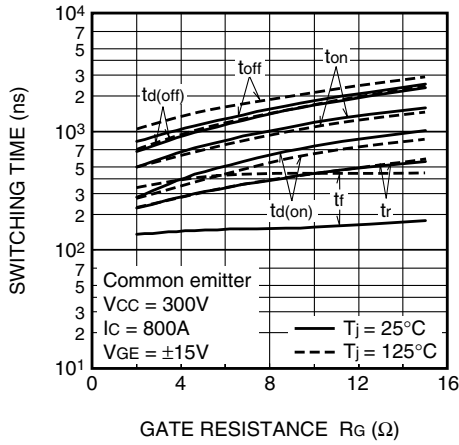

SW time - I<sub>C</sub>

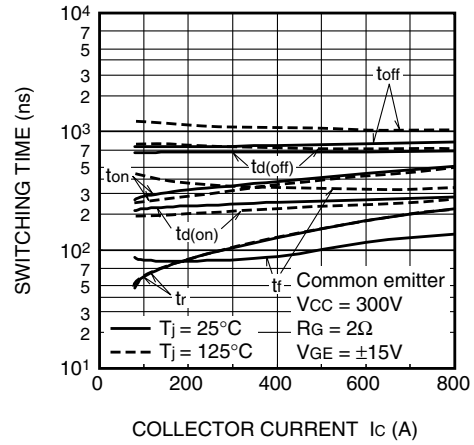

SW loss - R<sub>G</sub>

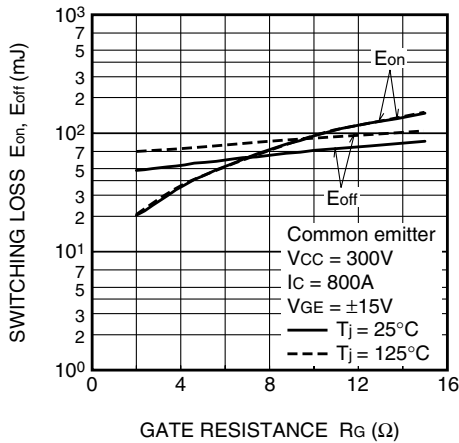

SW loss - I<sub>C</sub>

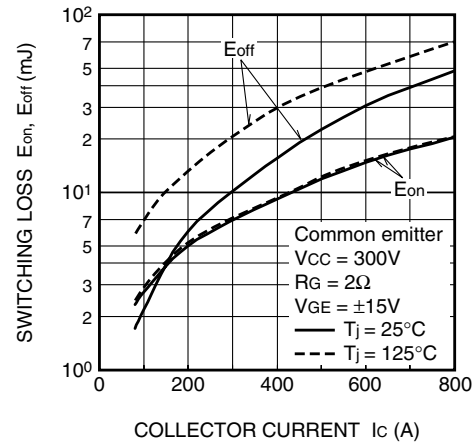

I<sub>rr</sub>, t<sub>rr</sub> - R<sub>G</sub>

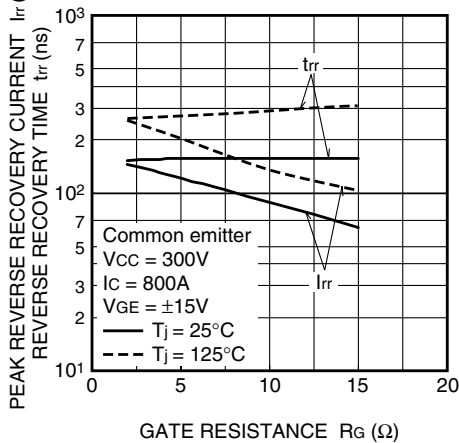

I<sub>rr</sub>, t<sub>rr</sub> - I<sub>F</sub>

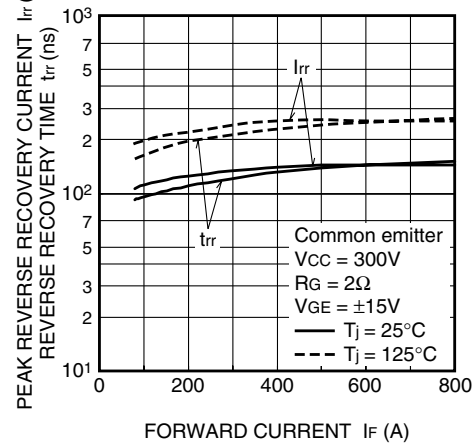

**MG800J1US52A**

HIGH POWER SWITCHING APPLICATIONS  
MOTOR CONTROL APPLICATIONS

