

MHF15-21NG1HSM

MHF15

LEVEL SENSORS

SICK
Sensor Intelligence.

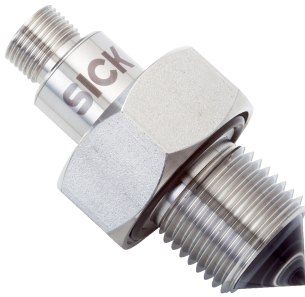

Ordering information

Type	Part no.
MHF15-21NG1HSM	1052273

Other models and accessories → www.sick.com/MHF15



Detailed technical data

Features

Medium	Fluids
Measurement	Switch
Light source	LED
Type of light	Visible red light
Wave length	650 nm
Process pressure	-0.5 bar ... 16 bar
Process temperature	-25 °C ... +55 °C
GOST approval	✓
UL approval	✓
RoHS certificate	✓

Performance

Response time	2 ms
----------------------	------

Electronics

Supply voltage	10 V DC ... 30 V DC ¹⁾
Residual ripple	≤ 5 V _{pp} ²⁾
Power consumption	≤ 30 mA at 24 V DC without output load
Protection class	III
Electrical connection	M12 round connector x 1, 4-pin
Output signal	1 x PNP ³⁾
Switching mode	NO
Signal voltage HIGH	V _s - 2.9 V
Signal voltage LOW	Approx. 0 V
Output current	≤ 100 mA ³⁾ ≤ 100 mA

¹⁾ U_V connections, reverse polarity protected.

²⁾ May not exceed or fall below U_V tolerances.

³⁾ Output overcurrent and short-circuit protected.

⁴⁾ With light/dark ratio 1:1.

Switching frequency	250 Hz ⁴⁾
Enclosure rating	IP 67: EN 60529, IP 69K: EN 40050

- 1) U_V connections, reverse polarity protected.
- 2) May not exceed or fall below U_V tolerances.
- 3) Output overcurrent and short-circuit protected.
- 4) With light/dark ratio 1:1.

Mechanics

Wetted parts	Stainless steel 316L, polysulfon, FPM
Process connection	G 1/2
Housing material	Stainless steel 1.4404

Ambient data

Ambient operating temperature	-25 °C ... +55 °C
Ambient storage temperature	-25 °C ... +70 °C

Classifications

ECl@ss 5.0	27200506
ECl@ss 5.1.4	27200506
ECl@ss 6.0	27200506
ECl@ss 6.2	27200506
ECl@ss 7.0	27200506
ECl@ss 8.0	27200506
ECl@ss 8.1	27200506
ECl@ss 9.0	27200506
ETIM 5.0	EC002654
ETIM 6.0	EC002654
UNSPSC 16.0901	41111950

Dimensional drawing (Dimensions in mm (inch))

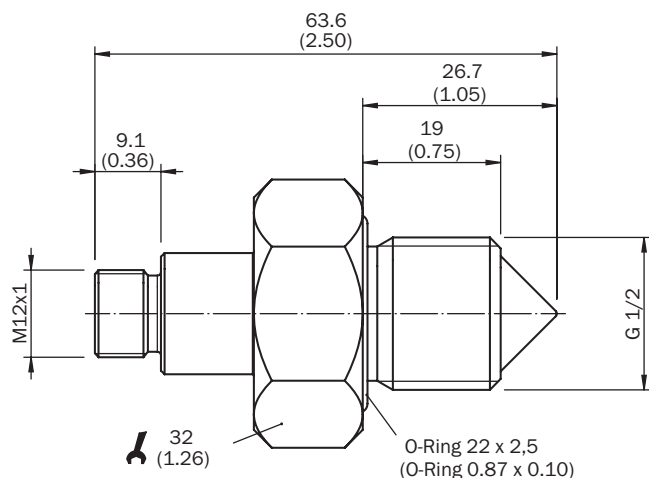

Connection diagram

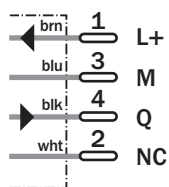











Connection type



Recommended accessories

Other models and accessories → www.sick.com/MHF15

	Brief description	Type	Part no.
Flanges			
	Welded flange G 1/2, Stainless steel V4A (1.4404, 316L)	BEF-FL-316G12-LMH1	4065669
Plug connectors and cables			
	Head A: female connector, M12, 4-pin, straight Head B: cable Cable: PVC, unshielded, 2 m	DOL-1204-G02M	6009382
	Head A: female connector, M12, 4-pin, straight Head B: cable Cable: drag chain use, PUR, halogen-free, unshielded, 2 m	DOL-1204-G02MC	6025900
	Head A: female connector, M12, 4-pin, straight Head B: cable Cable: PVC, unshielded, 5 m	DOL-1204-G05M	6009866
	Head A: female connector, M12, 4-pin, straight Head B: cable Cable: drag chain use, PUR, halogen-free, unshielded, 5 m	DOL-1204-G05MC	6025901
	Head A: female connector, M12, 4-pin, straight Head B: cable Cable: PVC, unshielded, 10 m	DOL-1204-G10M	6010543
	Head A: female connector, M12, 4-pin, straight Head B: cable Cable: drag chain use, PUR, halogen-free, unshielded, 10 m	DOL-1204-G10MC	6025902
	Head A: female connector, M12, 4-pin, angled Head B: cable Cable: PVC, unshielded, 2 m	DOL-1204-W02M	6009383

	Brief description	Type	Part no.
	Head A: female connector, M12, 4-pin, angled Head B: cable Cable: drag chain use, PUR, halogen-free, unshielded, 2 m	DOL-1204-W02MC	6025903
	Head A: female connector, M12, 4-pin, angled Head B: cable Cable: PVC, unshielded, 5 m	DOL-1204-W05M	6009867
	Head A: female connector, M12, 4-pin, angled Head B: cable Cable: drag chain use, PUR, halogen-free, unshielded, 5 m	DOL-1204-W05MC	6025904
	Head A: female connector, M12, 4-pin, angled Head B: cable Cable: PVC, unshielded, 10 m	DOL-1204-W10M	6010541
	Head A: female connector, M12, 4-pin, angled Head B: cable Cable: drag chain use, PUR, halogen-free, unshielded, 10 m	DOL-1204-W10MC	6025905
	Head A: female connector, M12, 4-pin, angled Head B: cable Cable: PVC, unshielded, 15 m	DOL-1204-W15M	6036474
	Head A: female connector, M12, 4-pin, angled Head B: cable Cable: PVC, unshielded, 20 m	DOL-1204-W20M	6033559

SICK AT A GLANCE

SICK is one of the leading manufacturers of intelligent sensors and sensor solutions for industrial applications. A unique range of products and services creates the perfect basis for controlling processes securely and efficiently, protecting individuals from accidents and preventing damage to the environment.

We have extensive experience in a wide range of industries and understand their processes and requirements. With intelligent sensors, we can deliver exactly what our customers need. In application centers in Europe, Asia and North America, system solutions are tested and optimized in accordance with customer specifications. All this makes us a reliable supplier and development partner.

Comprehensive services complete our offering: SICK LifeTime Services provide support throughout the machine life cycle and ensure safety and productivity.

For us, that is “Sensor Intelligence.”

WORLDWIDE PRESENCE:

Contacts and other locations –www.sick.com