



## MIC29311

### 3A Fast-Response LDO Regulator for USB

#### General Description

The MIC29311 is a 3A, fast response, low-dropout (LDO) voltage regulator. Using Micrel's proprietary Super  $\beta$  PNP™ process, the MIC29311 offers exceptional dropout (600mV at 3A) and low ground current (60mA at 3A). Fast transient response allows it to recover quickly from large load changes while maintaining a steady output. The device can be sent into a “zero-current” off mode when the TTL compatible enable is brought low.

Designed specifically for Universal Serial Bus (USB) applications, the MIC29311 works with USB power switches to provide an economical solution for self-powered hubs. The 5.1V output voltage is optimized to work with lower-cost high on-resistance USB power switches (300m $\Omega$ ) to provide a minimum of 4.75V at 500mA to downstream ports. Used with MIC2527 quad USB power switches, the MIC29311 can power up to 6 downstream ports.

Features of the MIC29311 include thermal shutdown, current limit, reversed-battery and reversed-lead insertion protection. An overvoltage clamp is available to maintain a safe output when the input voltage exceeds 8V. An error flag is also available to indicate of the output falls out of regulation, or when an overcurrent condition occurs.

The MIC29311 is available in a 5-pin TO-220 or TO-263 package with a fixed 5.1V output voltage.

For other high current, low-dropout voltage regulators, please see the MIC29150/300/500/750 and the MIC29310, MIC29510, MIC29710.

Data sheets and support documentation can be found on Micrel's web site at: [www.micrel.com](http://www.micrel.com).

#### Features

- Fast transient response
- 3A output current over full temperature range
- 600mV dropout voltage at full load
- Low ground current
- 3% total accuracy
- “Zero” off-mode current
- Thermal Shutdown
- Current Limiting
- Reversed battery protection
- Fixed 5.1V Output

#### Applications

- Self-powered USB hubs
- USB power switching
- High-efficiency linear power supplies
- High-efficiency switching supply post-regulator

#### Ordering Information

Part Number		Voltage	Temperature Range	Package
Standard	RoHS Compliant*			
MIC29311-5.1BT	MIC29311-5.1WT	5.1V	0° to +125°C	TO-220-5

\* RoHs compliant with 'high-melting solder' exemption.

Super  $\beta$  PNP is a trademarks of Micrel, Inc.

Micrel Inc. • 2180 Fortune Drive • San Jose, CA 95131 • USA • tel +1 (408) 944-0800 • fax + 1 (408) 474-1000 • <http://www.micrel.com>

September 2007

M9999-090507

## Typical Application

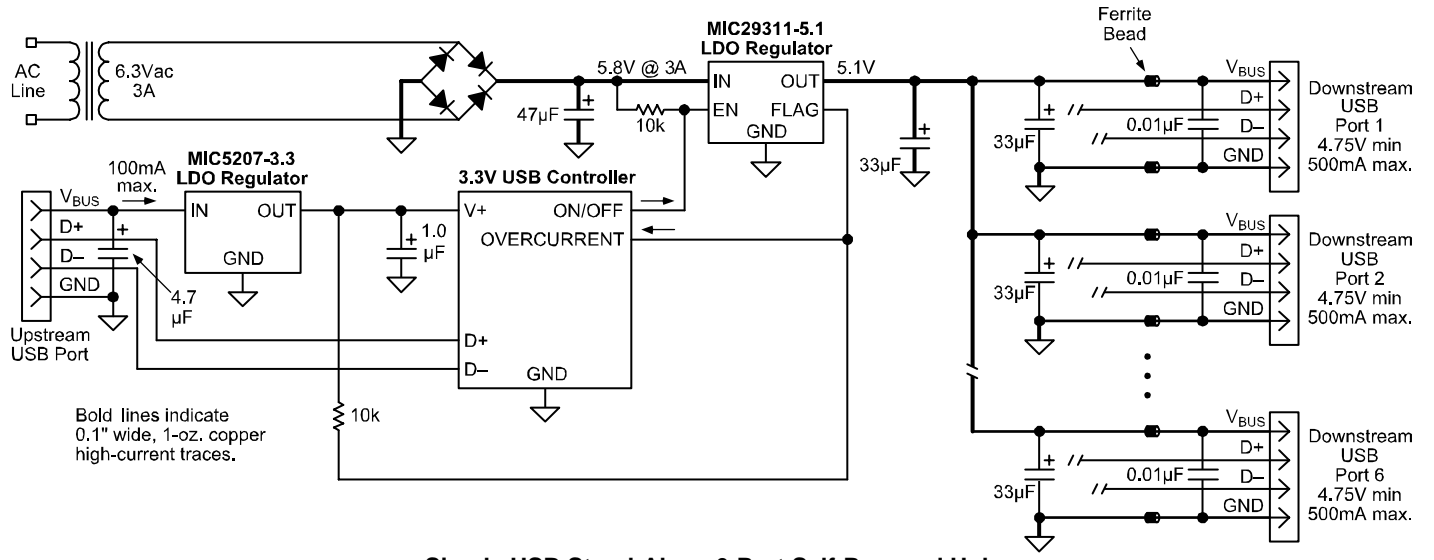

Simple USB Stand-Alone 6-Port Self-Powered Hub

## Pin Configuration

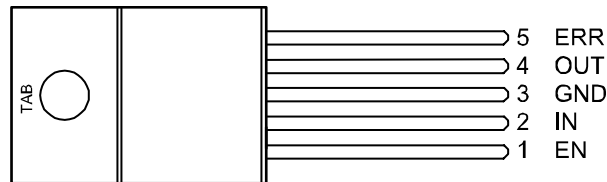

TO-220-5 (T)

## Pin Description

Pin Number	Pin Name	Pin Function
1	EN	Enable (Input): Logic-level high enable/logic-level low shutdown control.
2	IN	Unregulated Input: +16V maximum supply.
3, TAB	GND	Ground: Ground pin and TAB are internally connected.
4	OUT	Regulator Output
5	ERR	Error Flag (Output): Open-collector (active-low) output. Active low indicates overcurrent or undervoltage output conditions.

**Absolute Maximum Ratings<sup>(1)</sup>**

Input Voltage ( $V_{IN}$ )	-20V to +12V
Enable Voltage ( $V_{EN}$ )	-20V to +12V
Error Output Voltage ( $V_{ERR}$ )	0V to +12V
Lead Temperature (soldering, 5 sec.)	260°C
EDS Rating <sup>(3)</sup>	

**Operating Ratings<sup>(2)</sup>**

Input voltage ( $V_{IN}$ )	+8V
Maximum Power Dissipation ( $P_{D(max)}$ ) <sup>(4)</sup>	
Junction Temperature ( $T_J$ )	0°C to +125°C
Package Thermal Resistance	
TO-220-5 ( $\theta_{JA}$ )	55°C/W
TO-220-5 ( $\theta_{JC}$ )	2°C/W

**Electrical Characteristics**

$T_A = 25^\circ\text{C}$ , **bold** values indicate  $0^\circ\text{C} \leq T_J \leq +125^\circ\text{C}$ , unless noted.

Parameter	Condition	Min	Typ	Max	Units
Output Tolerance	$10\text{mA} \leq I_{OUT} < 3\text{A}$ , $(V_{OUT} + 1\text{V}) \leq V_{IN} \leq 8\text{V}$	<b>-3</b>		<b>+3</b>	%
Line Regulation	$I_{OUT} = 10\text{mA}$ , $(V_{OUT} + 1\text{V}) \leq V_{IN} \leq 8\text{V}$		0.06	0.5	%
Load Regulation	$V_{IN} = V_{OUT} + 1\text{V}$ , $10\text{mA} \leq I_{OUT} \leq 3\text{A}$		0.2	1	%
Output Voltage Temperature Coefficient	<b>Note 5</b>		<b>20</b>	<b>100</b>	ppm/°C
Dropout Voltage, <b>Note 6</b>	$I_{OUT} = 100\text{mA}$		80	<b>200</b>	mV
	$I_{OUT} = 750\text{mA}$		220		mV
	$I_{OUT} = 1.5\text{A}$		330		mV
	$I_{OUT} = 3\text{A}$		600	<b>1000</b>	mV
Ground Current, <b>Note 7</b>	$V_{IN} = 6.1\text{V}$ , $I_{OUT} = 750\text{mA}$		5	<b>20</b>	mA
	$V_{IN} = 6.1\text{V}$ , $I_{OUT} = 1.5\text{A}$		15		mA
	$V_{IN} = 6.1\text{V}$ , $I_{OUT} = 3\text{A}$		60	<b>150</b>	mA
Dropout Ground Current	$V_{IN} = 6.1\text{V}$ , $I_{OUT} = 10\text{mA}$		2	3	mA
Current Limit	$V_{IN} = 3\text{V}$ , $V_{OUT} = 0\text{V}$	<b>3.0</b>	3.8		A
Minimum Load Current			7	10	mA
Output Noise Voltage	$C_{LOAD} = 10\mu\text{F}$		400		$\mu\text{V(rms)}$
	$C_{LOAD} = 33\mu\text{F}$		260		$\mu\text{V(rms)}$
<b>Error Flag Output</b>					
Output Leakage Current	$V_{IN} = 6.1\text{V}$ , $V_{ERR} = 8\text{V}$		0.1	<b>1</b> <b>2</b>	$\mu\text{A}$ $\mu\text{A}$
Output Low Voltage	$V_{IN} = 4.1\text{V}$ , $I_{ERR} = 250\mu\text{A}$		220	<b>300</b> <b>400</b>	mV mV

Parameter	Condition	Min	Typ	Max	Units
<b>Enable Input</b>					
Logic Low Voltage	Regulator shutdown			<b>0.8</b>	V
Logic High Voltage	Regulator enable	<b>2.4</b>			
Enable Input Current	$V_{EN} = V_{IN}$		15	30 <b>75</b>	$\mu A$ $\mu A$
	$V_{EN} = 0.8V$			2 <b>4</b>	$\mu A$ $\mu A$
Regulator Output Current	$V_{IN} = \leq 8V$ , $V_{EN} \leq 0.8V$ (shutdown), $V_{OUT} = 0$ , <b>Note 8</b>		10	<b>20</b>	$\mu A$

**Notes:**

- Exceeding the absolute maximum rating may damage the device.
- The device is not guaranteed to function outside its operating rating.
- Devices are ESD sensitive. Handling precautions recommended.
- $P_{D(max)} = T_{J(max)} - T_A) / \theta_{JA}$ , where  $\theta_{JA}$  depends upon the pointed circuit board layout. See "Applications Information."
- Output voltage temperature coefficient is defined as the  $\Delta V_{OUT(worst\ case)} / (T_{J(max)} - T_{J(min)})$  where  $T_{J(max)}$  is  $+125^\circ C$  and  $T_{J(min)}$  is  $0^\circ C$ .
- $V_{DO} = V_{IN} - V_{OUT}$  when  $V_{OUT}$  decreases to 99% of its nominal output voltage with  $V_{IN} = V_{OUT} + 1V$ .
- $I_{GND}$  is the quiescent current.  $I_{IN} = I_{GND} + I_{OUT}$ .
- $V_{EN} \leq 0.8V$  and  $V_{IN} \leq 8V$ ,  $V_{OUT} = 0$ .

# Typical Characteristics

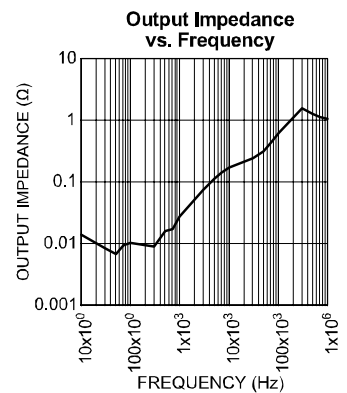
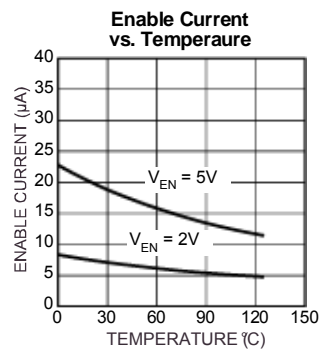
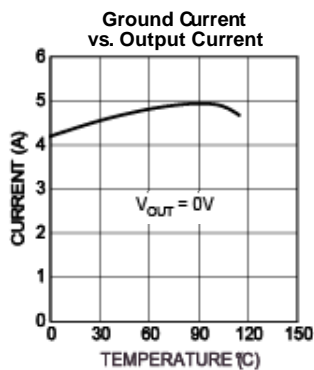
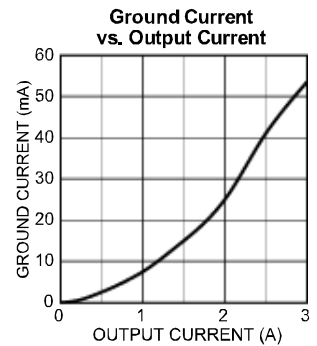
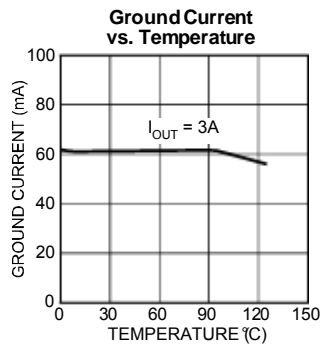
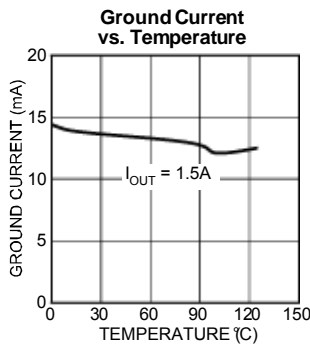
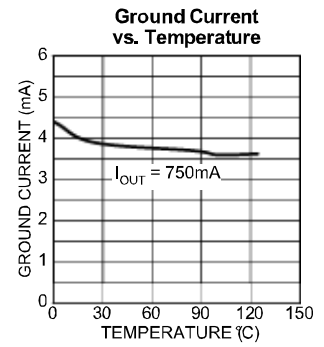
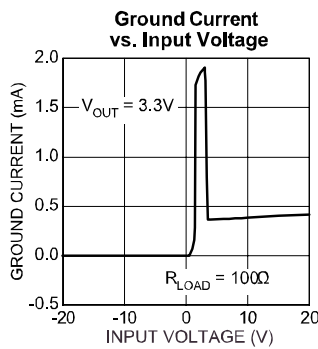
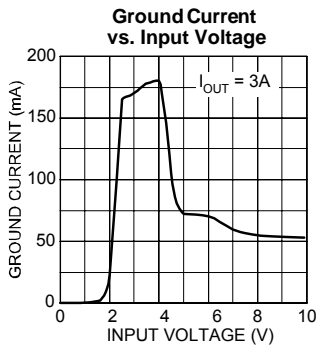
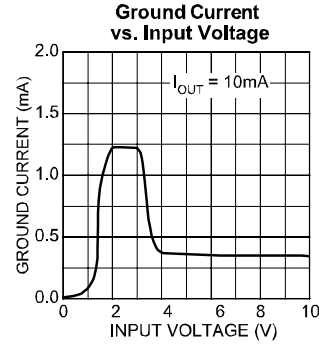
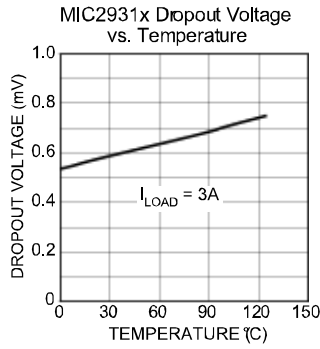
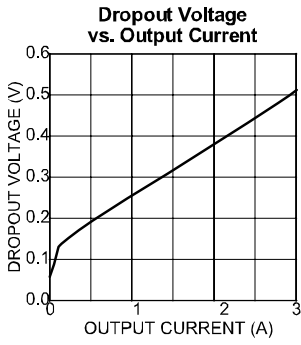

# Functional Characteristics

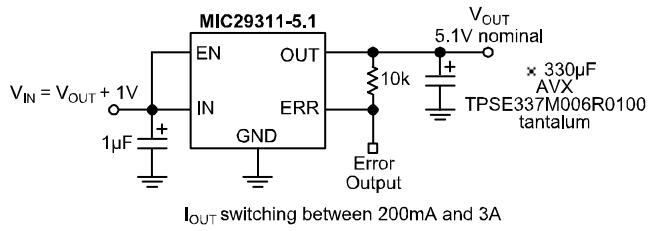

**Load Transient Response Test Circuit**

**Load Transient Response (See Test Circuit Schematic)**

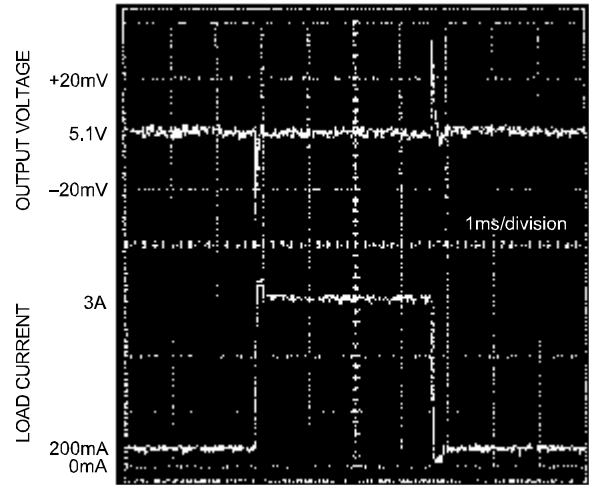

**Line Transient Response with 3A Load, 10µF Output Capacitance**

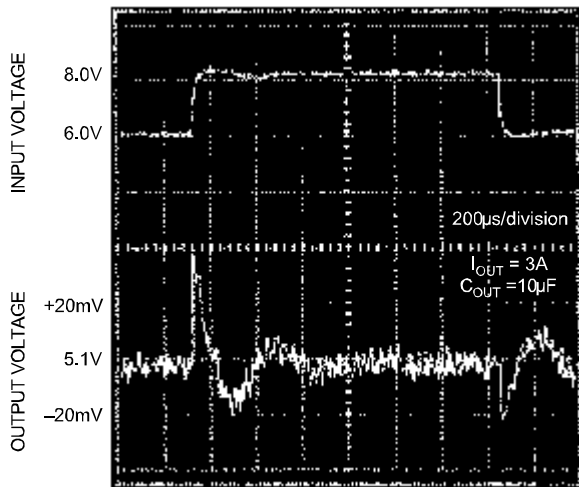

**Line Transient Response with 3A Load, 100µF Output Capacitance**

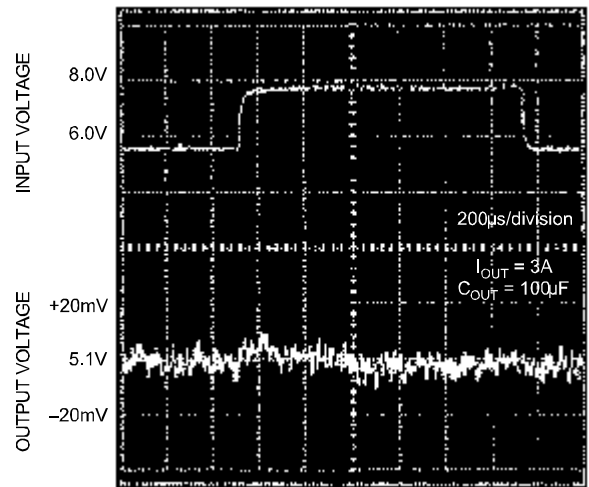

### Functional Diagram

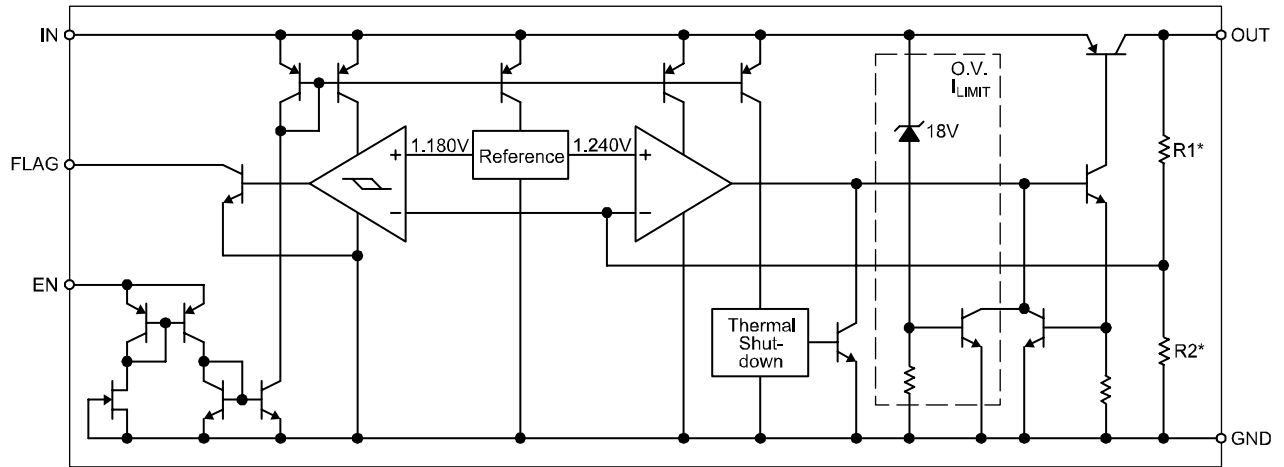

## Application Information

The MIC29311 is a high-performance low-dropout voltage regulator suitable for all moderate to high-current voltage regulator applications. The 600mV dropout voltage at full load makes it especially valuable in battery-powered systems and as high-efficiency noise filters in “post-regulator” applications. Its unique output voltage makes the MIC29311 ideal for Universal Serial Bus (USB) power switching applications. Unlike older NPN-pass transistor designs, where the minimum dropout voltage is limited by the base-emitter voltage drop and collector-emitter saturation voltage, dropout performance of the PNP output of these devices is limited merely by the low VCE saturation voltage.

A trade-off for the low dropout voltage is a varying base drive requirement. But Micrel’s Super  $\beta$  PNP™ process reduces this drive requirement to merely 1% to 5% of the load current.

The MIC29311 regulator is fully protected from damage due to fault conditions. Current limiting is provided. This limiting is linear; output current under overload conditions is constant. Thermal shutdown disables the device when the die temperature exceeds the maximum safe operating temperature. Transient protection allows device (and load) survival even when the input voltage spikes above and below nominal. The output structure of these regulators allows voltages in excess of the desired output voltage to be applied without reverse current flow. The MIC29311 version offers a logic level on-off control: when disabled, the device draws nearly zero current.

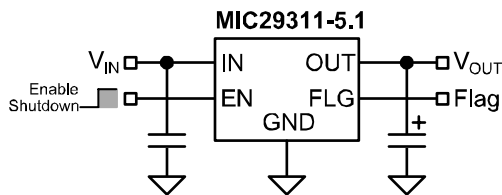

Figure 1. Input and Output Capacitors

### Thermal Design

Linear regulators are simple to use. The most complicated design parameters to consider are thermal characteristics. Thermal design requires the following application-specific parameters:

- Maximum ambient temperature,  $T_A$
- Output Current,  $I_{OUT}$
- Output Voltage,  $V_{OUT}$
- Input Voltage,  $V_{IN}$

First, calculate the power dissipation of the regulator from these numbers and the device parameters from this datasheet.

$$P_D = I_{OUT}(1.02V_{IN} - V_{OUT})$$

Where the ground current is approximated by 2% of  $I_{OUT}$ . Then the heat sink thermal resistance is determined by:

$$\theta_{SA} = \frac{T_{J(max)} - T_A}{P_D} - \theta_{JC} + \theta_{CS}$$

Where  $T_{J(max)} \leq 125^\circ\text{C}$  and  $\theta_{CS}$  is between 0 and  $2^\circ\text{C/W}$ .

The heat sink may be significantly reduced in applications where the minimum input voltage is known and is large compared with the dropout voltage. Use a series input resistor to drop excessive voltage and distribute the heat between this resistor and the regulator. The low dropout properties of Micrel Super  $\beta$  PNP regulators allow very significant reductions in regulator power dissipation and the associated heat sink without compromising performance. When this technique is employed, a capacitor of at least  $1\mu\text{F}$  is needed directly between the input and regulator ground.

Please refer to Application Note 9 for further details and examples on thermal design and heat sink specification.

### Capacitor Requirements

For stability and minimum output noise, a capacitor on the regulator output is necessary. The value of this capacitor is dependent upon the output current; lower currents allow smaller capacitors. The MIC29311 regulator is stable with a minimum capacitor value of  $10\mu\text{F}$  at full load.

This capacitor need not be an expensive low ESR type: aluminum electrolytics are adequate. In fact, extremely low ESR capacitors may contribute to instability. Tantalum capacitors are recommended for systems where fast load transient response is important.

Where the regulator is powered from a source with high AC impedance, a  $0.1\mu\text{F}$  capacitor connected between Input and GND is recommended. This capacitor should have good characteristics to above 250kHz. When the regulator is located more than 3 inches from the ac bulk supply capacitors, a  $1\mu\text{F}$  or greater input capacitor is recommended.

### Minimum Load Current

The MIC29311 regulator is specified between finite loads. If the output current is too small, leakage currents dominate and the output voltage rises. A 10mA minimum load current is necessary for proper regulation.



### Enable Input

The MIC29311 version features an enable (EN) input that allows on-off control of the device. Special design allows “zero” current drain when the device is disabled—only micro-amperes of leakage current flows. The EN input has TTL/CMOS compatible thresholds for simple interfacing with logic, or may be directly tied to  $V_{IN}$ . Enabling the regulator requires approximately 20 $\mu$ A of current into the EN pin.

### Error Flag

The MIC29311 features an error flag which looks at the output voltage and signals an error condition when this voltage drops 5% below its expected value. The error flag is an open-collector output that pulls low under fault conditions. It may sink 10mA. Low output voltage signifies a number of possible problems, including an overcurrent fault (the device is in current limit) and low input voltage. The flag output is inoperative during overtemperature shutdown conditions.

### USB Applications

The main application of the MIC29311 is to control power distribution in a self-powered Universal Serial Bus hub. For self-powered hubs, the MIC29311 provides 5.1V  $\pm$ 3% to downstream ports from an unregulated supply voltage (see “Typical Application”). USB requires that the downstream voltage supplied to peripherals from a self-powered hub is between 4.75V and 5.25V. The MIC29311 provides regulation with this requirement. The enable pin input controls ganged power for up to seven downstream ports, each drawing up to 500mA. The device has an output current limiting circuit that linearly decreases the output voltage as the output current exceeds 3A. When the part is out of regulation by 5%, the error flag goes low and signals a fault condition to the microcontroller, allowing the system to be disabled. This provides the overcurrent protection that is required by USB.

In Figure 2, the MIC29311 provides power to the MIC2527 quad power switches. The MIC2527 provides power switching to four independently controlled downstream ports. Two MIC2527's can be used to provide a 6-port, self-powered hub in conjunction with the MIC29311. The 5.1V output of the MIC29311 is optimized to ensure that under maximum load condition, the output voltage of each channel of the MIC2527 remains above 4.75V. This is the minimum voltage requirement for self-powered USB hubs. The output voltage is a function of the minimum output voltage of the power supply, the PCB trace resistance and the on-resistance of the switch. Table 1 shows the maximum allowable on-resistance for a 5.1V power supply in a self-powered hub, assuming 30mV of voltage drop due to PCB trace resistance. The 5.1V of the MIC29311 and the 300m $\Omega$  on-resistance of each MIC2527 switch provide an economical solution to power management of self-powered hubs.

Nominal Voltage	Supply Tolerance	Minimum Voltage	Maximum Voltage	Maximum $R_{ON}$
5.10V	1%	5.05V	5.15V	540m $\Omega$
	2%	5V	5.2V	440 m $\Omega$
	<b>3%</b>	<b>4.95V</b>	<b>5.25V</b>	340 m $\Omega$
	4%	4.9V	5.3V	–
	5%	4.85V	5.38V	–

**Table 1. Max. Allowable On-Resistance**

For further information concerning USB power management, refer to Application Note 17 and Application Hint 30.



**Package Information**

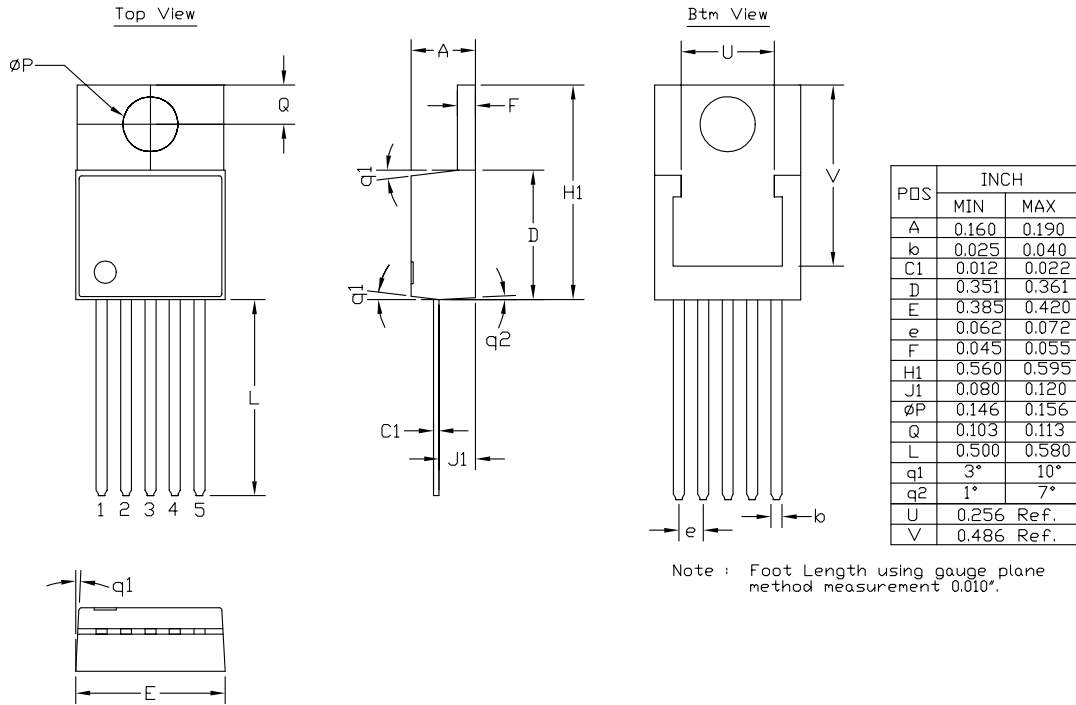

**5-Pin TO-220 (T)**

**MICREL, INC. 2180 FORTUNE DRIVE SAN JOSE, CA 95131 USA**  
 TEL +1 (408) 944-0800 FAX +1 (408) 474-1000 WEB <http://www.micrel.com>

The information furnished by Micrel in this data sheet is believed to be accurate and reliable. However, no responsibility is assumed by Micrel for its use. Micrel reserves the right to change circuitry and specifications at any time without notification to the customer.

Micrel Products are not designed or authorized for use as components in life support appliances, devices or systems where malfunction of a product can reasonably be expected to result in personal injury. Life support devices or systems are devices or systems that (a) are intended for surgical implant into the body or (b) support or sustain life, and whose failure to perform can be reasonably expected to result in a significant injury to the user. A Purchaser's use or sale of Micrel Products for use in life support appliances, devices or systems is a Purchaser's own risk and Purchaser agrees to fully indemnify Micrel for any damages resulting from such use or sale.

© 1998 Micrel, Incorporated.