

MJ11028, MJ11030, MJ11032 (NPN) MJ11029, MJ11033 (PNP)



ON Semiconductor®

<http://onsemi.com>

High-Current Complementary Silicon Power Transistors

High-Current Complementary Silicon Power Transistors are for use as output devices in complementary general purpose amplifier applications.

Features

- High DC Current Gain – $h_{FE} = 1000$ (Min) @ $I_C = 25$ Adc
 $h_{FE} = 400$ (Min) @ $I_C = 50$ Adc
- Curves to 100 A (Pulsed)
- Diode Protection to Rated I_C
- Monolithic Construction with Built-In Base-Emitter Shunt Resistor
- Junction Temperature to +200°C
- Pb-Free Packages are Available*

MAXIMUM RATINGS ($T_J = 25^\circ\text{C}$ unless otherwise noted)

Rating	Symbol	Value	Unit
Collector-Emitter Voltage MJ11028/29 MJ11030 MJ11032/33	V_{CEO}	60 90 120	Vdc
Collector-Base Voltage MJ11028/29 MJ11030 MJ11032/33	V_{CBO}	60 90 120	Vdc
Emitter-Base Voltage	V_{EBO}	5.0	Vdc
Collector Current – Continuous – Peak (Note 1)	I_C	50 100	Adc
Base Current – Continuous	I_B	2.0	Adc
Total Power Dissipation @ $T_C = 25^\circ\text{C}$ Derate Above 25°C @ $T_C = 100^\circ\text{C}$	P_D	300 1.71	W W/°C
Operating and Storage Junction Temperature Range	T_J, T_{stg}	-55 to +200	°C

THERMAL CHARACTERISTICS

Characteristic	Symbol	Max	Unit
Maximum Lead Temperature for Soldering Purposes for ≤ 10 seconds	T_L	275	°C
Thermal Resistance, Junction-to-Case	$R_{\theta JC}$	0.58	°C/W

Maximum ratings are those values beyond which device damage can occur. Maximum ratings applied to the device are individual stress limit values (not normal operating conditions) and are not valid simultaneously. If these limits are exceeded, device functional operation is not implied, damage may occur and reliability may be affected.

1. Pulse Test: Pulse Width = 5 μs , Duty Cycle $\leq 10\%$.

*For additional information on our Pb-Free strategy and soldering details, please download the ON Semiconductor Soldering and Mounting Techniques Reference Manual, SOLDERRM/D.

**50 AMPERE
COMPLEMENTARY
DARLINGTON POWER
TRANSISTORS
60 – 120 VOLTS
300 WATTS**

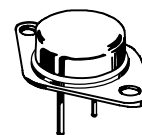

TO-204 (TO-3)
CASE 197A
STYLE 1

MARKING DIAGRAM



MJ110xx = Device Code
xx = 28, 29, 30, 32, 33
G = Pb-Free Package
A = Location Code
YY = Year
WW = Work Week
MEX = Country of Origin

ORDERING INFORMATION

See detailed ordering and shipping information in the package dimensions section on page 3 of this data sheet.

MJ11028, MJ11030, MJ11032 (NPN)

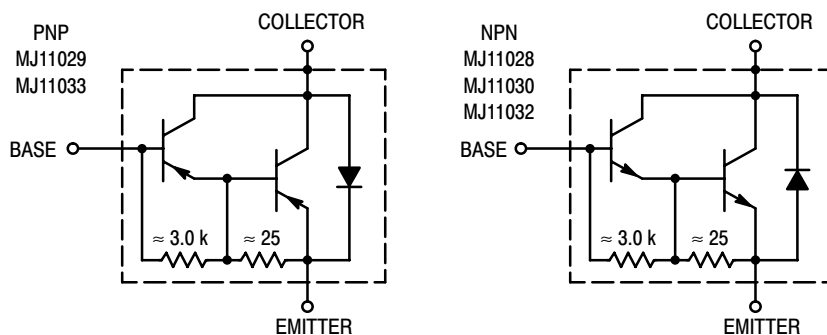

Figure 1. Darlington Circuit Schematic

ELECTRICAL CHARACTERISTICS ($T_C = 25^\circ\text{C}$ unless otherwise noted)

Characteristic	Symbol	Min	Max	Unit
OFF CHARACTERISTICS				
Collector–Emitter Breakdown Voltage (Note 1) ($I_C = 1.00\text{ mAdc}$, $I_B = 0$)	MJ11028, MJ11029 MJ11030 MJ11032, MJ11033	$V_{(BR)CEO}$	60 90 120	– – – Vdc
Collector–Emitter Leakage Current ($V_{CE} = 60\text{ Vdc}$, $R_{BE} = 1\text{ k}\Omega$) ($V_{CE} = 90\text{ Vdc}$, $R_{BE} = 1\text{ k}\Omega$) ($V_{CE} = 120\text{ Vdc}$, $R_{BE} = 1\text{ k}\Omega$) ($V_{CE} = 60\text{ Vdc}$, $R_{BE} = 1\text{ k}\Omega$, $T_C = 150^\circ\text{C}$) ($V_{CE} = 120\text{ Vdc}$, $R_{BE} = 1\text{ k}\Omega$, $T_C = 150^\circ\text{C}$)	MJ11028, MJ11029 MJ11030 MJ11032, MJ11033 MJ11028, MJ11029 MJ11032, MJ11033	I_{CER}	– – – – –	2 2 2 10 10 mAdc
Emitter Cutoff Current ($V_{BE} = 5\text{ Vdc}$, $I_C = 0$)		I_{EBO}	–	5 mAdc
Collector–Emitter Leakage Current ($V_{CE} = 50\text{ Vdc}$, $I_B = 0$)		I_{CEO}	–	2 mAdc
ON CHARACTERISTICS (Note 1)				
DC Current Gain ($I_C = 25\text{ Adc}$, $V_{CE} = 5\text{ Vdc}$) ($I_C = 50\text{ Adc}$, $V_{CE} = 5\text{ Vdc}$)		h_{FE}	1 k 400	18 k – –
Collector–Emitter Saturation Voltage ($I_C = 25\text{ Adc}$, $I_B = 250\text{ mAdc}$) ($I_C = 50\text{ Adc}$, $I_B = 500\text{ mAdc}$)		$V_{CE(sat)}$	– –	2.5 3.5 Vdc
Base–Emitter Saturation Voltage ($I_C = 25\text{ Adc}$, $I_B = 200\text{ mAdc}$) ($I_C = 50\text{ Adc}$, $I_B = 300\text{ mAdc}$)		$V_{BE(sat)}$	– –	3.0 4.5 Vdc

1. Pulse Test: Pulse Width $\leq 300\ \mu\text{s}$, Duty Cycle $\leq 2.0\%$.

MJ11028, MJ11030, MJ11032 (NPN)

ORDERING INFORMATION

Device	Package	Shipping
MJ11028	TO-204	100 Units / Tray
MJ11028G	TO-204 (Pb-Free)	
MJ11029	TO-204	
MJ11029G	TO-204 (Pb-Free)	
MJ11030	TO-204	
MJ11030G	TO-204 (Pb-Free)	
MJ11032	TO-204	
MJ11032G	TO-204 (Pb-Free)	
MJ11033	TO-204	
MJ11033G	TO-204 (Pb-Free)	

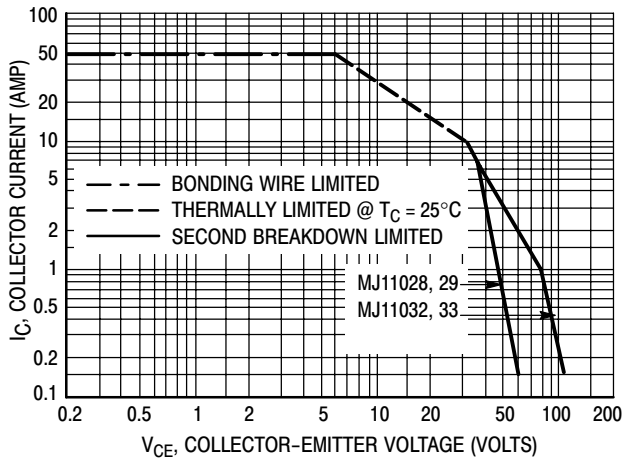

Figure 2. DC Safe Operating Area

There are two limitations on the power-handling ability of a transistor: average junction temperature and second breakdown. Safe operating area curves indicate $I_C - V_{CE}$ limits of the transistor that must be observed for reliable operation, i.e., the transistor must not be subjected to greater dissipation than the curves indicate.

The data of Figure 2 is based on $T_{J(pk)} = 200^\circ\text{C}$; T_C is variable depending on conditions. At high case temperatures, thermal limitations will reduce the power that can be handled to values less than the limitations imposed by second breakdown.

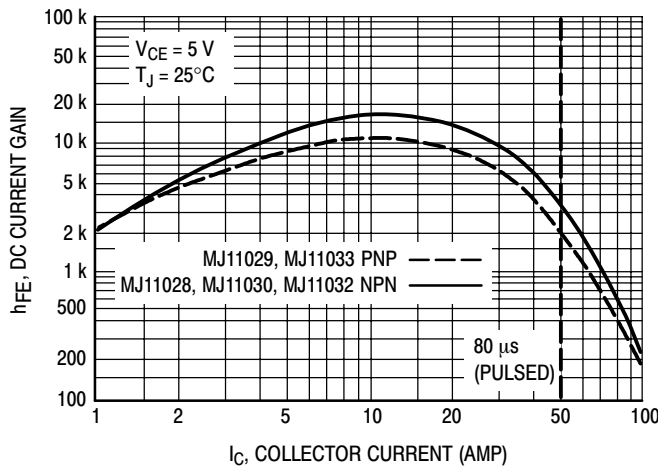

Figure 3. DC Current Gain

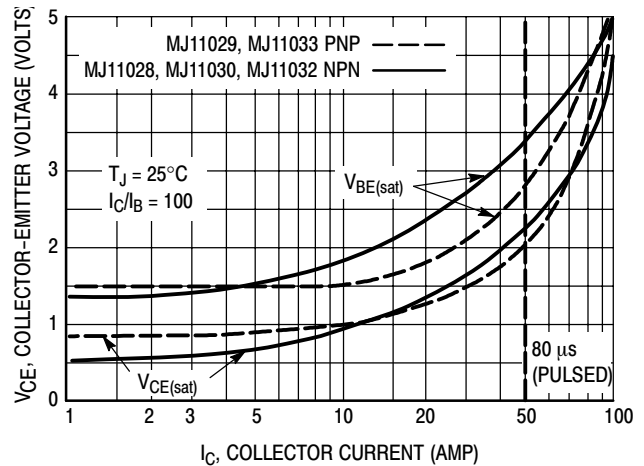
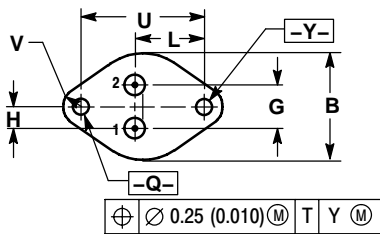
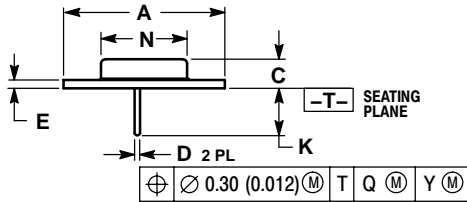

Figure 4. "On" Voltage

MJ11028, MJ11030, MJ11032 (NPN)

PACKAGE DIMENSIONS

TO-204 (TO-3)
CASE 197A-05
ISSUE K



NOTES:

1. DIMENSIONING AND TOLERANCING PER ANSI Y14.5M, 1982.
2. CONTROLLING DIMENSION: INCH.

DIM	INCHES		MILLIMETERS	
	MIN	MAX	MIN	MAX
A	1.530 REF		38.86 REF	
B	0.990	1.050	25.15	26.67
C	0.250	0.335	6.35	8.51
D	0.057	0.063	1.45	1.60
E	0.060	0.070	1.53	1.77
G	0.430 BSC		10.92 BSC	
H	0.215 BSC		5.46 BSC	
K	0.440	0.480	11.18	12.19
L	0.665 BSC		16.89 BSC	
N	0.760	0.830	19.31	21.08
Q	0.151	0.165	3.84	4.19
U	1.187 BSC		30.15 BSC	
V	0.131	0.188	3.33	4.77

STYLE 1:

1. BASE
 2. EMITTER
- CASE: COLLECTOR

ON Semiconductor and are registered trademarks of Semiconductor Components Industries, LLC (SCILLC). SCILLC reserves the right to make changes without further notice to any products herein. SCILLC makes no warranty, representation or guarantee regarding the suitability of its products for any particular purpose, nor does SCILLC assume any liability arising out of the application or use of any product or circuit, and specifically disclaims any and all liability, including without limitation special, consequential or incidental damages. "Typical" parameters which may be provided in SCILLC data sheets and/or specifications can and do vary in different applications and actual performance may vary over time. All operating parameters, including "Typicals" must be validated for each customer application by customer's technical experts. SCILLC does not convey any license under its patent rights nor the rights of others. SCILLC products are not designed, intended, or authorized for use as components in systems intended for surgical implant into the body, or other applications intended to support or sustain life, or for any other application in which the failure of the SCILLC product could create a situation where personal injury or death may occur. Should Buyer purchase or use SCILLC products for any such unintended or unauthorized application, Buyer shall indemnify and hold SCILLC and its officers, employees, subsidiaries, affiliates, and distributors harmless against all claims, costs, damages, and expenses, and reasonable attorney fees arising out of, directly or indirectly, any claim of personal injury or death associated with such unintended or unauthorized use, even if such claim alleges that SCILLC was negligent regarding the design or manufacture of the part. SCILLC is an Equal Opportunity/Affirmative Action Employer. This literature is subject to all applicable copyright laws and is not for resale in any manner.

PUBLICATION ORDERING INFORMATION

LITERATURE FULFILLMENT:
Literature Distribution Center for ON Semiconductor
P.O. Box 61312, Phoenix, Arizona 85082-1312 USA
Phone: 480-829-7710 or 800-344-3860 Toll Free USA/Canada
Fax: 480-829-7709 or 800-344-3867 Toll Free USA/Canada
Email: orderlit@onsemi.com

N. American Technical Support: 800-282-9855 Toll Free
USA/Canada

Japan: ON Semiconductor, Japan Customer Focus Center
2-9-1 Kamimeguro, Meguro-ku, Tokyo, Japan 153-0051
Phone: 81-3-5773-3850

ON Semiconductor Website: <http://onsemi.com>

Order Literature: <http://www.onsemi.com/litorder>

For additional information, please contact your local Sales Representative.