

Features

- Epitaxial Planar Die Construction
- High Collector-Emitter Voltage
- Ideally Suited for Automated Assembly Processes
- Ideal for Power Switching or Amplification Applications
- **Lead Free By Design/RoHS Compliant (Note 1)**
- **"Green" Device (Note 2)**

Mechanical Data

- Case: DPAK
- Case Material: Molded Plastic, "Green" Molding Compound. UL Flammability Classification Rating 94V-0
- Moisture Sensitivity: Level 1 per J-STD-020D
- Terminals: Finish — Matte Tin annealed over Copper Leadframe (Lead Free Plating). Solderable per MIL-STD-202, Method 208
- Marking Information: See Page 3
- Ordering Information: See Page 3
- Weight: 0.34 grams (approximate)

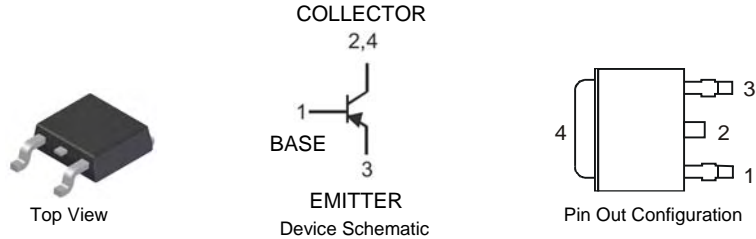

Maximum Ratings @ $T_A = 25^\circ\text{C}$ unless otherwise specified

Characteristic	Symbol	Value	Unit
Collector-Base Voltage	V_{CBO}	-300	V
Collector-Emitter Voltage	V_{CEO}	-300	V
Emitter-Base Voltage	V_{EBO}	-3	V
Continuous Collector Current	I_C	-0.5	A
Peak Pulse Collector Current	I_{CM}	-0.75	A

Thermal Characteristics

Characteristic	Symbol	Value	Unit
Power Dissipation @ $T_C = 25^\circ\text{C}$	P_D	15	W
Thermal Resistance, Junction to Case	$R_{\theta JC}$	8.33	$^\circ\text{C/W}$
Power Dissipation @ $T_A = 25^\circ\text{C}$ (Note 3)	P_D	1.56	W
Thermal Resistance, Junction to Ambient	$R_{\theta JA}$	81	$^\circ\text{C/W}$
Operating and Storage Temperature Range	T_J, T_{STG}	-55 to +150	$^\circ\text{C}$

Electrical Characteristics @ $T_A = 25^\circ\text{C}$ unless otherwise specified

Characteristic	Symbol	Min	Typ	Max	Unit	Test Condition
OFF CHARACTERISTICS						
Collector-Emitter Sustaining Voltage (Note 4)	$V_{(SUS)CEO}$	-300	—	—	V	$I_C = -1\text{mA}, I_B = 0$
Collector Cutoff Current	I_{CBO}	—	—	-100	μA	$V_{CB} = -300\text{V}, I_E = 0$
Emitter Cutoff Current	I_{EBO}	—	—	-100	μA	$V_{EB} = -3\text{V}, I_C = 0$
ON CHARACTERISTICS (Note 4)						
DC Current Gain	h_{FE}	30	—	240	—	$V_{CE} = -10\text{V}, I_C = -50\text{mA}$

- Notes:
1. No purposefully added lead.
 2. Diodes Inc.'s "Green" policy can be found on our website at http://www.diodes.com/products/lead_free/index.php.
 3. Device mounted on FR-4 PCB with the minimum pad size recommended.
 4. Measured under pulsed conditions. Pulse width = 300 μs . Duty cycle $\leq 2\%$.

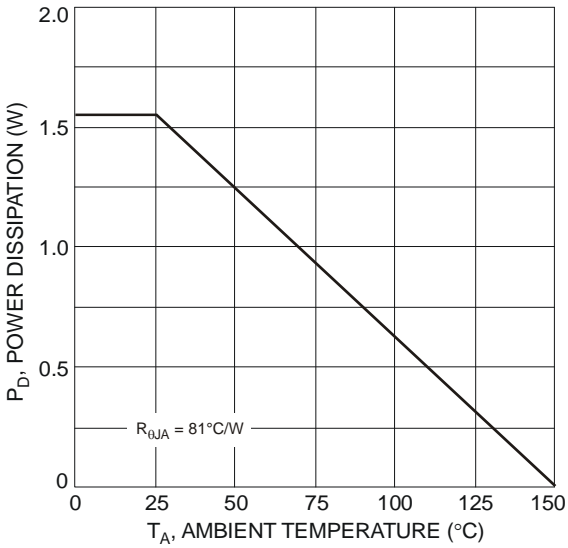

Fig. 1 Power Dissipation vs. Ambient Temperature (Note 3)

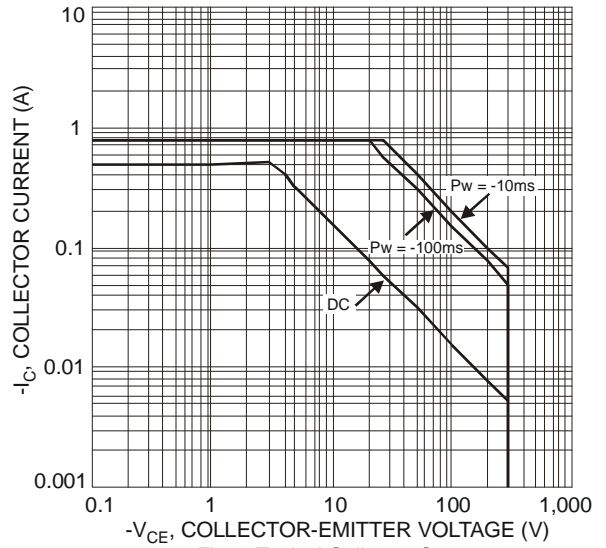

Fig. 2 Typical Collector Current vs. Collector-Emitter Voltage (Note 3)

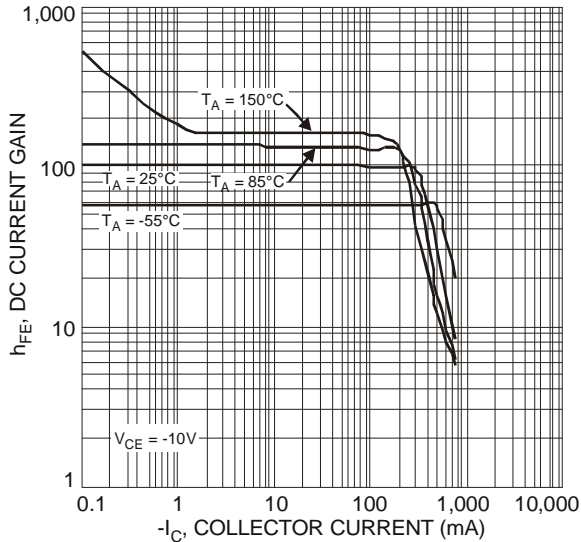

Fig. 3 Typical DC Current Gain vs. Collector Current

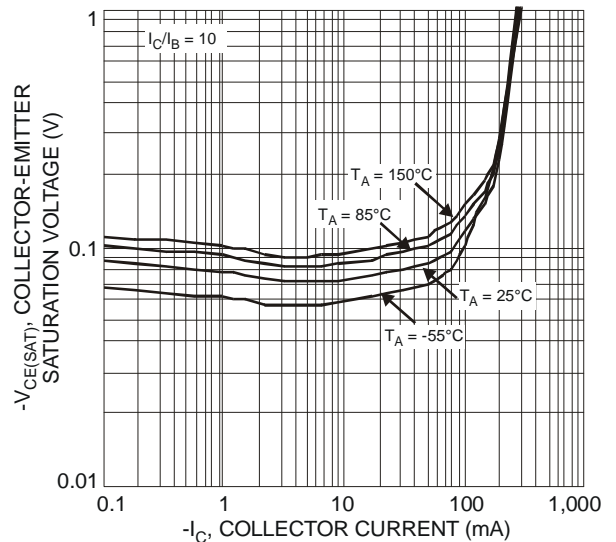

Fig. 4 Typical Collector-Emitter Saturation Voltage vs. Collector Current

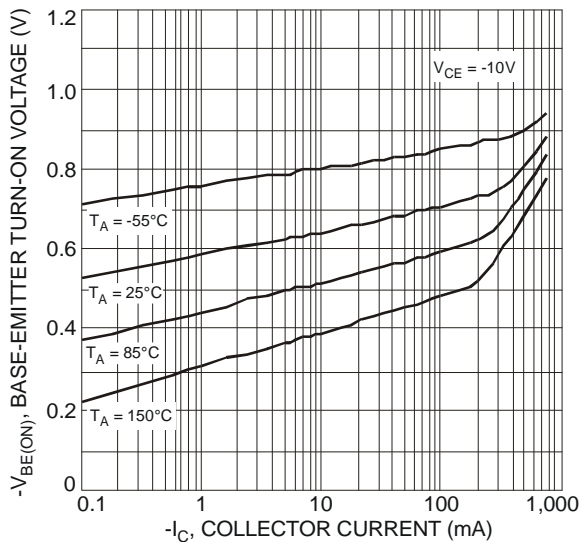

Fig. 5 Typical Base-Emitter Turn-On Voltage vs. Collector Current

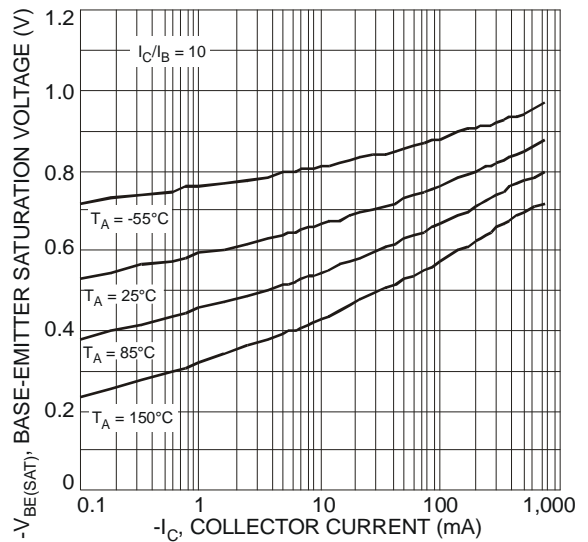

Fig. 6 Typical Base-Emitter Saturation Voltage vs. Collector Current

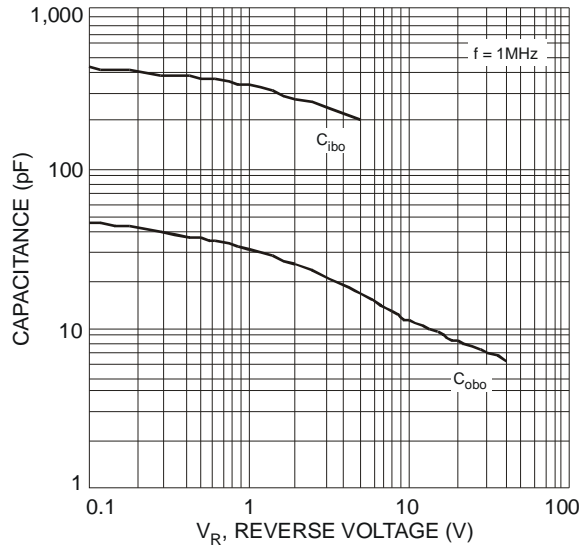

Fig. 7 Typical Capacitance Characteristics

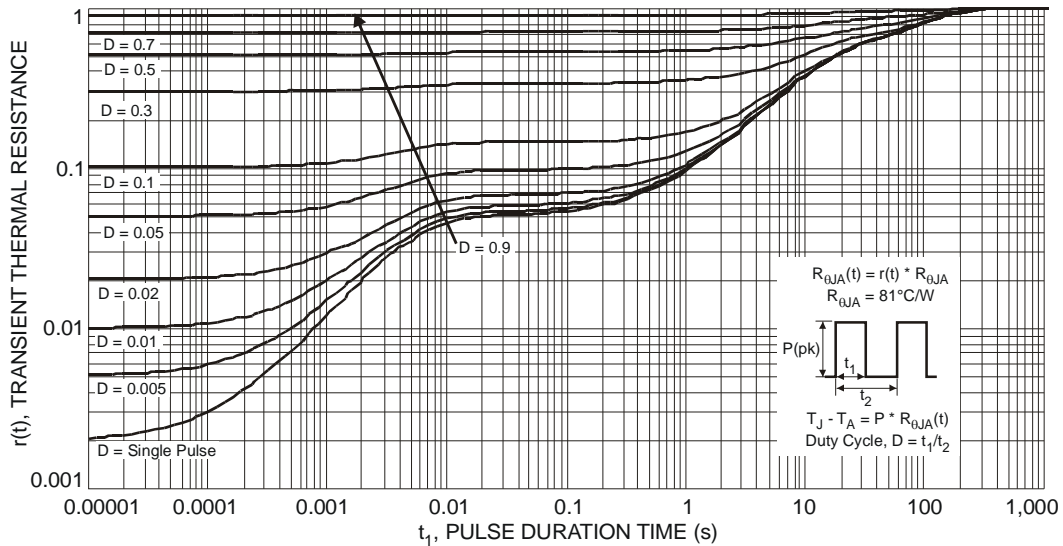

Fig. 8 Transient Thermal Response (Note 3)

Ordering Information (Note 5)

Part Number	Case	Packaging
MJD350-13	DPAK	2500/Tape & Reel

Notes: 5. For packaging details, go to our website at <http://www.diodes.com/datasheets/ap02007.pdf>.

Marking Information

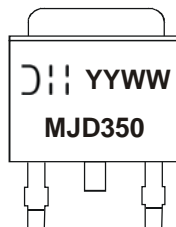

MJD350 = Product Type Marking Code
 D||| = Manufacturers' code marking
 YYWW = Date Code Marking
 YY = Last Digit of Year, (ex: 08 = 2008)
 WW = Week Code 01-52

Package Outline Dimensions

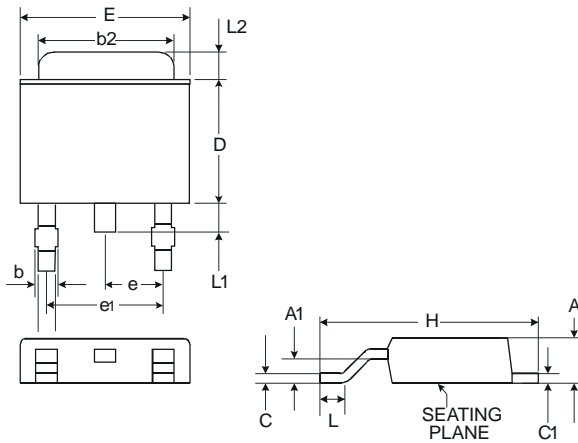

DPAK		
Dim	Min	Max
A	2.18	2.40
A1	0.89	1.14
b	0.61 Typ	
b2	5.20	5.50
C	0.45	0.58
C1	0.45	0.58
D	5.40	6.20
E	6.35	6.80
e	2.28 Typ	
e1	4.57 Typ	
H	9.00	10.40
L	0.51	—
L1	0.64	1.02
L2	0.88	1.27
All Dimensions in mm		

Suggested Pad Layout

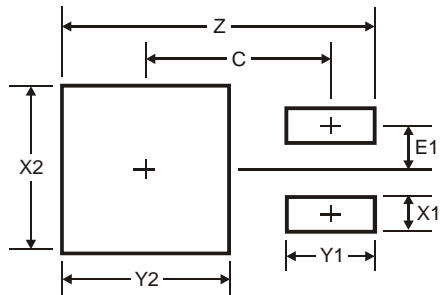

Dimensions	Value (in mm)
Z	11.6
X1	1.5
X2	7.0
Y1	2.5
Y2	7.0
C	6.9
E1	2.3

IMPORTANT NOTICE

Diodes Incorporated and its subsidiaries reserve the right to make modifications, enhancements, improvements, corrections or other changes without further notice to any product herein. Diodes Incorporated does not assume any liability arising out of the application or use of any product described herein; neither does it convey any license under its patent rights, nor the rights of others. The user of products in such applications shall assume all risks of such use and will agree to hold Diodes Incorporated and all the companies whose products are represented on our website, harmless against all damages.

LIFE SUPPORT

Diodes Incorporated products are not authorized for use as critical components in life support devices or systems without the expressed written approval of the President of Diodes Incorporated.