

MJD44H11 (NPN) MJD45H11 (PNP)

Preferred Device

Complementary Power Transistors

DPAK For Surface Mount Applications

Designed for general purpose power and switching such as output or driver stages in applications such as switching regulators, converters, and power amplifiers.

Features

- Lead Formed for Surface Mount Application in Plastic Sleeves (No Suffix)
- Straight Lead Version in Plastic Sleeves (“-1” Suffix)
- Electrically Similar to Popular D44H/D45H Series
- Low Collector Emitter Saturation Voltage –
 $V_{CE(sat)} = 1.0$ Volt Max @ 8.0 Amperes
- Fast Switching Speeds
- Complementary Pairs Simplifies Designs
- Epoxy Meets UL 94 V-0 @ 0.125 in
- ESD Ratings: Human Body Model, 3B > 8000 V
Machine Model, C > 400 V
- Pb-Free Packages are Available

MAXIMUM RATINGS

Rating	Symbol	Max	Unit
Collector-Emitter Voltage	V_{CEO}	80	Vdc
Emitter-Base Voltage	V_{EB}	5	Vdc
Collector Current – Continuous – Peak	I_C	8 16	Adc
Total Power Dissipation @ $T_C = 25^\circ\text{C}$ Derate above 25°C	P_D	20 0.16	W W/ $^\circ\text{C}$
Total Power Dissipation (Note 1) @ $T_A = 25^\circ\text{C}$ Derate above 25°C	P_D	1.75 0.014	W W/ $^\circ\text{C}$
Operating and Storage Junction Temperature Range	T_J, T_{stg}	-55 to +150	$^\circ\text{C}$

THERMAL CHARACTERISTICS

Characteristic	Symbol	Max	Unit
Thermal Resistance, Junction-to-Case	$R_{\theta JC}$	6.25	$^\circ\text{C/W}$
Thermal Resistance, Junction-to-Ambient (Note 1)	$R_{\theta JA}$	71.4	$^\circ\text{C/W}$
Lead Temperature for Soldering	T_L	260	$^\circ\text{C}$

Maximum ratings are those values beyond which device damage can occur. Maximum ratings applied to the device are individual stress limit values (not normal operating conditions) and are not valid simultaneously. If these limits are exceeded, device functional operation is not implied, damage may occur and reliability may be affected.

1. These ratings are applicable when surface mounted on the minimum pad sizes recommended.



ON Semiconductor®

<http://onsemi.com>

SILICON POWER TRANSISTORS 8 AMPERES 80 VOLTS, 20 WATTS

MARKING DIAGRAMS

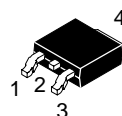

DPAK
CASE 369C
STYLE 1

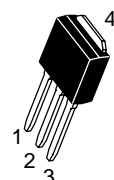
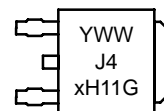

DPAK-3
CASE 369D
STYLE 1

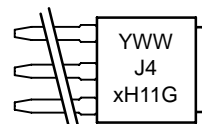

Y = Year
WW = Work Week
J4xH11 = Device Code
x = 4 or 5
G = Pb-Free Package

ORDERING INFORMATION

See detailed ordering and shipping information in the package dimensions section on page 3 of this data sheet.

Preferred devices are recommended choices for future use and best overall value.

MJD44H11 (NPN) MJD45H11 (PNP)

ELECTRICAL CHARACTERISTICS (T_C = 25°C unless otherwise noted)

Characteristic	Symbol	Min	Typ	Max	Unit
----------------	--------	-----	-----	-----	------

OFF CHARACTERISTICS

Collector-Emitter Sustaining Voltage (I _C = 30 mA, I _B = 0)	V _{CEO(sus)}	80	-	-	Vdc
Collector Cutoff Current (V _{CE} = Rated V _{CEO} , V _{BE} = 0)	I _{CES}	-	-	10	μA
Emitter Cutoff Current (V _{EB} = 5 Vdc)	I _{EBO}	-	-	50	μA

ON CHARACTERISTICS

Collector-Emitter Saturation Voltage (I _C = 8 Adc, I _B = 0.4 Adc)	V _{CE(sat)}	-	-	1	Vdc
Base-Emitter Saturation Voltage (I _C = 8 Adc, I _B = 0.8 Adc)	V _{BE(sat)}	-	-	1.5	Vdc
DC Current Gain (V _{CE} = 1 Vdc, I _C = 2 Adc)	h _{FE}	60	-	-	-
DC Current Gain (V _{CE} = 1 Vdc, I _C = 4 Adc)		40	-	-	-

DYNAMIC CHARACTERISTICS

Collector Capacitance (V _{CB} = 10 Vdc, f _{test} = 1 MHz)	C _{cb}	-	130 230	-	pF
Gain Bandwidth Product (I _C = 0.5 Adc, V _{CE} = 10 Vdc, f = 20 MHz)	f _T	-	50 40	-	MHz

SWITCHING TIMES

Delay and Rise Times (I _C = 5 Adc, I _{B1} = 0.5 Adc)	t _d + t _r	-	300 135	-	ns
Storage Time (I _C = 5 Adc, I _{B1} = I _{B2} = 0.5 Adc)	t _s	-	500 500	-	ns
Fall Time (I _C = 5 Adc, I _{B1} = I _{B2} = 0.5 Adc)	t _f	-	140 100	-	ns

MJD44H11 (NPN) MJD45H11 (PNP)

ORDERING INFORMATION

Device	Package Type	Package	Shipping†	
MJD44H11	DPAK	369C	75 Units / Rail	
MJD44H11G	DPAK (Pb-Free)			
MJD44H11-001	DPAK-3	369D		
MJD44H11-001G	DPAK-3 (Pb-Free)			
MJD44H11RL	DPAK	369C	1800 Tape & Reel	
MJD44H11RLG	DPAK (Pb-Free)		2500 Tape & Reel	
MJD44H11T4	DPAK			
MJD44H11T4G	DPAK (Pb-Free)			
MJD44H11T5	DPAK			
MJD44H11T5G	DPAK (Pb-Free)			
MJD45H11	DPAK			75 Units / Rail
MJD45H11G	DPAK (Pb-Free)			
MJD45H11-001	DPAK-3		369D	
MJD45H11-001G	DPAK-3 (Pb-Free)			
MJD45H11RL	DPAK	369C	1800 Tape & Reel	
MJD45H11RLG	DPAK (Pb-Free)		2500 Tape & Reel	
MJD45H11T4	DPAK			
MJD45H11T4G	DPAK (Pb-Free)			

†For information on tape and reel specifications, including part orientation and tape sizes, please refer to our Tape and Reel Packaging Specifications Brochure, BRD8011/D.

MJD44H11 (NPN) MJD45H11 (PNP)

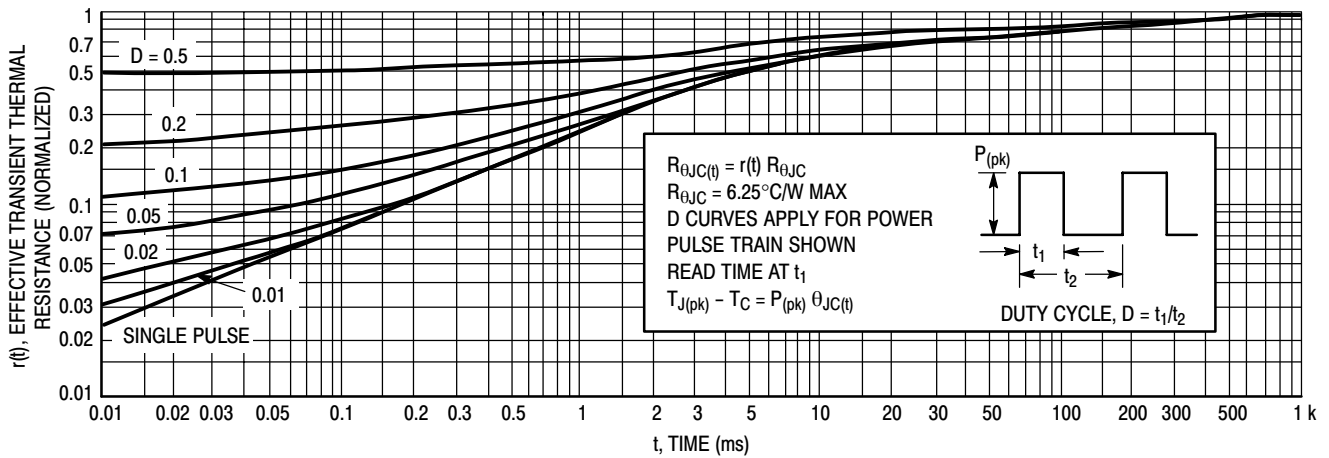

Figure 1. Thermal Response

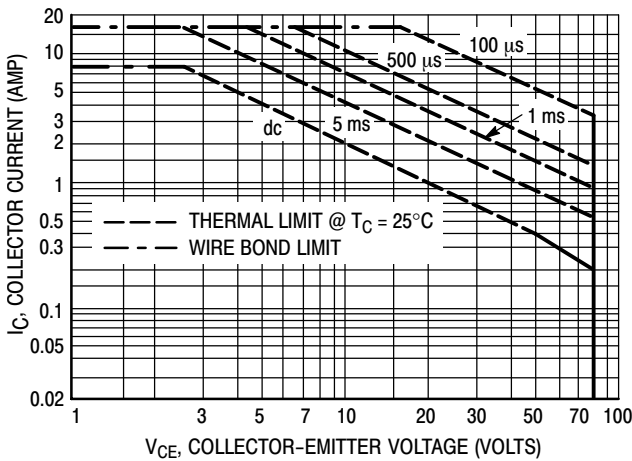

Figure 2. Maximum Forward Bias Safe Operating Area

There are two limitations on the power handling ability of a transistor: average junction temperature and second breakdown. Safe operating area curves indicate $I_C - V_{CE}$ limits of the transistor that must be observed for reliable operation; i.e., the transistor must not be subjected to greater dissipation than the curves indicate.

The data of Figure 2 is based on $T_{J(pk)} = 150^{\circ}\text{C}$; T_C is variable depending on conditions. Second breakdown pulse limits are valid for duty cycles to 10% provided $T_{J(pk)} \leq 150^{\circ}\text{C}$. $T_{J(pk)}$ may be calculated from the data in Figure 1. At high case temperatures, thermal limitations will reduce the power that can be handled to values less than the limitations imposed by second breakdown.

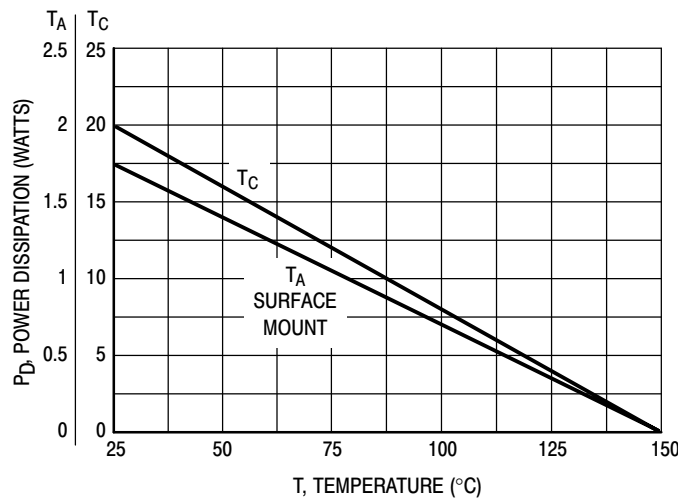

Figure 3. Power Derating

MJD44H11 (NPN) MJD45H11 (PNP)

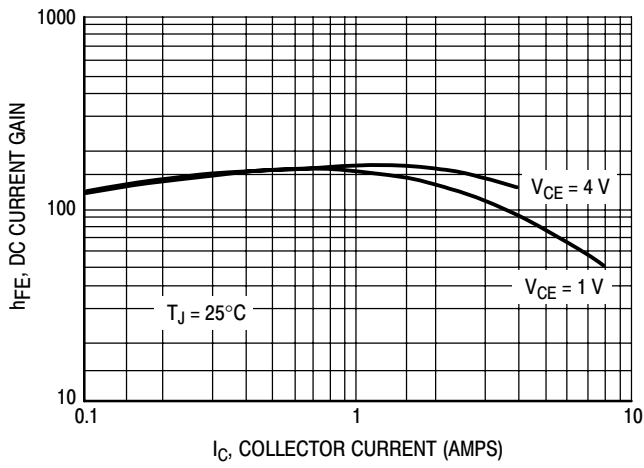

Figure 4. MJD44H11 DC Current Gain

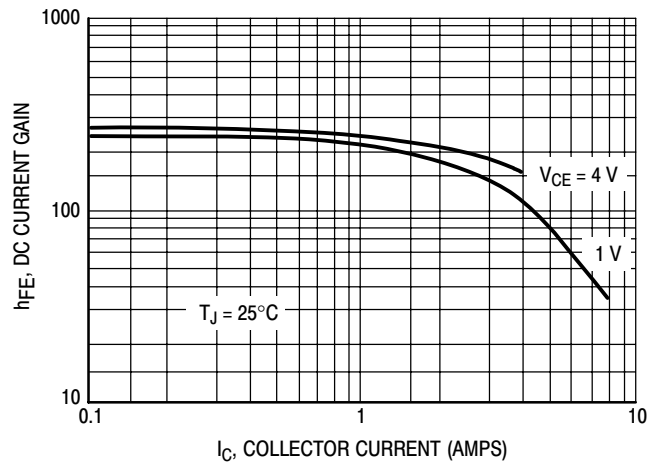

Figure 5. MJD45H11 DC Current Gain

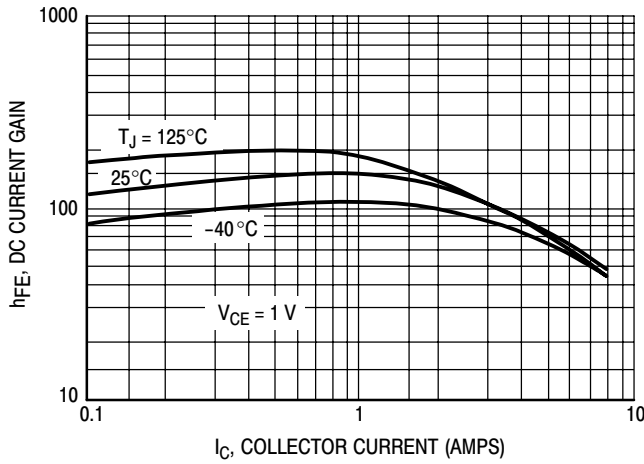

Figure 6. MJD44H11 Current Gain versus Temperature

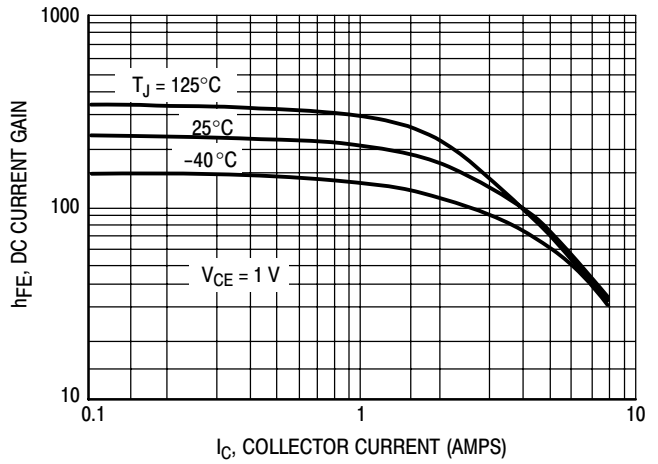

Figure 7. MJD45H11 Current Gain versus Temperature

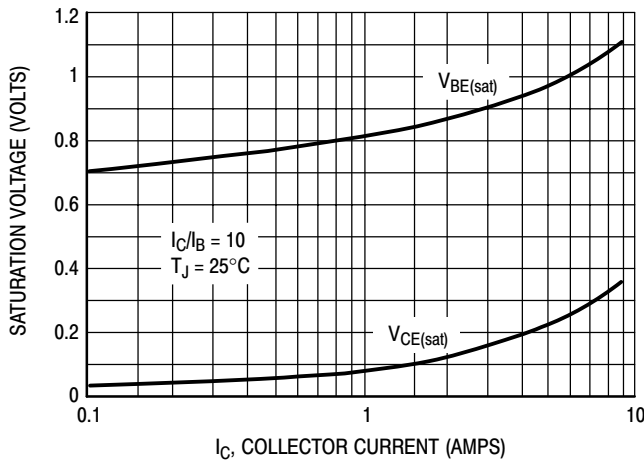

Figure 8. MJD44H11 On-Voltages

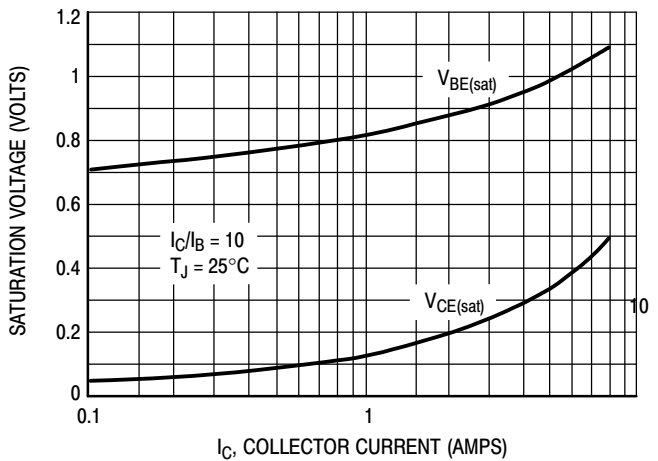
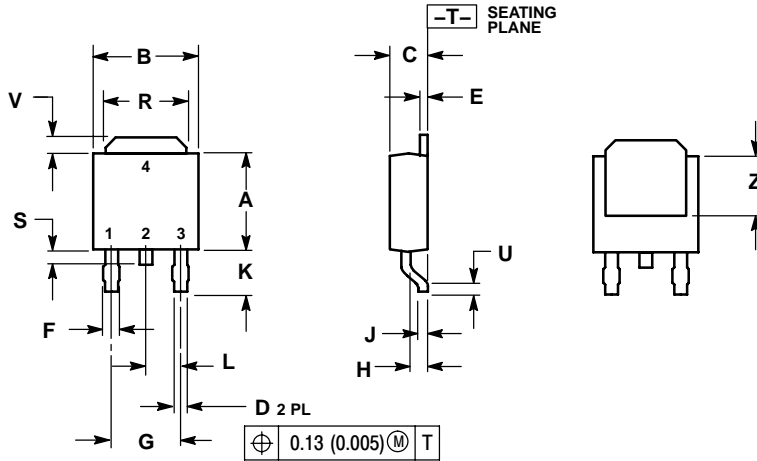

Figure 9. MJD45H11 On-Voltages

MJD44H11 (NPN) MJD45H11 (PNP)

PACKAGE DIMENSIONS

DPAK
CASE 369C
ISSUE O



- NOTES:
1. DIMENSIONING AND TOLERANCING PER ANSI Y14.5M, 1982.
2. CONTROLLING DIMENSION: INCH.

DIM	INCHES		MILLIMETERS	
	MIN	MAX	MIN	MAX
A	0.235	0.245	5.97	6.22
B	0.250	0.265	6.35	6.73
C	0.086	0.094	2.19	2.38
D	0.027	0.035	0.69	0.88
E	0.018	0.023	0.46	0.58
F	0.037	0.045	0.94	1.14
G	0.180 BSC		4.58 BSC	
H	0.034	0.040	0.87	1.01
J	0.018	0.023	0.46	0.58
K	0.102	0.114	2.60	2.89
L	0.090 BSC		2.29 BSC	
R	0.180	0.215	4.57	5.45
S	0.025	0.040	0.63	1.01
U	0.020	---	0.51	---
V	0.035	0.050	0.89	1.27
Z	0.155	---	3.93	---

- STYLE 1:
PIN 1. BASE
2. COLLECTOR
3. EMITTER
4. COLLECTOR

SOLDERING FOOTPRINT*

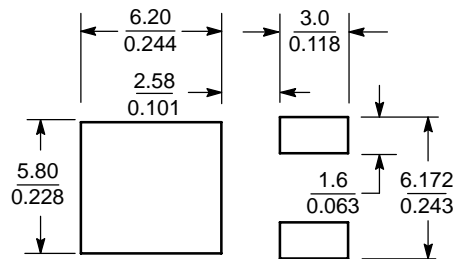

SCALE 3:1 $\left(\frac{\text{mm}}{\text{inches}}\right)$

*For additional information on our Pb-Free strategy and soldering details, please download the ON Semiconductor Soldering and Mounting Techniques Reference Manual, SOLDERRM/D.

MJD44H11 (NPN) MJD45H11 (PNP)

PACKAGE DIMENSIONS

DKPAK-3
CASE 369D-01
ISSUE B

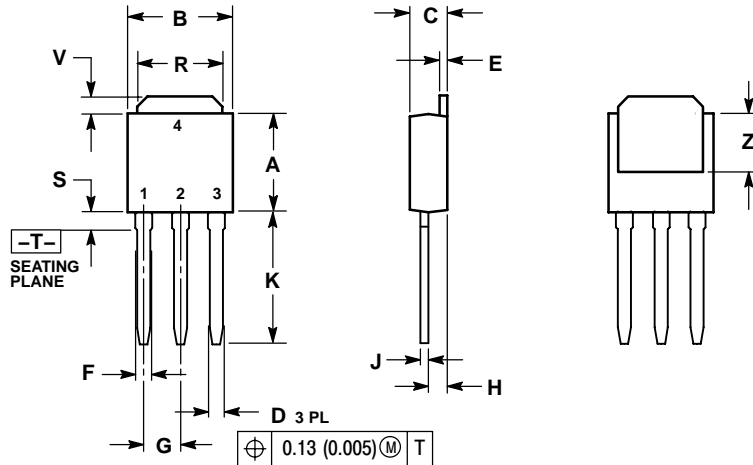

NOTES:

1. DIMENSIONING AND TOLERANCING PER ANSI Y14.5M, 1982.
2. CONTROLLING DIMENSION: INCH.

DIM	INCHES		MILLIMETERS	
	MIN	MAX	MIN	MAX
A	0.235	0.245	5.97	6.35
B	0.250	0.265	6.35	6.73
C	0.086	0.094	2.19	2.38
D	0.027	0.035	0.69	0.88
E	0.018	0.023	0.46	0.58
F	0.037	0.045	0.94	1.14
G	0.090 BSC		2.29 BSC	
H	0.034	0.040	0.87	1.01
J	0.018	0.023	0.46	0.58
K	0.350	0.380	8.89	9.65
R	0.180	0.215	4.45	5.45
S	0.025	0.040	0.63	1.01
V	0.035	0.050	0.89	1.27
Z	0.155	---	3.93	---

STYLE 1:

- PIN 1. BASE
2. COLLECTOR
3. EMITTER
4. COLLECTOR

ON Semiconductor and are registered trademarks of Semiconductor Components Industries, LLC (SCILLC). SCILLC reserves the right to make changes without further notice to any products herein. SCILLC makes no warranty, representation or guarantee regarding the suitability of its products for any particular purpose, nor does SCILLC assume any liability arising out of the application or use of any product or circuit, and specifically disclaims any and all liability, including without limitation special, consequential or incidental damages. "Typical" parameters which may be provided in SCILLC data sheets and/or specifications can and do vary in different applications and actual performance may vary over time. All operating parameters, including "Typicals" must be validated for each customer application by customer's technical experts. SCILLC does not convey any license under its patent rights nor the rights of others. SCILLC products are not designed, intended, or authorized for use as components in systems intended for surgical implant into the body, or other applications intended to support or sustain life, or for any other application in which the failure of the SCILLC product could create a situation where personal injury or death may occur. Should Buyer purchase or use SCILLC products for any such unintended or unauthorized application, Buyer shall indemnify and hold SCILLC and its officers, employees, subsidiaries, affiliates, and distributors harmless against all claims, costs, damages, and expenses, and reasonable attorney fees arising out of, directly or indirectly, any claim of personal injury or death associated with such unintended or unauthorized use, even if such claim alleges that SCILLC was negligent regarding the design or manufacture of the part. SCILLC is an Equal Opportunity/Affirmative Action Employer. This literature is subject to all applicable copyright laws and is not for resale in any manner.

PUBLICATION ORDERING INFORMATION

LITERATURE FULFILLMENT:
Literature Distribution Center for ON Semiconductor
P.O. Box 61312, Phoenix, Arizona 85082-1312 USA
Phone: 480-829-7710 or 800-344-3860 Toll Free USA/Canada
Fax: 480-829-7709 or 800-344-3867 Toll Free USA/Canada
Email: orderlit@onsemi.com

N. American Technical Support: 800-282-9855 Toll Free
USA/Canada

Japan: ON Semiconductor, Japan Customer Focus Center
2-9-1 Kamimeguro, Meguro-ku, Tokyo, Japan 153-0051
Phone: 81-3-5773-3850

ON Semiconductor Website: <http://onsemi.com>

Order Literature: <http://www.onsemi.com/litorder>

For additional information, please contact your local Sales Representative.