

SWITCHMODE™ NPN Silicon Planar Power Transistor

The MJE/MJF18009 has an application specific state-of-the-art die designed for use in 220 V line-operated SWITCHMODE Power supplies and electronic ballast (“light ballast”). These high voltage/high speed transistors exhibit the following main features:

- Improved Efficiency Due to Low Base Drive Requirements:
 - High and Flat DC Current Gain h_{FE}
 - Fast Switching
 - No Coil Required in Base Circuit for Turn-Off (No Current Tail)
- Full Characterization at 125°C
- ON Semiconductor “6 SIGMA” Philosophy Provides Tight and Reproducible Parametric Distributions
- Specified Dynamic Saturation Data
- Two Package Choices: Standard TO-220 or Isolated TO-220

MAXIMUM RATINGS

Rating	Symbol	MJE18009	MJF18009	Unit
Collector-Emitter Sustaining Voltage	V_{CEO}	450		Vdc
Collector-Emitter Breakdown Voltage	V_{CES}	1000		Vdc
Collector-Base Breakdown Voltage	V_{CBO}	1000		Vdc
Emitter-Base Voltage	V_{EBO}	9		Vdc
Collector Current — Continuous	I_C	10		Adc
— Peak (1)	I_{CM}	20		
Base Current — Continuous	I_B	4		Adc
— Peak (1)	I_{BM}	8		
*Total Device Dissipation @ $T_C = 25^\circ\text{C}$	P_D	150	50	Watt
*Derate above 25°C		1.2	0.4	W/°C
Operating and Storage Temperature	T_J, T_{stg}	-65 to 150		°C
RMS Isolation Voltage (2)	V_{ISOL1}	4500		V
(1s, 25°C, Humidity ≤ 30%)	V_{ISOL2}	3500		
$T_C = 25^\circ\text{C}$	V_{ISOL3}	1500		

THERMAL CHARACTERISTICS

Rating	Symbol	MJE18009	MJF18009	Unit
Thermal Resistance — Junction to Case	$R_{\theta JC}$	0.83	2.5	°C/W
— Junction to Ambient	$R_{\theta JA}$	62.5	62.5	
Maximum Lead Temperature for Soldering Purposes: 1/8" from Case for 5 Seconds	T_L	260		°C

- (1) Pulse Test: Pulse Width = 5 ms, Duty Cycle ≤ 10%.
 (2) Proper strike and creepage distance must be provided.

MJE18009
MJF18009

POWER TRANSISTORS
10 AMPERES
1000 VOLTS
50 and 150 WATTS

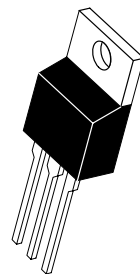
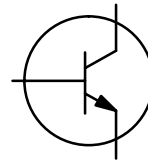

CASE 221A-06
TO-220AB

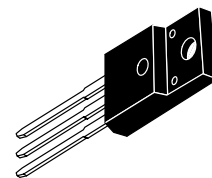

CASE 221D-02
TO-220 FULLPACK

MJE18009 MJF18009

ELECTRICAL CHARACTERISTICS ($T_C = 25^\circ\text{C}$ unless otherwise noted)

Characteristic	Symbol	Min	Typ	Max	Unit
----------------	--------	-----	-----	-----	------

OFF CHARACTERISTICS

Collector–Emitter Sustaining Voltage ($I_C = 100\text{ mA}$, $L = 25\text{ mH}$)	$V_{CEO(sus)}$	450			Vdc
Collector Cutoff Current ($V_{CE} = \text{Rated } V_{CEO}$, $I_B = 0$)	I_{CEO}			100	μA_{dc}
Collector Cutoff Current ($V_{CE} = \text{Rated } V_{CES}$, $V_{EB} = 0$) ($V_{CE} = 800\text{ V}$, $V_{EB} = 0$)	I_{CES}	@ $T_C = 25^\circ\text{C}$ @ $T_C = 125^\circ\text{C}$ @ $T_C = 125^\circ\text{C}$		100 500 100	μA_{dc}
Emitter–Cutoff Current ($V_{EB} = 9\text{ Vdc}$, $I_C = 0$)	I_{EBO}			100	μA_{dc}

ON CHARACTERISTICS

Base–Emitter Saturation Voltage ($I_C = 3\text{ Adc}$, $I_B = 0.3\text{ Adc}$) ($I_C = 5\text{ Adc}$, $I_B = 1\text{ Adc}$) ($I_C = 7\text{ Adc}$, $I_B = 1.4\text{ Adc}$)	$V_{BE(sat)}$		0.8 0.9 0.9	1.1 1.15 1.25	Vdc
Collector–Emitter Saturation Voltage ($I_C = 3\text{ Adc}$, $I_B = 0.3\text{ Adc}$) ($I_C = 5\text{ Adc}$, $I_B = 1\text{ Adc}$) ($I_C = 7\text{ Adc}$, $I_B = 1.4\text{ Adc}$)	$V_{CE(sat)}$	@ $T_C = 25^\circ\text{C}$ @ $T_C = 125^\circ\text{C}$ @ $T_C = 25^\circ\text{C}$ @ $T_C = 125^\circ\text{C}$ @ $T_C = 25^\circ\text{C}$ @ $T_C = 125^\circ\text{C}$	0.3 0.3 0.3 0.3 0.35 0.4	0.6 0.65 0.6 0.65 0.7 0.9	Vdc
DC Current Gain ($I_C = 1.5\text{ Adc}$, $V_{CE} = 5\text{ Vdc}$) ($I_C = 5\text{ Adc}$, $V_{CE} = 1\text{ Vdc}$) ($I_C = 7\text{ Adc}$, $V_{CE} = 1\text{ Vdc}$) ($I_C = 10\text{ mAdc}$, $V_{CE} = 5\text{ Vdc}$)	h_{FE}	@ $T_C = 25^\circ\text{C}$ @ $T_C = 125^\circ\text{C}$ @ $T_C = 25^\circ\text{C}$ @ $T_C = 125^\circ\text{C}$ @ $T_C = 25^\circ\text{C}$ @ $T_C = 125^\circ\text{C}$ @ $T_C = 25^\circ\text{C}$	14 10 8 7 5 10	29 13 11.5 10 7.5 25	— — —

DYNAMIC CHARACTERISTICS

Current Gain Bandwidth ($I_C = 0.5\text{ Adc}$, $V_{CE} = 10\text{ Vdc}$, $f = 1\text{ MHz}$)	f_T		12		MHz
Output Capacitance ($V_{CB} = 10\text{ Vdc}$, $I_E = 0$, $f = 1\text{ MHz}$)	C_{ob}		150	200	pF
Input Capacitance ($V_{EB} = 8\text{ Vdc}$)	C_{ib}		2750	3500	pF

DYNAMIC SATURATION VOLTAGE

Dynamic Saturation Voltage: Determined 1 μs and 3 μs respectively after rising I_{B1} reaches 90% of final I_{B1}	$I_C = 3\text{ Adc}$ $I_{B1} = 300\text{ mAdc}$ $V_{CC} = 300\text{ V}$	@ 1 μs	@ $T_C = 25^\circ\text{C}$ @ $T_C = 125^\circ\text{C}$	$V_{CE(dsat)}$	8 13.5	V
		@ 3 μs	@ $T_C = 25^\circ\text{C}$ @ $T_C = 125^\circ\text{C}$		4 8	
	$I_C = 7\text{ Adc}$ $I_{B1} = 1.4\text{ Adc}$ $V_{CC} = 300\text{ V}$	@ 1 μs	@ $T_C = 25^\circ\text{C}$ @ $T_C = 125^\circ\text{C}$		15 21	
		@ 3 μs	@ $T_C = 25^\circ\text{C}$ @ $T_C = 125^\circ\text{C}$		2 2.7	

MJE18009 MJF18009

ELECTRICAL CHARACTERISTICS ($T_C = 25^\circ\text{C}$ unless otherwise noted)

Characteristic	Symbol	Min	Typ	Max	Unit
----------------	--------	-----	-----	-----	------

SWITCHING CHARACTERISTICS: Resistive Load ($D.C. \leq 10\%$, Pulse Width = 20 μs)

Turn-on Time	$I_C = 3 \text{ Adc}$, $I_{B1} = 0.3 \text{ Adc}$ $I_{B2} = 1.5 \text{ Adc}$ $V_{CC} = 300 \text{ Vdc}$	@ $T_C = 25^\circ\text{C}$	t_{on}		220	300	ns
Turn-off Time		@ $T_C = 25^\circ\text{C}$ @ $T_C = 125^\circ\text{C}$	t_{off}		1.28 1.6	2.5	μs
Turn-on Time	$I_C = 5 \text{ Adc}$, $I_{B1} = 1 \text{ Adc}$ $I_{B2} = 2.5 \text{ Adc}$ $V_{CC} = 300 \text{ Vdc}$	@ $T_C = 25^\circ\text{C}$	t_{on}		120	250	ns
Turn-off Time		@ $T_C = 25^\circ\text{C}$ @ $T_C = 125^\circ\text{C}$	t_{off}		2.2 2.6	2.5	μs
Turn-on Time	$I_C = 7 \text{ Adc}$, $I_{B1} = 1.4 \text{ Adc}$ $I_{B2} = 3.5 \text{ Adc}$ $V_{CC} = 300 \text{ Vdc}$	@ $T_C = 25^\circ\text{C}$	t_{on}		175	300	ns
Turn-off Time		@ $T_C = 25^\circ\text{C}$ @ $T_C = 125^\circ\text{C}$	t_{off}		1.75 2.1	2.5	μs

SWITCHING CHARACTERISTICS: Inductive Load ($V_{clamp} = 300 \text{ V}$, $V_{CC} = 15 \text{ V}$, $L = 200 \mu\text{H}$)

Fall Time	$I_C = 3 \text{ Adc}$ $I_{B1} = 0.3 \text{ Adc}$ $I_{B2} = 1.5 \text{ Adc}$	@ $T_C = 25^\circ\text{C}$	t_f		110	200	ns
Storage Time		@ $T_C = 25^\circ\text{C}$ @ $T_C = 125^\circ\text{C}$	t_s		2 2.6	2.75	μs
Crossover Time		@ $T_C = 25^\circ\text{C}$ @ $T_C = 125^\circ\text{C}$	t_c		250 300	350	ns
Fall Time	$I_C = 5 \text{ Adc}$ $I_{B1} = 1 \text{ Adc}$ $I_{B2} = 2.5 \text{ Adc}$	@ $T_C = 25^\circ\text{C}$	t_f		110	200	ns
Storage Time		@ $T_C = 25^\circ\text{C}$ @ $T_C = 125^\circ\text{C}$	t_s		2.4 3.1	3.5	μs
Crossover Time		@ $T_C = 25^\circ\text{C}$ @ $T_C = 125^\circ\text{C}$	t_c		260 300	350	ns
Fall Time	$I_C = 7 \text{ Adc}$ $I_{B1} = 1.4 \text{ Adc}$ $I_{B2} = 3.5 \text{ Adc}$	@ $T_C = 25^\circ\text{C}$	t_f		105	200	ns
Storage Time		@ $T_C = 25^\circ\text{C}$ @ $T_C = 125^\circ\text{C}$	t_s		1.75 2.25	2.75	μs
Crossover Time		@ $T_C = 25^\circ\text{C}$ @ $T_C = 125^\circ\text{C}$	t_c		225 300	350	ns

TYPICAL STATIC CHARACTERISTICS

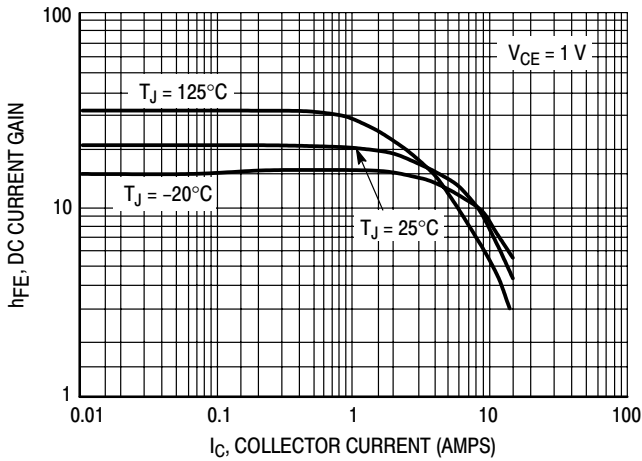

Figure 1. DC Current Gain @ 1 Volt

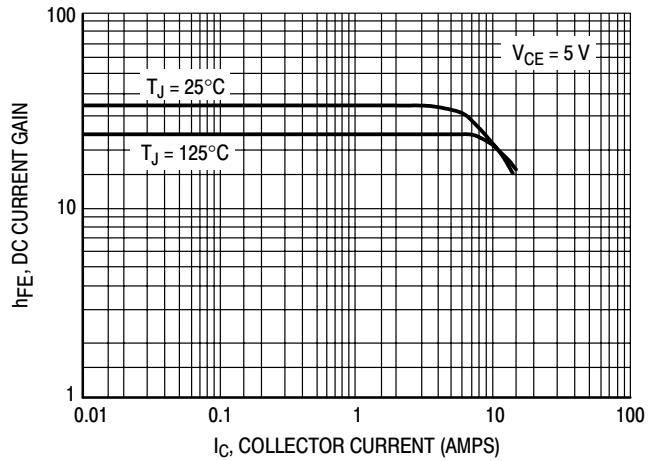

Figure 2. DC Current Gain @ 5 Volt

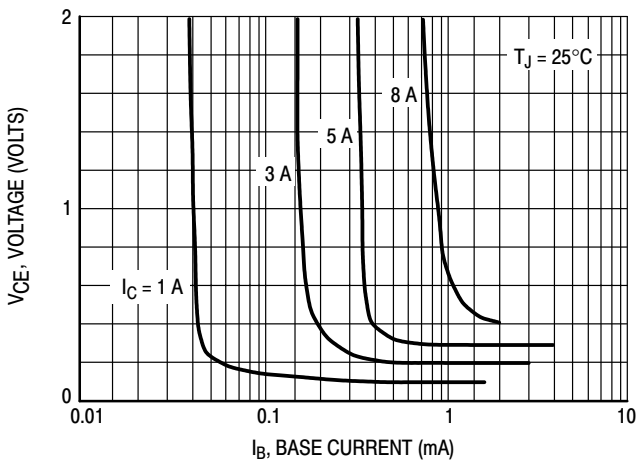

Figure 3. Collector Saturation Region

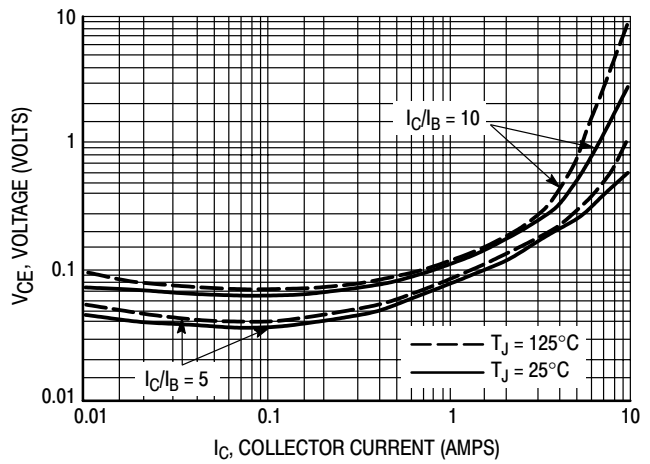

Figure 4. Collector-Emitter Saturation Voltage

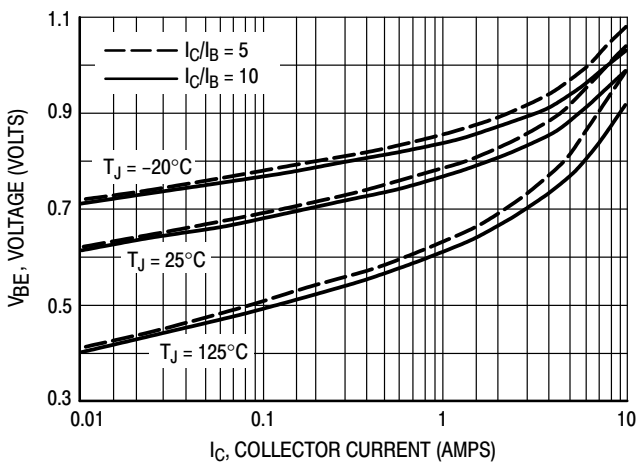

Figure 5. Base-Emitter Saturation Region

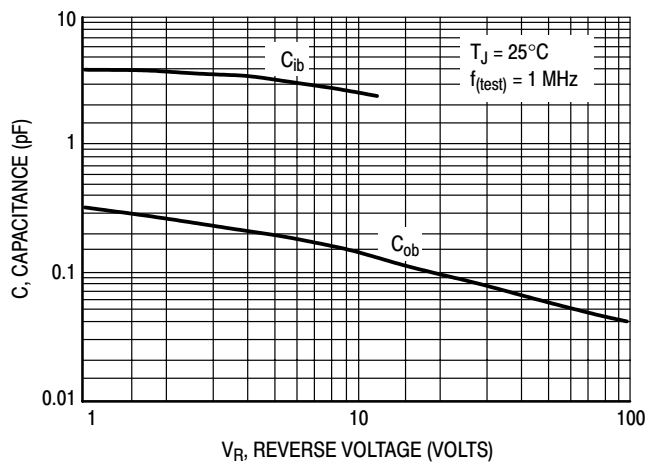

Figure 6. Capacitance

TYPICAL SWITCHING CHARACTERISTICS

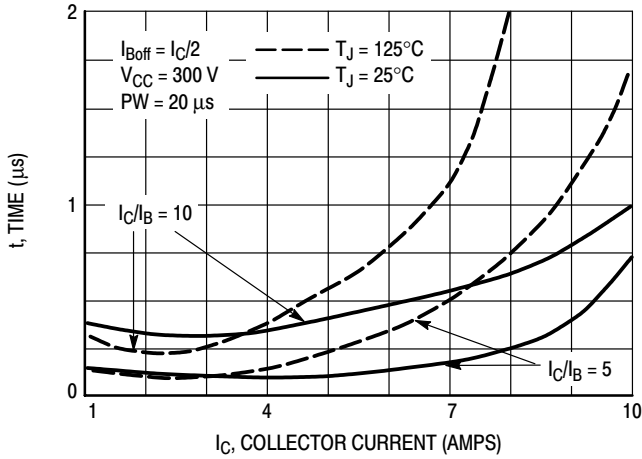

Figure 7. Resistive Switching, t_{on}

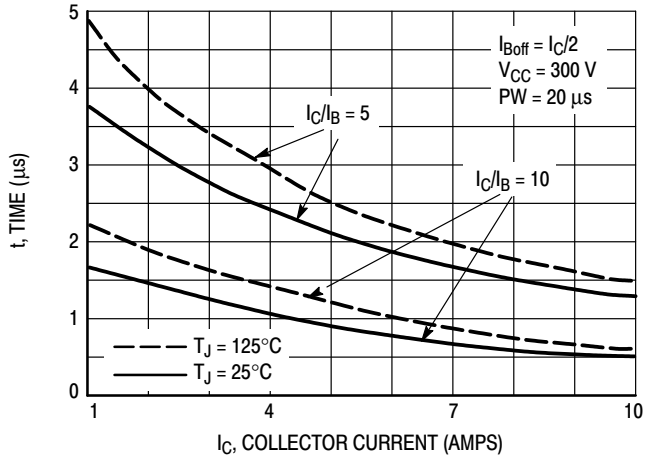

Figure 8. Resistive Switching, t_{off}

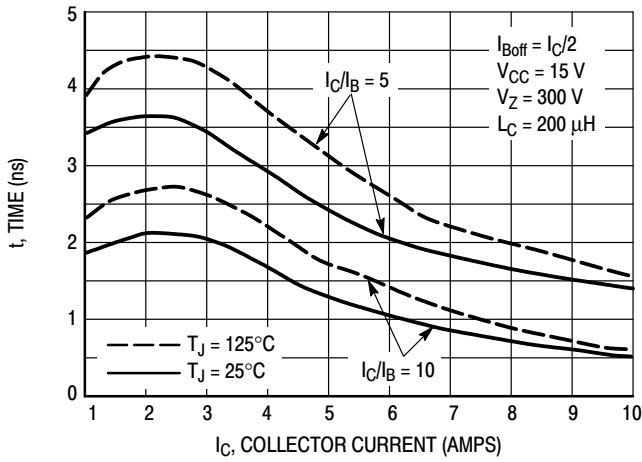

Figure 9. Inductive Storage Time, t_{si}

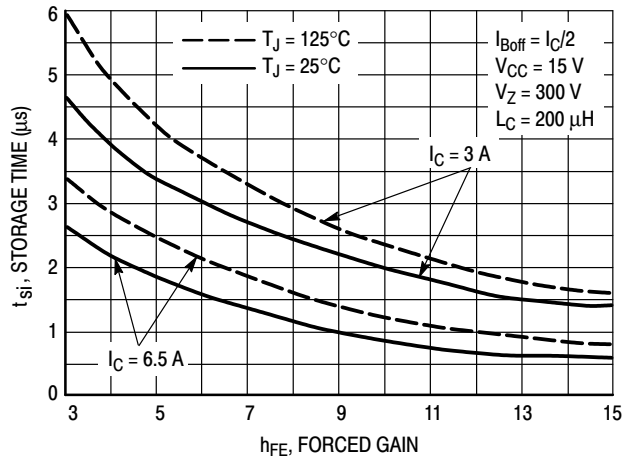

Figure 10. Inductive Storage Time

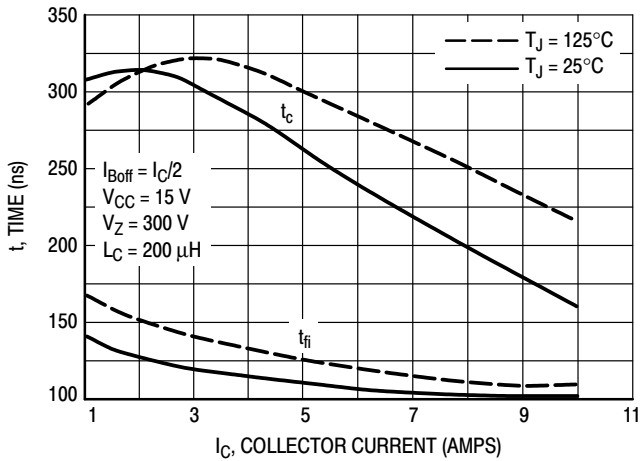

Figure 11. Inductive Switching, t_c and t_{fi} @ $I_C/I_B = 5$

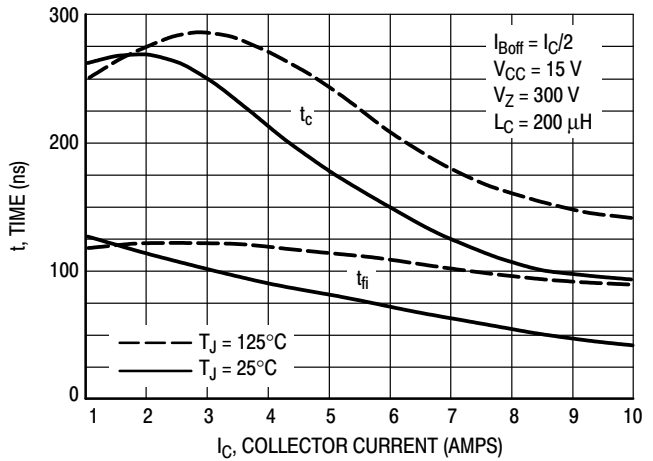

Figure 12. Inductive Switching, t_c and t_{fi} @ $I_C/I_B = 10$

MJE18009 MJF18009

TYPICAL SWITCHING CHARACTERISTICS

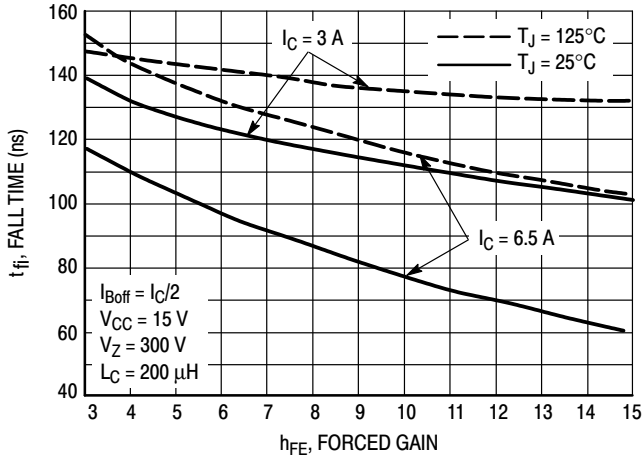

Figure 13. Inductive Fall Time

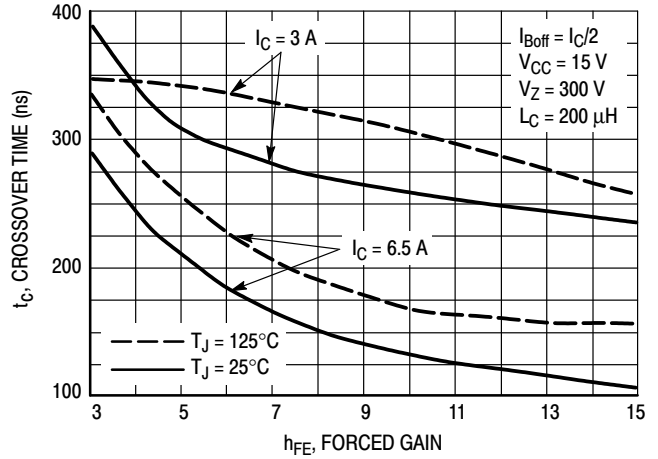

Figure 14. Inductive Crossover Time

TYPICAL CHARACTERISTICS

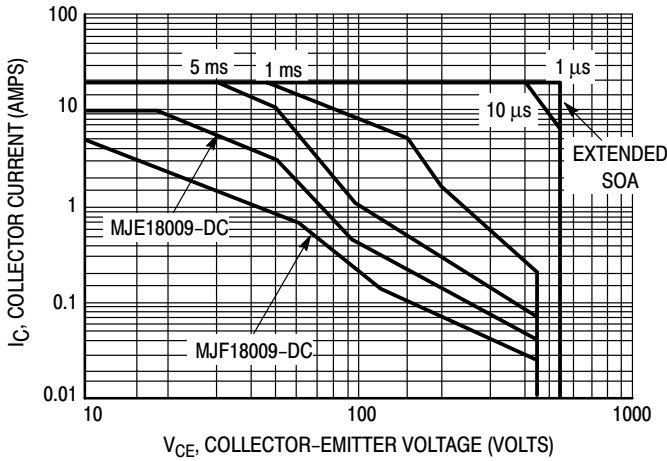

Figure 15. Forward Bias Safe Operating Area

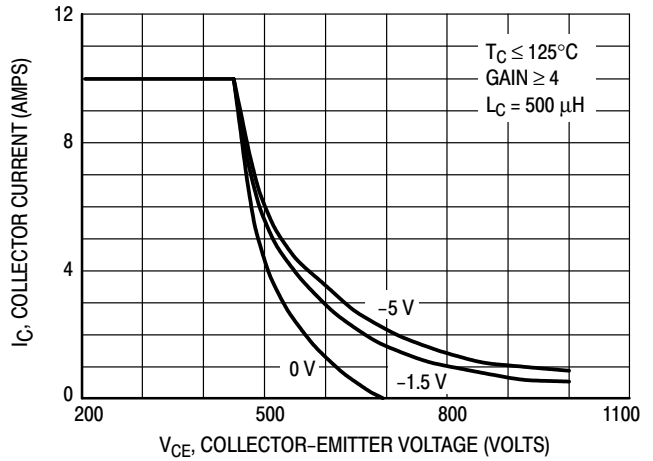

Figure 16. Reverse Bias Switching Safe Operating Area

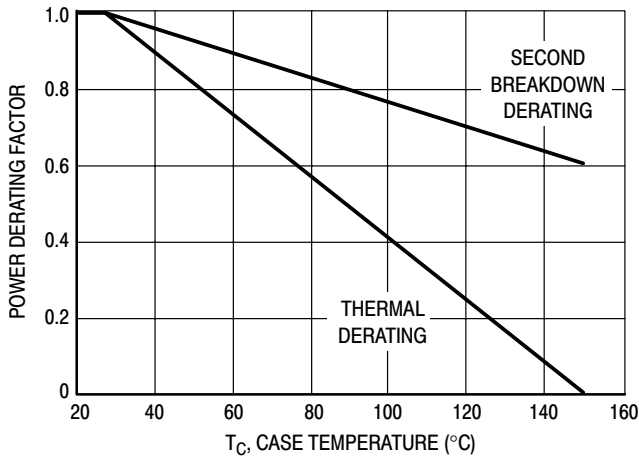

Figure 17. Forward Bias Power Derating

There are two limitations on the power handling ability of a transistor: average junction temperature and second breakdown. Safe operating area curves indicate I_C - V_{CE} limits of the transistor that must be observed for reliable operation; i.e., the transistor must not be subjected to greater dissipation than the curves indicate. The data of Figure 15 is based on $T_C = 25^\circ\text{C}$; $T_J(\text{pk})$ is variable depending on power level. Second breakdown pulse limits are valid for duty cycles to 10% but must be derated when $T_C > 25^\circ\text{C}$. Second breakdown limitations do not derate the same as thermal limitations. Allowable current at the voltages shown on Figure 15 may be found at any case temperature by using the appropriate curve on Figure 17.

$T_J(\text{pk})$ may be calculated from the data in Figures 20 and 21. At any case temperatures, thermal limitations will reduce the power that can be handled to values less than the limitations imposed by second breakdown. For inductive loads, high voltage and current must be sustained simultaneously during turn-off with the base-to-emitter junction reverse biased. The safe level is specified as a reverse-biased safe operating area (Figure 16). This rating is verified under clamped conditions so that the device is never subjected to an avalanche mode.

TYPICAL SWITCHING CHARACTERISTICS
($I_B = I_C/2$ FOR ALL CURVES)

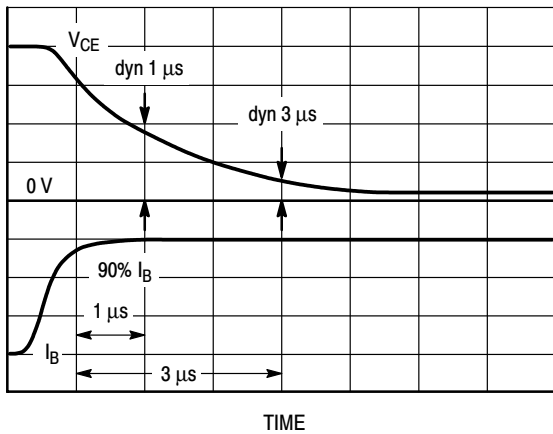

Figure 18. Dynamic Saturation Voltage Measurements

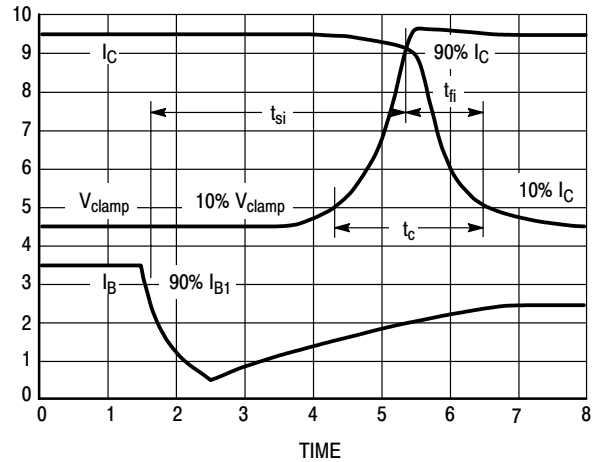
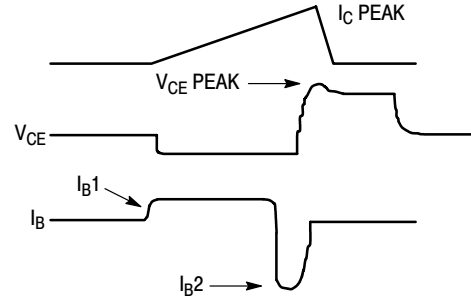
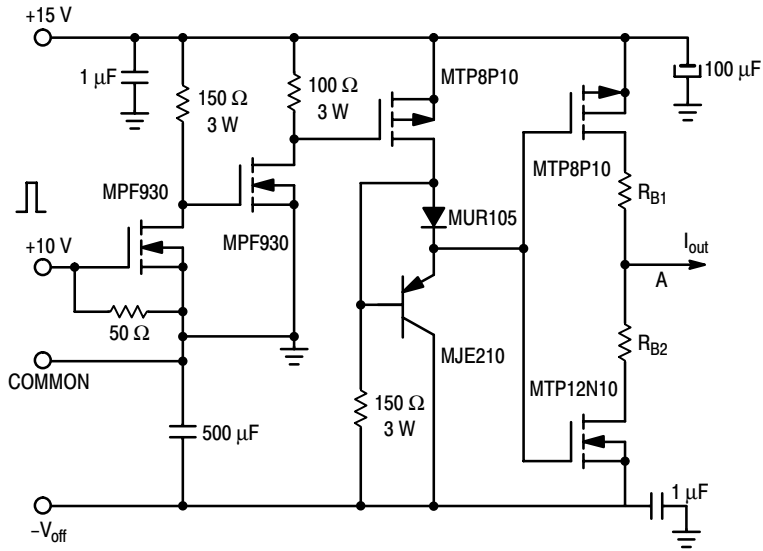

Figure 19. Inductive Switching Measurements

MJE18009 MJF18009

Table 1. Inductive Load Switching Drive Circuit



V_{(BR)CEO(sus)}
 $L = 10 \text{ mH}$
 $R_{B2} = \infty$
 $V_{CC} = 20 \text{ Volts}$
 $I_{C(pk)} = 100 \text{ mA}$

Inductive Switching
 $L = 200 \mu\text{H}$
 $R_{B2} = 0$
 $V_{CC} = 15 \text{ Volts}$
 R_{B1} selected for
 desired I_{B1}

RBSOA
 $L = 500 \mu\text{H}$
 $R_{B2} = 0$
 $V_{CC} = 15 \text{ Volts}$
 R_{B1} selected for
 desired I_{B1}

MJE18009 MJF18009

TYPICAL THERMAL RESPONSE ($I_B = I_C/2$ FOR ALL CURVES)

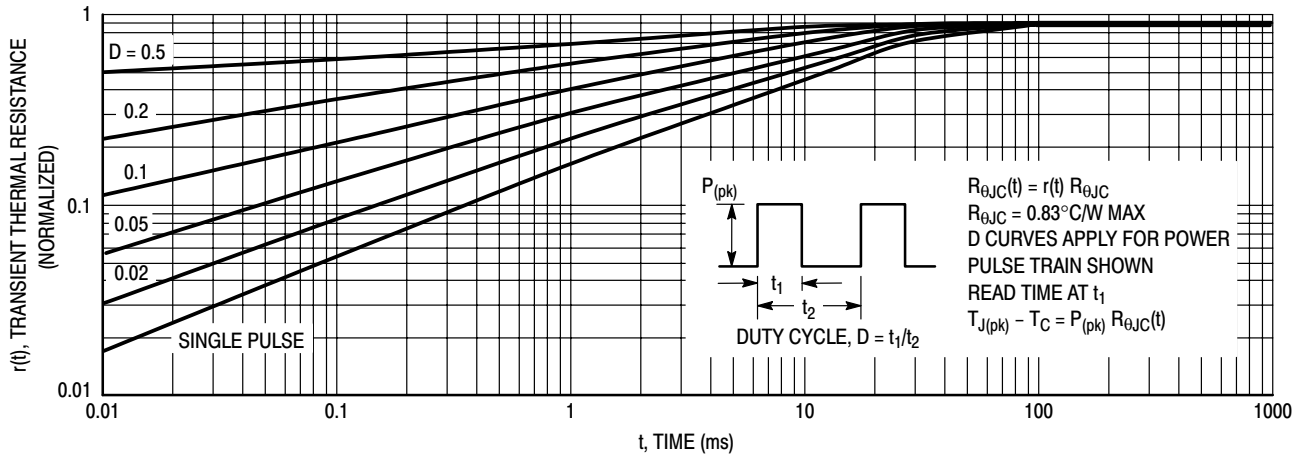

Figure 20. Typical Thermal Response ($Z_{\theta JC}(t)$) for MJE18009

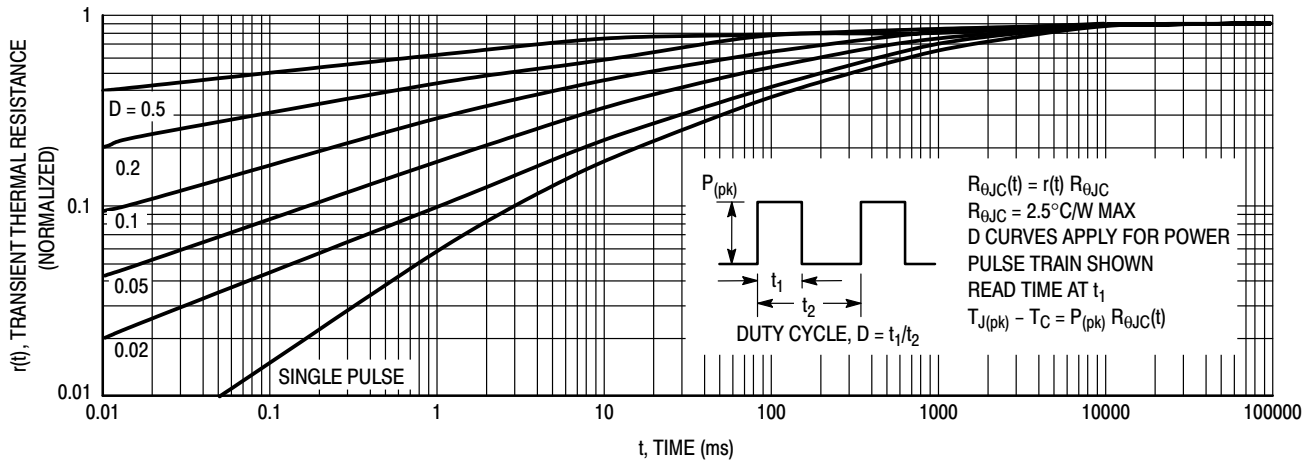

Figure 21. Typical Thermal Response ($Z_{\theta JC}(t)$) for MJF18009

TEST CONDITIONS FOR ISOLATION TESTS*

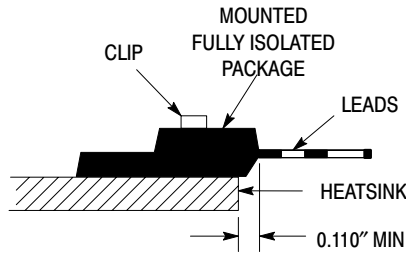

Figure 22. Clip Mounting Position for Isolation Test Number 1

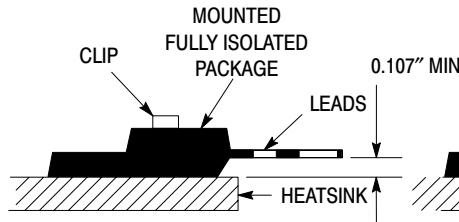

Figure 23. Clip Mounting Position for Isolation Test Number 2

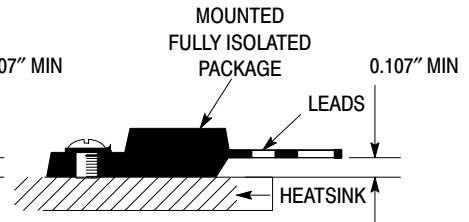

Figure 24. Screw Mounting Position for Isolation Test Number 3

*Measurement made between leads and heatsink with all leads shorted together

MOUNTING INFORMATION**

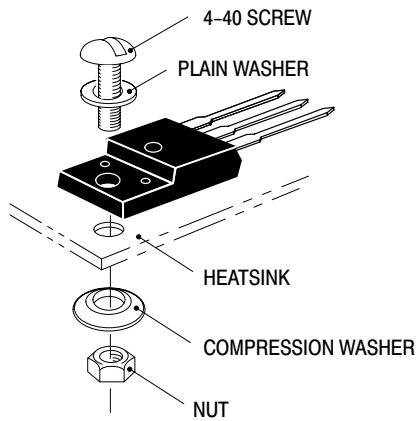

Figure 25a. Screw-Mounted

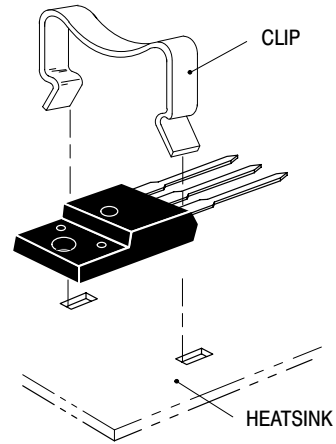

Figure 25b. Clip-Mounted

Figure 25. Typical Mounting Techniques for Isolated Package

Laboratory tests on a limited number of samples indicate, when using the screw and compression washer mounting technique, a screw torque of 6 to 8 in · lbs is sufficient to provide maximum power dissipation capability. The compression washer helps to maintain a constant pressure on the package over time and during large temperature excursions.

Destructive laboratory tests show that using a hex head 4-40 screw, without washers, and applying a torque in excess of 20 in · lbs will cause the plastic to crack around the mounting hole, resulting in a loss of isolation capability.

Additional tests on slotted 4-40 screws indicate that the screw slot fails between 15 to 20 in · lbs without adversely affecting the package. However, in order to positively ensure the package integrity of the fully isolated device, ON Semiconductor does not recommend exceeding 10 in · lbs of mounting torque under any mounting conditions.

MJE18009 MJF18009

PACKAGE DIMENSIONS TO-220AB CASE 221A-09 ISSUE AA

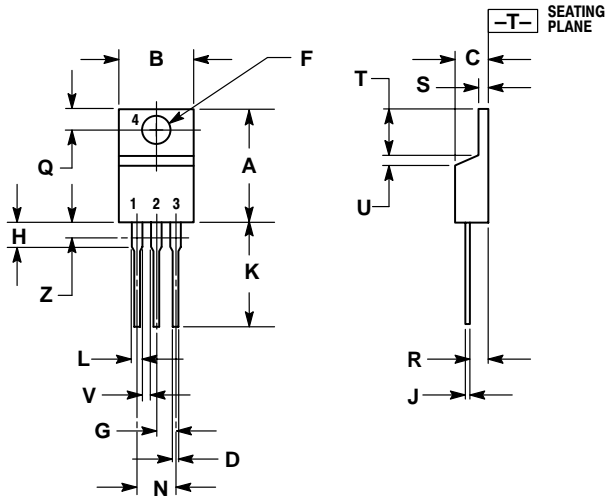

- NOTES:
1. DIMENSIONING AND TOLERANCING PER ANSI Y14.5M, 1982.
 2. CONTROLLING DIMENSION: INCH.
 3. DIMENSION Z DEFINES A ZONE WHERE ALL BODY AND LEAD IRREGULARITIES ARE ALLOWED.

DIM	INCHES		MILLIMETERS	
	MIN	MAX	MIN	MAX
A	0.570	0.620	14.48	15.75
B	0.380	0.405	9.66	10.28
C	0.160	0.190	4.07	4.82
D	0.025	0.035	0.64	0.88
F	0.142	0.147	3.61	3.73
G	0.095	0.105	2.42	2.66
H	0.110	0.155	2.80	3.93
J	0.018	0.025	0.46	0.64
K	0.500	0.562	12.70	14.27
L	0.045	0.060	1.15	1.52
N	0.190	0.210	4.83	5.33
Q	0.100	0.120	2.54	3.04
R	0.080	0.110	2.04	2.79
S	0.045	0.055	1.15	1.39
T	0.235	0.255	5.97	6.47
U	0.000	0.050	0.00	1.27
V	0.045	---	1.15	---
Z	---	0.080	---	2.04

CASE 221D-02 (ISOLATED TO-220 TYPE) UL RECOGNIZED: FILE #E69369 ISSUE D

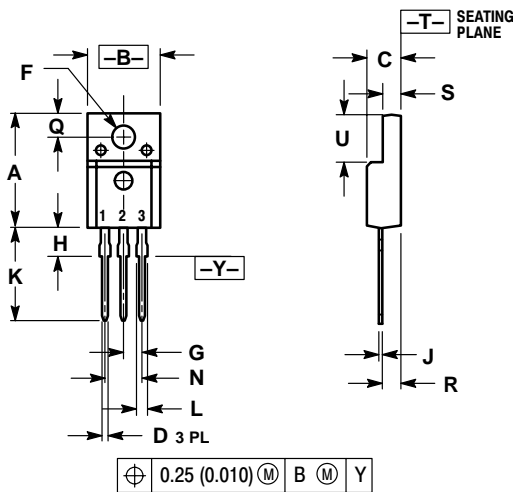

- NOTES:
1. DIMENSIONING AND TOLERANCING PER ANSI Y14.5M, 1982.
 2. CONTROLLING DIMENSION: INCH.

DIM	INCHES		MILLIMETERS	
	MIN	MAX	MIN	MAX
A	0.621	0.629	15.78	15.97
B	0.394	0.402	10.01	10.21
C	0.181	0.189	4.60	4.80
D	0.026	0.034	0.67	0.86
F	0.121	0.129	3.08	3.27
G	0.100 BSC		2.54 BSC	
H	0.123	0.129	3.13	3.27
J	0.018	0.025	0.46	0.64
K	0.500	0.562	12.70	14.27
L	0.045	0.060	1.14	1.52
N	0.200 BSC		5.08 BSC	
Q	0.126	0.134	3.21	3.40
R	0.107	0.111	2.72	2.81
S	0.096	0.104	2.44	2.64
U	0.259	0.267	6.58	6.78

- STYLE 1:
PIN 1. GATE
2. DRAIN
3. SOURCE

SWITCHMODE is a trademark of Semiconductor Components Industries, LLC.

ON Semiconductor and  are trademarks of Semiconductor Components Industries, LLC (SCILLC). SCILLC reserves the right to make changes without further notice to any products herein. SCILLC makes no warranty, representation or guarantee regarding the suitability of its products for any particular purpose, nor does SCILLC assume any liability arising out of the application or use of any product or circuit, and specifically disclaims any and all liability, including without limitation special, consequential or incidental damages. "Typical" parameters which may be provided in SCILLC data sheets and/or specifications can and do vary in different applications and actual performance may vary over time. All operating parameters, including "Typicals" must be validated for each customer application by customer's technical experts. SCILLC does not convey any license under its patent rights nor the rights of others. SCILLC products are not designed, intended, or authorized for use as components in systems intended for surgical implant into the body, or other applications intended to support or sustain life, or for any other application in which the failure of the SCILLC product could create a situation where personal injury or death may occur. Should Buyer purchase or use SCILLC products for any such unintended or unauthorized application, Buyer shall indemnify and hold SCILLC and its officers, employees, subsidiaries, affiliates, and distributors harmless against all claims, costs, damages, and expenses, and reasonable attorney fees arising out of, directly or indirectly, any claim of personal injury or death associated with such unintended or unauthorized use, even if such claim alleges that SCILLC was negligent regarding the design or manufacture of the part. SCILLC is an Equal Opportunity/Affirmative Action Employer.

PUBLICATION ORDERING INFORMATION

NORTH AMERICA Literature Fulfillment:

Literature Distribution Center for ON Semiconductor
P.O. Box 5163, Denver, Colorado 80217 USA
Phone: 303-675-2175 or 800-344-3860 Toll Free USA/Canada
Fax: 303-675-2176 or 800-344-3867 Toll Free USA/Canada
Email: ONlit@hibbertco.com
Fax Response Line: 303-675-2167 or 800-344-3810 Toll Free USA/Canada

N. American Technical Support: 800-282-9855 Toll Free USA/Canada

EUROPE: LDC for ON Semiconductor – European Support

German Phone: (+1) 303-308-7140 (Mon-Fri 2:30pm to 7:00pm CET)
Email: ONlit-german@hibbertco.com
French Phone: (+1) 303-308-7141 (Mon-Fri 2:00pm to 7:00pm CET)
Email: ONlit-french@hibbertco.com
English Phone: (+1) 303-308-7142 (Mon-Fri 12:00pm to 5:00pm GMT)
Email: ONlit@hibbertco.com

EUROPEAN TOLL-FREE ACCESS*: 00-800-4422-3781

*Available from Germany, France, Italy, UK, Ireland

CENTRAL/SOUTH AMERICA:

Spanish Phone: 303-308-7143 (Mon-Fri 8:00am to 5:00pm MST)
Email: ONlit-spanish@hibbertco.com
Toll-Free from Mexico: Dial 01-800-288-2872 for Access –
then Dial 866-297-9322

ASIA/PACIFIC: LDC for ON Semiconductor – Asia Support

Phone: 1-303-675-2121 (Tue-Fri 9:00am to 1:00pm, Hong Kong Time)
Toll Free from Hong Kong & Singapore:
001-800-4422-3781
Email: ONlit-asia@hibbertco.com

JAPAN: ON Semiconductor, Japan Customer Focus Center

4-32-1 Nishi-Gotanda, Shinagawa-ku, Tokyo, Japan 141-0031
Phone: 81-3-5740-2700
Email: r14525@onsemi.com

ON Semiconductor Website: <http://onsemi.com>

For additional information, please contact your local Sales Representative.