

NPN Silicon Power Darlington Transistors

The MJE5740 and MJE5742 Darlington transistors are designed for high-voltage power switching in inductive circuits. They are particularly suited for operation in applications such as:

- Small Engine Ignition
- Switching Regulators
- Inverters
- Solenoid and Relay Drivers
- Motor Controls

MAXIMUM RATINGS

Rating	Symbol	MJE5740	MJE5742	Unit
Collector–Emitter Voltage	$V_{CEO(sus)}$	300	400	Vdc
Collector–Emitter Voltage	V_{CEV}	600	800	Vdc
Emitter Base Voltage	V_{EB}	8		Vdc
Collector Current – Continuous	I_C	8		Adc
– Peak (1)	I_{CM}	16		
Base Current – Continuous	I_B	2.5		Adc
– Peak (1)	I_{BM}	5		
Total Power Dissipation @ $T_A = 25^\circ\text{C}$ Derate above 25°C	P_D	2		Watts
		16		mW/ $^\circ\text{C}$
Total Power Dissipation @ $T_C = 25^\circ\text{C}$ Derate above 25°C	P_D	80		Watts
		640		mW/ $^\circ\text{C}$
Operating and Storage Junction Temperature Range	T_J, T_{stg}	–65 to +150		$^\circ\text{C}$

(1) Pulse Test: Pulse Width = 5 ms, Duty Cycle = 10%.

THERMAL CHARACTERISTICS

Characteristic	Symbol	Max	Unit
Thermal Resistance, Junction to Case	$R_{\theta JC}$	1.56	$^\circ\text{C}/\text{W}$
Thermal Resistance, Junction to Ambient	$R_{\theta JA}$	62.5	$^\circ\text{C}/\text{W}$
Maximum Lead Temperature for Soldering Purposes: 1/8" from Case for 5 Seconds	T_L	275	$^\circ\text{C}$

MJE5740 MJE5742*

*ON Semiconductor Preferred Device

**POWER DARLINGTON
TRANSISTORS
8 AMPERES
300, 400 VOLTS
80 WATTS**

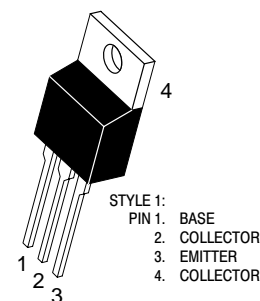
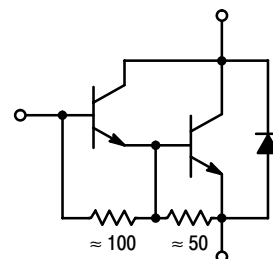

**CASE 221A-06
TO-220AB**

Preferred devices are ON Semiconductor recommended choices for future use and best overall value.

MJE5740 MJE5742

ELECTRICAL CHARACTERISTICS ($T_C = 25^\circ\text{C}$ unless otherwise noted)

Characteristic	Symbol	Min	Typ	Max	Unit
----------------	--------	-----	-----	-----	------

OFF CHARACTERISTICS (2)

Collector–Emitter Sustaining Voltage ($I_C = 50\text{ mA}$, $I_B = 0$)	MJE5740 MJE5742	$V_{CEO(sus)}$	300 400	– –	– –	Vdc
Collector Cutoff Current ($V_{CEV} = \text{Rated Value}$, $V_{BE(off)} = 1.5\text{ Vdc}$) ($V_{CEV} = \text{Rated Value}$, $V_{BE(off)} = 1.5\text{ Vdc}$, $T_C = 100^\circ\text{C}$)		I_{CEV}	– –	– –	1 5	mAdc
Emitter Cutoff Current ($V_{EB} = 8\text{ Vdc}$, $I_C = 0$)		I_{EBO}	–	–	75	mAdc

SECOND BREAKDOWN

Second Breakdown Collector Current with Base Forward Biased	$I_{S/b}$	See Figure 6			
Clamped Inductive SOA with Base Reverse Biased	RBSOA	See Figure 7			

Characteristic	Symbol	Min	Typ	Max	Unit
----------------	--------	-----	-----	-----	------

ON CHARACTERISTICS (3)

DC Current Gain ($I_C = 0.5\text{ Adc}$, $V_{CE} = 5\text{ Vdc}$) ($I_C = 4\text{ Adc}$, $V_{CE} = 5\text{ Vdc}$)	h_{FE}	50 200	100 400	– –	–
Collector–Emitter Saturation Voltage ($I_C = 4\text{ Adc}$, $I_B = 0.2\text{ Adc}$) ($I_C = 8\text{ Adc}$, $I_B = 0.4\text{ Adc}$) ($I_C = 4\text{ Adc}$, $I_B = 0.2\text{ Adc}$, $T_C = 100^\circ\text{C}$)	$V_{CE(sat)}$	– – –	– – –	2 3 2.2	Vdc
Base–Emitter Saturation Voltage ($I_C = 4\text{ Adc}$, $I_B = 0.2\text{ Adc}$) ($I_C = 8\text{ Adc}$, $I_B = 0.4\text{ Adc}$) ($I_C = 4\text{ Adc}$, $I_B = 0.2\text{ Adc}$, $T_C = 100^\circ\text{C}$)	$V_{BE(sat)}$	– – –	– – –	2.5 3.5 2.4	Vdc
Diode Forward Voltage (4) ($I_F = 5\text{ Adc}$)	V_f	–	–	2.5	Vdc

SWITCHING CHARACTERISTICS

Typical Resistive Load (Table 1)						
Delay Time	$(V_{CC} = 250\text{ Vdc}$, $I_{C(pk)} = 6\text{ A}$ $I_{B1} = I_{B2} = 0.25\text{ A}$, $t_p = 25\text{ }\mu\text{s}$, Duty Cycle $\leq 1\%$)	t_d	–	0.04	–	μs
Rise Time		t_r	–	0.5	–	μs
Storage Time		t_s	–	8	–	μs
Fall Time		t_f	–	2	–	μs
Inductive Load, Clamped (Table 1)						
Voltage Storage Time	$(I_{C(pk)} = 6\text{ A}$, $V_{CE(pk)} = 250\text{ Vdc}$ $I_{B1} = 0.06\text{ A}$, $V_{BE(off)} = 5\text{ Vdc}$)	t_{sv}	–	4	–	μs
Crossover Time		t_c	–	2	–	μs

(2) Pulse Test: Pulse Width = 300 μs , Duty Cycle = 2%.

(3) Pulse Test: Pulse Width 300 μs , Duty Cycle = 2%.

(4) The internal Collector–to–Emitter diode can eliminate the need for an external diode to clamp inductive loads. Tests have shown that the Forward Recovery Voltage (V_f) of this diode is comparable to that of typical fast recovery rectifiers.

(continued)

MJE5740 MJE5742

TYPICAL CHARACTERISTICS

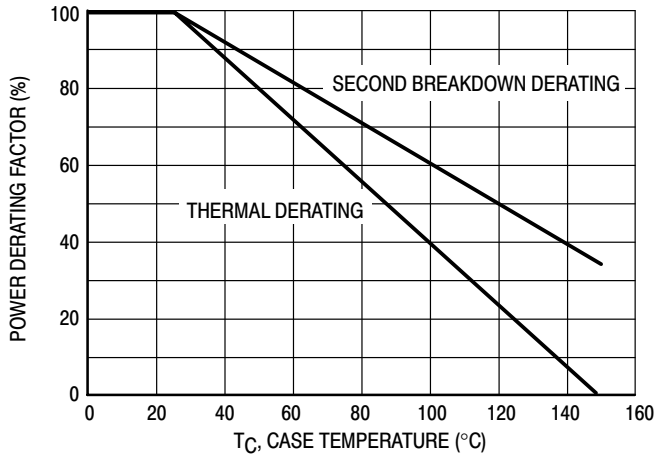

Figure 1. Power Derating

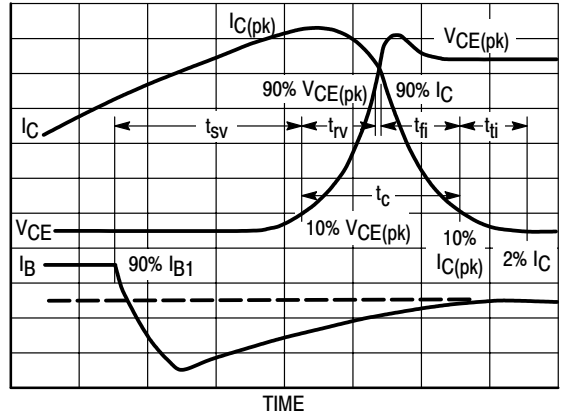

Figure 2. Inductive Switching Measurements

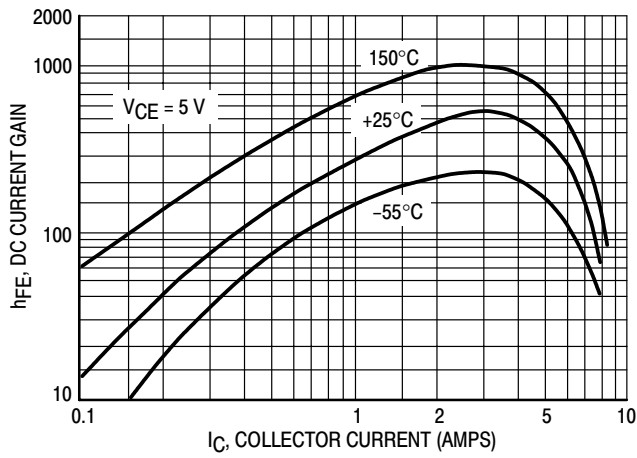

Figure 3. DC Current Gain

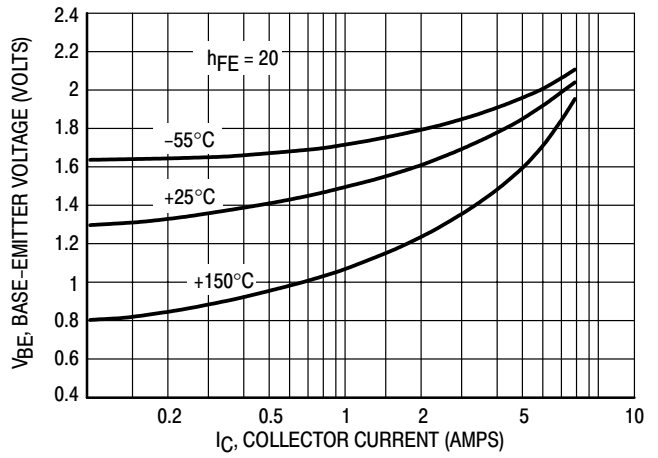

Figure 4. Base-Emitter Voltage

MJE5740 MJE5742

Table 1. Test Conditions for Dynamic Performance

REVERSE BIAS SAFE OPERATING AREA AND INDUCTIVE SWITCHING		RESISTIVE SWITCHING
TEST CIRCUITS	<p>DUTY CYCLE $\leq 10\%$ $t_r, t_f \leq 10$ ns</p> <p>NOTE: PW and V_{CC} Adjusted for Desired I_C R_B Adjusted for Desired I_{B1}</p>	
CIRCUIT VALUES	COIL DATA: FERROXCUBE CORE #6656 FULL BOBBIN (~16 TURNS) #16 GAP FOR 200 μ H/20 A $L_{coil} = 200 \mu$ H $V_{CC} = 30$ V $V_{CE(pk)} = 250$ Vdc $I_{C(pk)} = 6$ A	$V_{CC} = 250$ V $D1 = 1N5820$ OR EQUIV.
TEST WAVEFORMS	<p>OUTPUT WAVEFORMS</p> <p>t_1 ADJUSTED TO OBTAIN I_C</p> $t_1 \approx \frac{L_{coil} (I_{Cpk})}{V_{CC}}$ <p>TEST EQUIPMENT SCOPE-TEKTRONICS 475 OR EQUIVALENT</p> $t_2 \approx \frac{L_{coil} (I_{Cpk})}{V_{clamp}}$	<p>$t_r, t_f < 10$ ns DUTY CYCLE = 1% R_B AND R_C ADJUSTED FOR DESIRED I_B AND I_C</p>

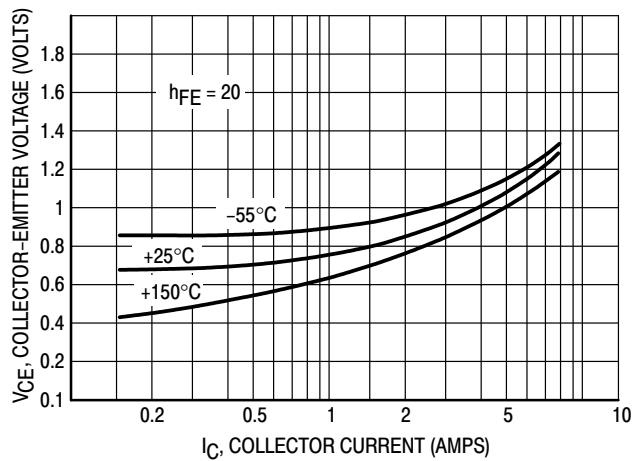

Figure 5. Inductive Switching Measurements

MJE5740 MJE5742

SAFE OPERATING AREA INFORMATION

FORWARD BIAS

There are two limitations on the power handling ability of a transistor: average junction temperature and second breakdown. Safe operating area curves indicate $I_C - V_{CE}$ limits of the transistor that must be observed for reliable operation; i.e., the transistor must not be subjected to greater dissipation than the curves indicate.

The data of Figure 6 is based on $T_C = 25^\circ\text{C}$; $T_{J(pk)}$ is variable depending on power level. Second breakdown pulse limits are valid for duty cycles to 10% but must be derated when $T_C \geq 25^\circ\text{C}$. Second breakdown limitations do not derate the same as thermal limitations. Allowable current at the voltages shown on Figure 6 may be found at any case temperature by using the appropriate curve on Figure 1.

The Safe Operating Area figures shown in Figures 6 and 7 are specified ratings for these devices under the test conditions shown.

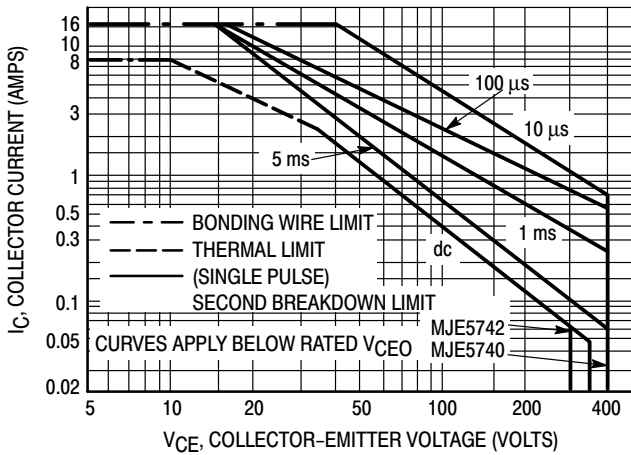

Figure 6. Forward Bias Safe Operating Area

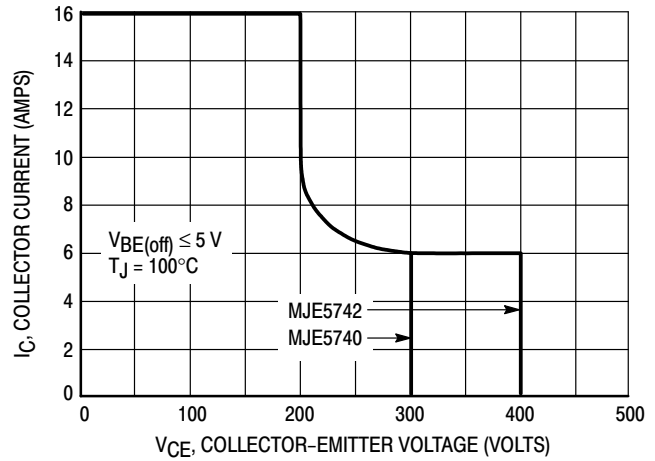

Figure 7. Reverse Bias Safe Operating Area

RESISTIVE SWITCHING PERFORMANCE

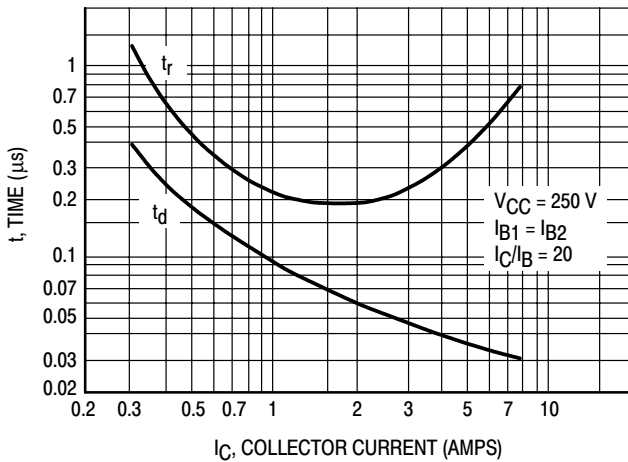

Figure 8. Turn-On Time

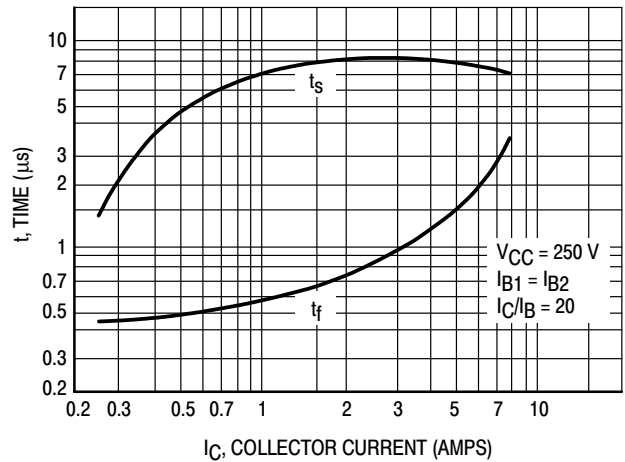
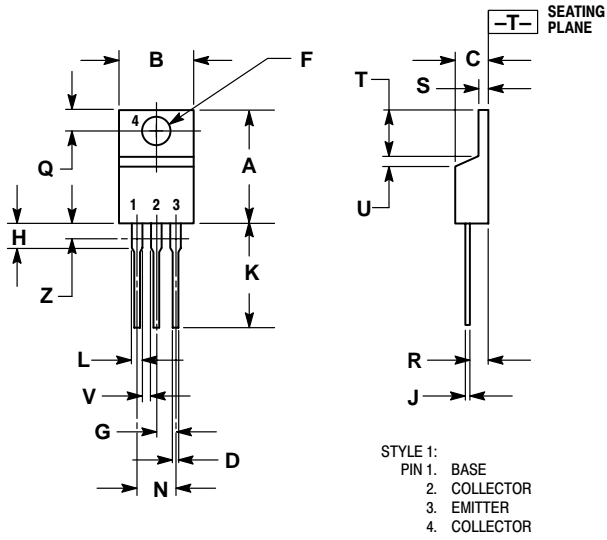

Figure 9. Turn-Off Time

MJE5740 MJE5742

PACKAGE DIMENSIONS

TO-220AA CASE 221A-09 ISSUE AA



- NOTES:
1. DIMENSIONING AND TOLERANCING PER ANSI Y14.5M, 1982.
 2. CONTROLLING DIMENSION: INCH.
 3. DIMENSION Z DEFINES A ZONE WHERE ALL BODY AND LEAD IRREGULARITIES ARE ALLOWED.

DIM	INCHES		MILLIMETERS	
	MIN	MAX	MIN	MAX
A	0.570	0.620	14.48	15.75
B	0.380	0.405	9.66	10.28
C	0.160	0.190	4.07	4.82
D	0.025	0.035	0.64	0.88
F	0.142	0.147	3.61	3.73
G	0.095	0.105	2.42	2.66
H	0.110	0.155	2.80	3.93
J	0.018	0.025	0.46	0.64
K	0.500	0.562	12.70	14.27
L	0.045	0.060	1.15	1.52
N	0.190	0.210	4.83	5.33
Q	0.100	0.120	2.54	3.04
R	0.080	0.110	2.04	2.79
S	0.045	0.055	1.15	1.39
T	0.235	0.255	5.97	6.47
U	0.000	0.050	0.00	1.27
V	0.045	---	1.15	---
Z	---	0.080	---	2.04

Notes

ON Semiconductor and  are registered trademarks of Semiconductor Components Industries, LLC (SCILLC). SCILLC reserves the right to make changes without further notice to any products herein. SCILLC makes no warranty, representation or guarantee regarding the suitability of its products for any particular purpose, nor does SCILLC assume any liability arising out of the application or use of any product or circuit, and specifically disclaims any and all liability, including without limitation special, consequential or incidental damages. "Typical" parameters which may be provided in SCILLC data sheets and/or specifications can and do vary in different applications and actual performance may vary over time. All operating parameters, including "Typicals" must be validated for each customer application by customer's technical experts. SCILLC does not convey any license under its patent rights nor the rights of others. SCILLC products are not designed, intended, or authorized for use as components in systems intended for surgical implant into the body, or other applications intended to support or sustain life, or for any other application in which the failure of the SCILLC product could create a situation where personal injury or death may occur. Should Buyer purchase or use SCILLC products for any such unintended or unauthorized application, Buyer shall indemnify and hold SCILLC and its officers, employees, subsidiaries, affiliates, and distributors harmless against all claims, costs, damages, and expenses, and reasonable attorney fees arising out of, directly or indirectly, any claim of personal injury or death associated with such unintended or unauthorized use, even if such claim alleges that SCILLC was negligent regarding the design or manufacture of the part. SCILLC is an Equal Opportunity/Affirmative Action Employer.

PUBLICATION ORDERING INFORMATION

Literature Fulfillment:

Literature Distribution Center for ON Semiconductor
P.O. Box 5163, Denver, Colorado 80217 USA
Phone: 303-675-2175 or 800-344-3860 Toll Free USA/Canada
Fax: 303-675-2176 or 800-344-3867 Toll Free USA/Canada
Email: ONlit@hibbertco.com

N. American Technical Support: 800-282-9855 Toll Free USA/Canada

JAPAN: ON Semiconductor, Japan Customer Focus Center
4-32-1 Nishi-Gotanda, Shinagawa-ku, Tokyo, Japan 141-0031
Phone: 81-3-5740-2700
Email: r14525@onsemi.com

ON Semiconductor Website: <http://onsemi.com>

For additional information, please contact your local Sales Representative.