

FEATURES

- ▶ Highest Power Density
- ▶ 1" x 1" x 0.4" Shielded Metal Package
- ▶ Wide 2:1 Input Range
- ▶ Excellent Efficiency up to 90%
- ▶ Operating Temp. Range -40°C to +80°C
- ▶ Optional Heatsink
- ▶ I/O-isolation Voltage 1500VDC
- ▶ Remote On/Off Control
- ▶ Over Load Protection
- ▶ CSA/UL/IEC/EN 60950-1 (Approval pending)
- ▶ 3 Year Product Warranty



PRODUCT OVERVIEW

The MINMAX MJW25 series is the latest range of a new generation of high performance dc-dc converter modules with very high power density. The product offers fully 25W in a shielded metal package with dimensions of just 1.0"x1.0"x0.4". All models provide wide 2:1 input range and tightly regulated output voltage. By state-of-the-art circuit topology a very high efficiency up to 90% could be achieved allowing an operating temperature range of -40°C to +80°C (with derating).

These converters are qualified for demanding applications in battery operated equipment, instrumentation, data communication, industrial and many other space critical applications.

Model Selection Guide

Model Number	Input Voltage (Range)	Output Voltage	Output Current	Input Current		Reflected Ripple Current	Over Voltage Protection	Max. capacitive Load	Efficiency (typ.)
			Max.	@Max. Load	@No Load				@Max. Load
	VDC	VDC	mA	mA(typ.)	mA(typ.)	mA (typ.)	VDC	μF	%
MJW25-12S033	12 (9 ~ 18)	3.3	6000	1900	75	80	3.9	10300	87
MJW25-12S05		5	5000	2340	85		6.2	6800	89
MJW25-12S12		12	2090	2350	80		15	1200	89
MJW25-12S15		15	1670	2350	80		18	750	89
MJW25-12D12		±12	±1040	2340	75		±15	680#	89
MJW25-12D15		±15	±840	2360	75		±18	380#	89
MJW25-24S033	24 (18 ~ 36)	3.3	6000	940	55	50	3.9	10300	88
MJW25-24S05		5	5000	1160	60		6.2	6800	90
MJW25-24S12		12	2090	1160	55		15	1200	90
MJW25-24S15		15	1670	1160	55		18	750	90
MJW25-24D12		±12	±1040	1170	50		±15	680#	89
MJW25-24D15		±15	±840	1180	50		±18	380#	89
MJW25-48S033	48 (36 ~ 75)	3.3	6000	470	35	30	3.9	10300	88
MJW25-48S05		5	5000	580	40		6.2	6800	90
MJW25-48S12		12	2090	580	35		15	1200	90
MJW25-48S15		15	1670	580	35		18	750	90
MJW25-48D12		±12	±1040	585	40		±15	680#	89
MJW25-48D15		±15	±840	590	40		±18	380#	89

For each output

Input Specifications

Parameter	Model	Min.	Typ.	Max.	Unit	
Input Surge Voltage (100ms max.)	12V Input Models	-0.7	---	25	VDC	
	24V Input Models	-0.7	---	50		
	48V Input Models	-0.7	---	100		
Start-Up Threshold Voltage	12V Input Models	---	---	9	VDC	
	24V Input Models	---	---	18		
	48V Input Models	---	---	36		
Input Polarity Protection	None					
Start Up Time	Power Up	Nominal Vin and Constant Resistive Load			30	ms
	Remote On/Off				30	ms
Internal Filter Type	All Models	LC Filter (for EN55022, Class A or Class B compliance see page 9)				
Short Circuit Current	Hiccup Mode, 0.7Hz typ.					

Output Specifications

Parameter	Conditions	Min.	Typ.	Max.	Unit	
Output Voltage Setting Accuracy	At 50% Load and Nominal Vin	---	---	±1.0	%Vnom.	
Output Voltage Balance	Dual Output, Balanced Loads	---	---	±2.0	%	
Line Regulation	Vin=Min. to Max.	---	---	±0.2	%	
Load Regulation	No Load to Full Load	Single Output	---	---	±0.2	%
		Dual Output	---	---	±1.0	%
Cross Regulation (Dual)	Asymmetrical load 25% / 100% FL	---	---	±5.0	%	
Min.Load	No minimum Load Requirement					
Ripple & Noise (20MHz)	3.3V & 5V Models	---	100	---	mV _{p-p}	
Ripple & Noise (20MHz)	12V , 15V & Dual Models	---	150	---	mV _{p-p}	
Transient Recovery Time	25% Load Step Change	---	250	---	µsec	
Temperature Coefficient		---	---	±0.02	%/°C	
Over Load Protection	Current Limitation at 150% typ. of Iout max., Hiccup					
Short Circuit Protection	Hiccup Automatic Recovery					
Over Voltage Protection	For Shutdown Voltage see Model Selection Guide					

General Specifications

Parameter	Conditions	Min.	Typ.	Max.	Unit
I/O Isolation Voltage (rated)	60 Seconds	1500	---	---	VDC
I/O Isolation Resistance	500 VDC	1000	---	---	MΩ
I/O Isolation Capacitance	100KHz, 1V	---	---	2000	pF
Switching Frequency		---	285	---	KHz
MTBF(calculated)	MIL-HDBK-217F@25°C, Ground Benign	372,000	---	---	Hours
Safety Approvals(pending)	UL/cUL 60950-1 recognition(CSA certificate), IEC/EN 60950-1(CB-scheme)				

Input Fuse

12V Input Models	24V Input Models	48V Input Models
500mA Slow-Blow Type	2500mA Slow-Blow Type	1250mA Slow-Blow Type

Remote On/Off Control

Parameter	Conditions	Min.	Typ.	Max.	Unit
Converter On	3.5V ~ 12V or Open Circuit				
Converter Off	0V ~ 1.2V or Short Circuit				
Control Input Current (on)	Vctrl = 5.0V	---	---	0.5	mA
Control Input Current (off)	Vctrl = 0V	---	---	-0.5	mA
Control Common	Referenced to Negative Input				
Standby Input Current	Supply Off & Nominal Vin	---	3	---	mA

Output Voltage Trim

Parameter	Conditions	Min.	Typ.	Max.	Unit
Trim Up / Down Range	% of Nominal Output Voltage	±10	---	---	%

Environmental Specifications

Parameter	Model	Min.	Max.		Unit
			without Heatsink	with Heatsink	
Operating Ambient Temperature Range (Natural Convection, see Derating)	MJW25-24S033, MJW25-48S033	-40	57	65	°C
	MJW25-24S05, MJW25-24S12		56	64	
	MJW25-24S15, MJW25-48S05				
	MJW25-48S12, MJW25-48S15				
	MJW25-12S033		50	61	
	MJW25-12S05, MJW25-12S12, MJW25-12S15				
	MJW25-12D12, MJW25-12D15				
	MJW25-24D12, MJW25-24D15				
Thermal Impedance	MJW25-48D12, MJW25-48D15	17.6	---	---	°C/W
	Natural Convection without Heatsink	14.8	---	---	°C/W
	Natural Convection with Heatsink	13.6	---	---	°C/W
	100LFM Convection without Heatsink	8.5	---	---	°C/W
	100LFM Convection with Heatsink	11.8	---	---	°C/W
	200LFM Convection without Heatsink	6.5	---	---	°C/W
	200LFM Convection with Heatsink	8.8	---	---	°C/W
	400LFM Convection without Heatsink	4.3	---	---	°C/W
400LFM Convection with Heatsink	---	+105	---	°C	
Case Temperature	---	-50	+125	---	°C
Storage Temperature Range	---	---	95	---	% rel. H
Humidity (non condensing)	Free-Air convection				
Cooling	Six-Sided Shielded, Metal Case				
RFI	---	---	260	---	°C
Lead Temperature (1.5mm from case for 10Sec.)	---	---	---	---	°C

EMC Specifications

Parameter	Standards & Level	Performance
EMI	EN55022	Class A/Class B (See Page 9)
ESD	EN61000-4-2 air ± 8KV, Contact ± 6KV	Perf. Criteria A
Radiated immunity	EN61000-4-3 10V/m	Perf. Criteria A
Fast transient (See Note 7)	EN61000-4-4 ±2KV	Perf. Criteria A
Surge (See Note 7)	EN61000-4-5 ±1KV	Perf. Criteria A
Conducted immunity	EN61000-4-6 10V/m	Perf. Criteria A

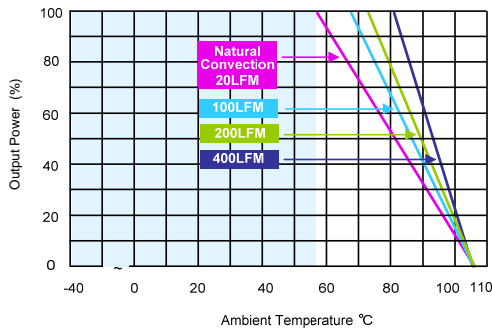
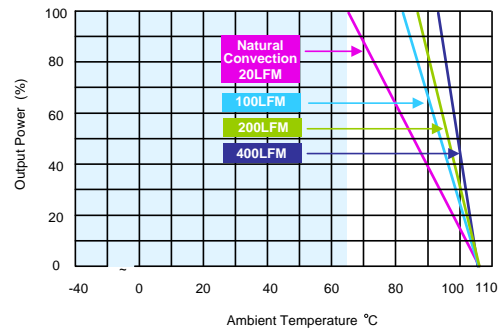
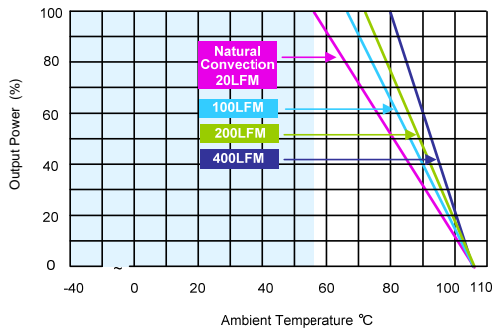
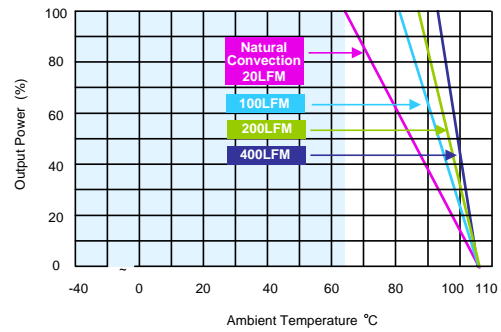
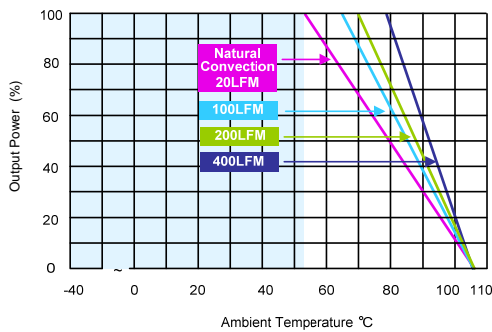
Power Derating Curve

 MJW25-24S033, MJW25-48S033
Derating Curve without Heatsink

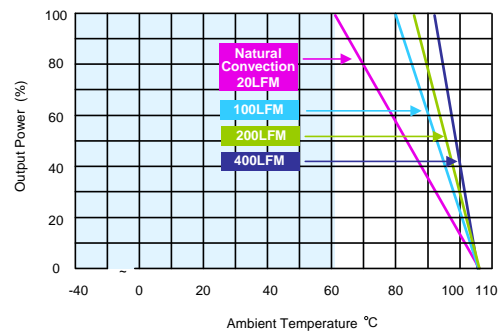
 MJW25-24S033, MJW25-48S033
Derating Curve with Heatsink

 MJW25-24S05, MJW25-24S12, MJW25-24S15, MJW25-48S05
MJW25-48S12, MJW25-48S15 Derating Curve without Heatsink

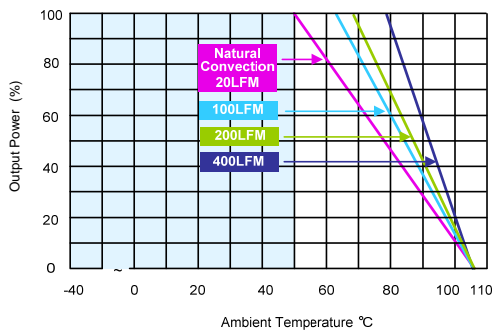
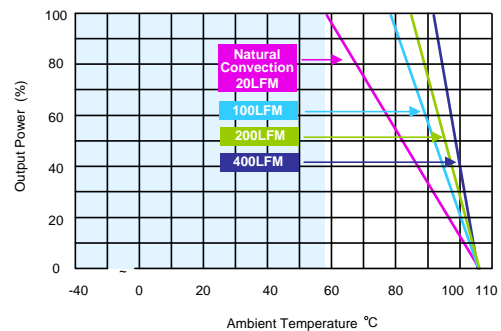
 MJW25-24S05, MJW25-24S12, MJW25-24S15, MJW25-48S05
MJW25-48S12, MJW25-48S15 Derating Curve with Heatsink

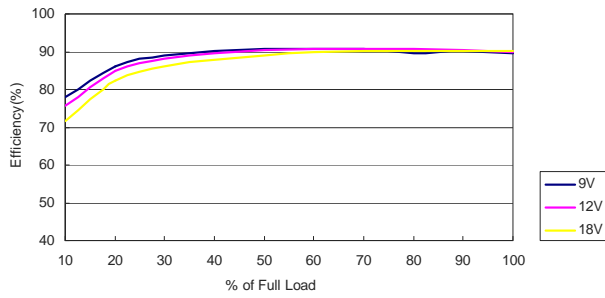
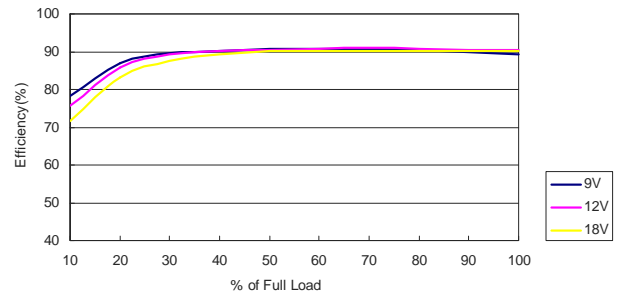
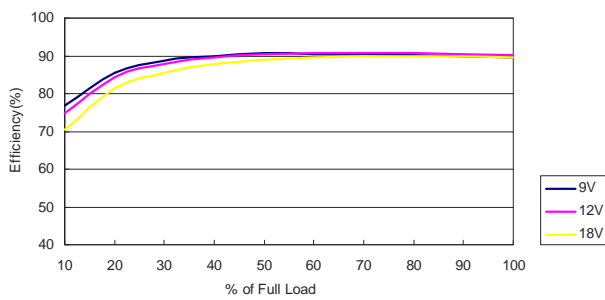
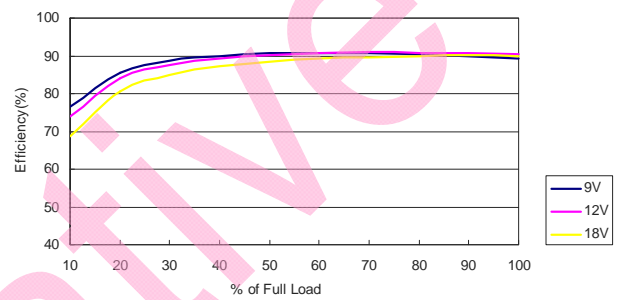
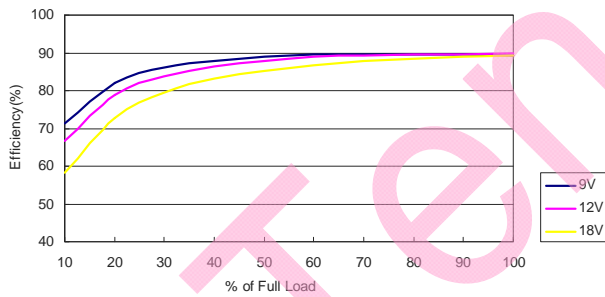
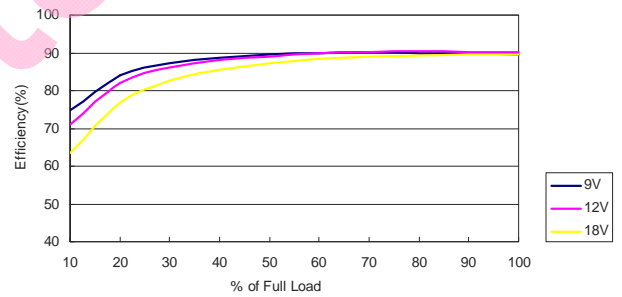
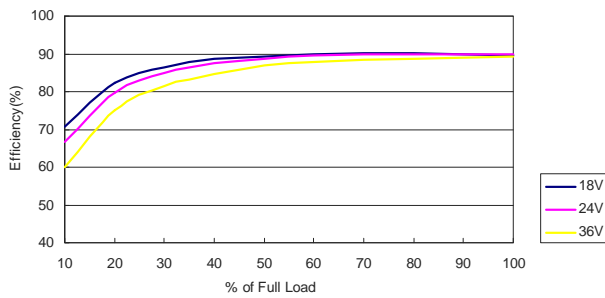
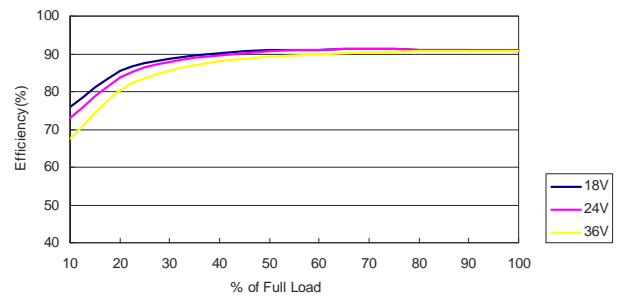
MJW25-12S033 Derating Curve without Heatsink



MJW25-12S033 Derating Curve with Heatsink

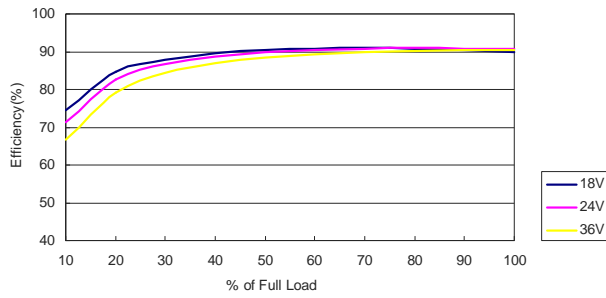
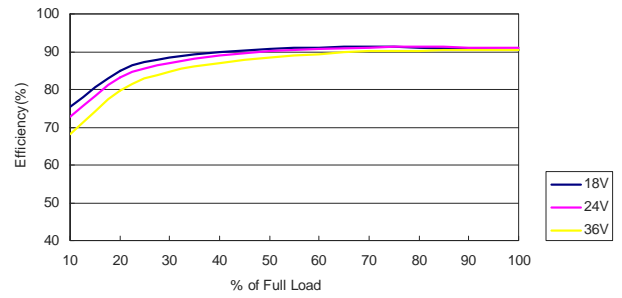
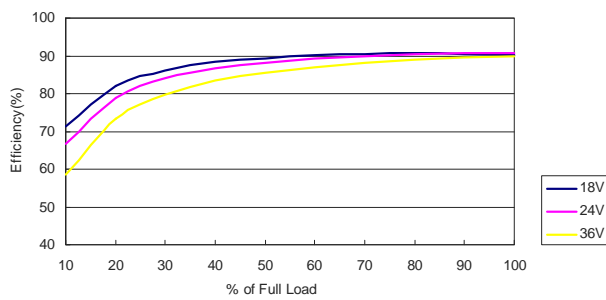
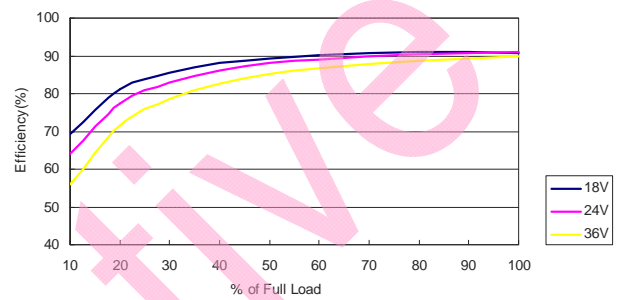
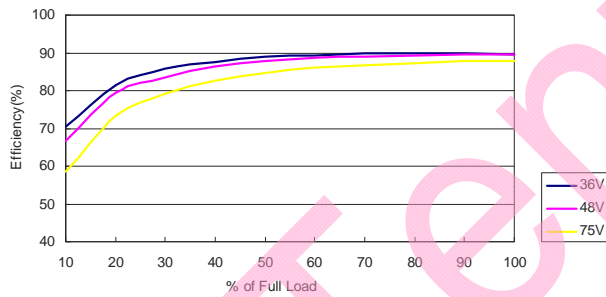
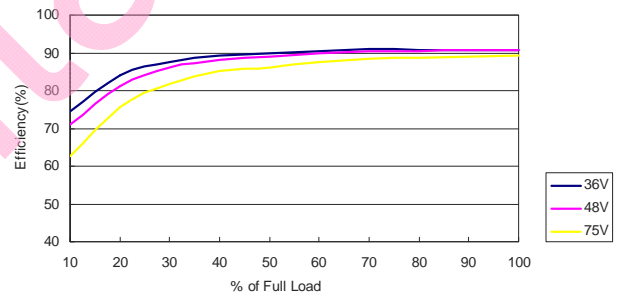
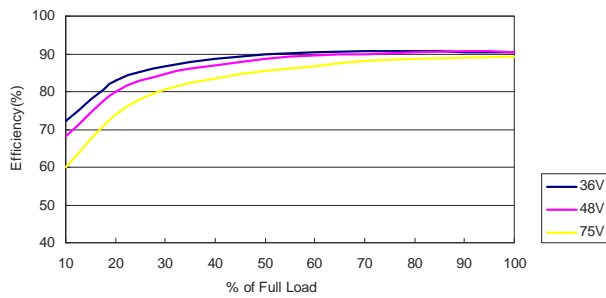
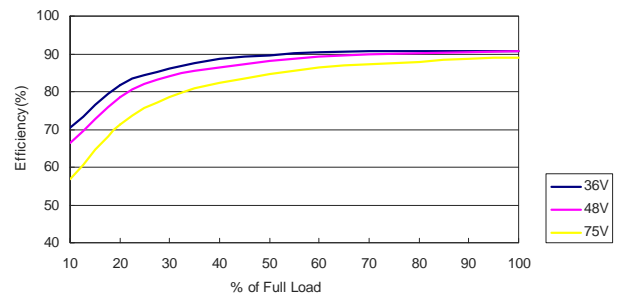

 MJW25-12S05, MJW25-12S12, MJW25-12S15, MJW25-12D12
MJW25-12D15, MJW25-24D12, MJW25-24D15, MJW25-48D12, MJW25-48D15
Derating Curve without Heatsink

 MJW25-12S05, MJW25-12S12, MJW25-12S15, MJW25-12D12
MJW25-12D15, MJW25-24D12, MJW25-24D15, MJW25-48D12, MJW25-48D15
Derating Curve with Heatsink

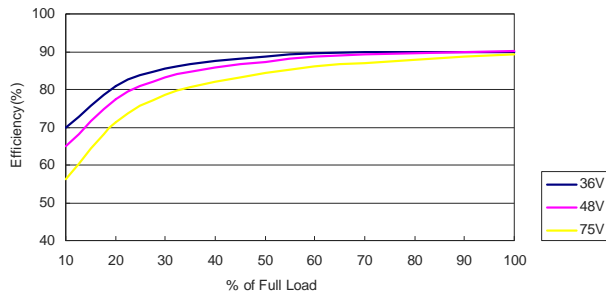
Efficiency Curve @25°C

MJW25-12S033 Efficiency vs Load Current

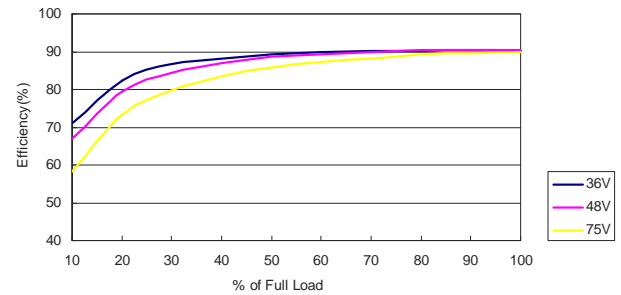
MJW25-12S05 Efficiency vs Load Current

MJW25-12S12 Efficiency vs Load Current

MJW25-12S15 Efficiency vs Load Current

MJW25-12D12 Efficiency vs Load Current

MJW25-12D15 Efficiency vs Load Current

MJW25-24S033 Efficiency vs Load Current

MJW25-24S05 Efficiency vs Load Current

Efficiency Curve @25°C

MJW25-24S12 Efficiency vs Load Current

MJW25-24S15 Efficiency vs Load Current

MJW25-24D12 Efficiency vs Load Current

MJW25-24D15 Efficiency vs Load Current

MJW25-48S033 Efficiency vs Load Current

MJW25-48S05 Efficiency vs Load Current

MJW25-48S12 Efficiency vs Load Current

MJW25-48S15 Efficiency vs Load Current

Efficiency Curve @25°C

MJW25-48D12 Efficiency vs Load Current



MJW25-48D15 Efficiency vs Load Current

Notes

- 1 Specifications typical at $T_a=+25^{\circ}\text{C}$, resistive load, nominal input voltage, rated output current unless otherwise noted.
- 2 Transient recovery time is measured to within 1% error band for a step change in output load of 75% to 100%.
- 3 Ripple & Noise measurement bandwidth is 20 MHz, measured with a $1\mu\text{F}$ MLCC and a $10\mu\text{F}$ Tantalum Capacitor.
- 4 All DC/DC converters should be externally fused at the front end for protection.
- 5 Other input and output voltage may be available, please contact factory.
- 6 To order the converter with heatsink, please add a **suffix -HS** (e.g. MJW25-24S05-HS) to order code.
- 7 The MJW25 series can meet EN61000-4-4 & EN61000-4-5 by adding a capacitor across the input pins. Suggested capacitor: CHEMI-CON KY 220 μF /100V.
- 8 That "natural convection" is about 20LFM but is not equal to still air (0 LFM).
- 9 Specifications are subject to change without notice.

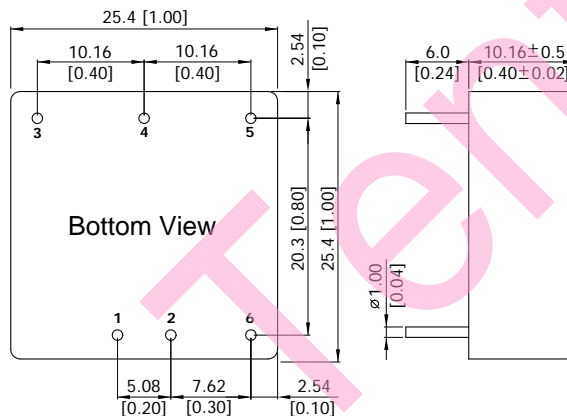
Package Specifications
Mechanical Dimensions

Pin Connections

Pin	Single Output	Dual Output
1	+Vin	+Vin
2	-Vin	-Vin
3	+Vout	+Vout
4	Trim	Common
5	-Vout	-Vout
6	Remote On/Off	Remote On/Off

- ▶ All dimensions in mm (inches)
- ▶ Tolerance: $X.X \pm 0.25$ ($X.XX \pm 0.01$)
 $X.XX \pm 0.13$ ($X.XXX \pm 0.005$)
- ▶ Pin diameter $\varnothing 1.0 \pm 0.05$ (0.04 ± 0.002)

Physical Characteristics

Case Size	: 25.4x25.4x10.16mm (1.0x1.0x0.4 inches)
Case Material	: Aluminium Alloy, Black Anodized Coating
Base Material	: FR4 PCB (flammability to UL 94V-0 rated)
Pin Material	: Copper Alloy with Gold Plate Over Nickel Subplate
Weight	: 16.5g

Heatsink (Option –HS)

Mechanical Dimensions

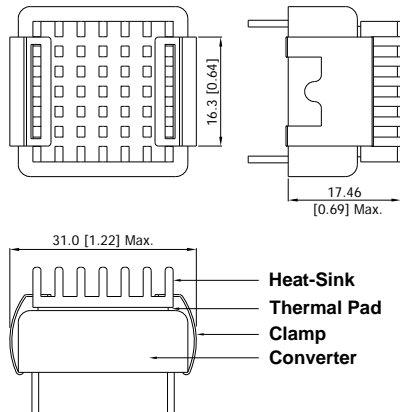

Heatsink Material: Aluminum
 Finish: Anodic treatment (black)
 Weight: 2g

► The advantages of adding a heatsink are:

- 1.To help heat dissipation and increase the stability and reliability of DC/DC converters at high operating temperature atmosphere.
- 2.To upgrade the operating temperature of DC/DC converters, please refer to Derating Curve.

External Output Trimming

Output can be externally trimmed by using the method shown below

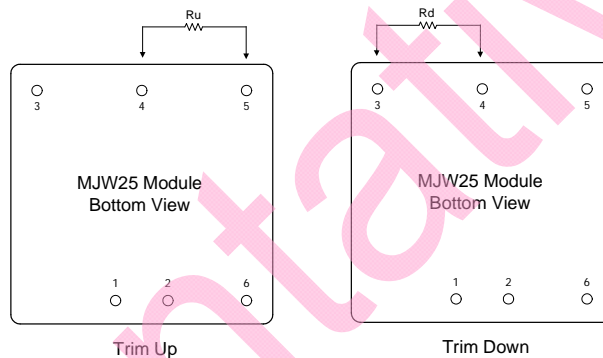

MJW25-XXS033 Trim Table

Trim down	1	2	3	4	5	6	7	8	9	10	%
Vout=	Vox0.99	Vox0.98	Vox0.97	Vox0.96	Vox0.95	Vox0.94	Vox0.93	Vox0.92	Vox0.91	Vox0.90	Volts
Rd=	63.59	30.28	18.19	11.95	8.13	5.56	3.70	2.31	1.21	0.34	KOhms
Trim up	1	2	3	4	5	6	7	8	9	10	%
Vout=	Vox1.01	Vox1.02	Vox1.03	Vox1.04	Vox1.05	Vox1.06	Vox1.07	Vox1.08	Vox1.09	Vox1.10	Volts
Ru=	70.50	29.28	16.87	10.90	7.38	5.06	3.42	2.20	1.25	0.49	KOhms

MJW25-XXS05 Trim Table

Trim down	1	2	3	4	5	6	7	8	9	10	%
Vout=	Vox0.99	Vox0.98	Vox0.97	Vox0.96	Vox0.95	Vox0.94	Vox0.93	Vox0.92	Vox0.91	Vox0.90	Volts
Rd=	45.53	20.61	12.31	8.15	5.66	4.00	2.81	1.92	1.23	0.68	KOhms
Trim up	1	2	3	4	5	6	7	8	9	10	%
Vout=	Vox1.01	Vox1.02	Vox1.03	Vox1.04	Vox1.05	Vox1.06	Vox1.07	Vox1.08	Vox1.09	Vox1.10	Volts
Ru=	36.57	16.58	9.92	6.59	4.59	3.25	2.30	1.59	1.03	0.59	KOhms

MJW25-XXS12 Trim Table

Trim down	1	2	3	4	5	6	7	8	9	10	%
Vout=	Vox0.99	Vox0.98	Vox0.97	Vox0.96	Vox0.95	Vox0.94	Vox0.93	Vox0.92	Vox0.91	Vox0.90	Volts
Rd=	394.50	179.74	106.08	68.86	46.39	31.36	20.60	12.51	6.21	1.17	KOhms
Trim up	1	2	3	4	5	6	7	8	9	10	%
Vout=	Vox1.01	Vox1.02	Vox1.03	Vox1.04	Vox1.05	Vox1.06	Vox1.07	Vox1.08	Vox1.09	Vox1.10	Volts
Ru=	368.92	161.92	94.97	61.86	42.12	29.00	19.66	12.66	7.23	2.89	KOhms

MJW25-XXS15 Trim Table

Trim down	1	2	3	4	5	6	7	8	9	10	%
Vout=	Vox0.99	Vox0.98	Vox0.97	Vox0.96	Vox0.95	Vox0.94	Vox0.93	Vox0.92	Vox0.91	Vox0.90	Volts
Rd=	572.67	248.63	145.60	94.97	64.87	44.92	30.72	20.10	11.86	5.28	KOhms
Trim up	1	2	3	4	5	6	7	8	9	10	%
Vout=	Vox1.01	Vox1.02	Vox1.03	Vox1.04	Vox1.05	Vox1.06	Vox1.07	Vox1.08	Vox1.09	Vox1.10	Volts
Ru=	392.98	182.12	108.73	71.43	48.85	33.71	22.86	14.69	8.33	3.23	KOhms

EMI-Filter to meet EN 55022, class A, class B; FCC part 15, level A

Conducted and radiated emissions EN55022 Class A, Class B

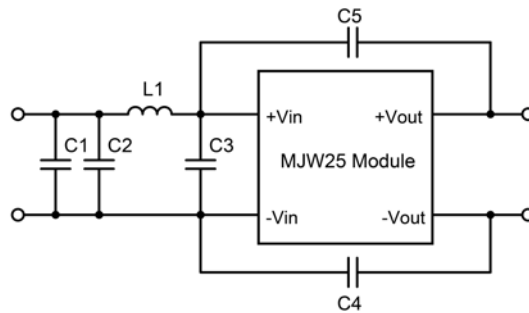

Class	Model	C1	C2	C3	C4&C5	L1
Class A	MJW25-12XXX	None	3.3 μ F/25V 1210 MLCC	None	None	1 μ H
	MJW25-24XXX	None	3.3 μ F/50V 1210 MLCC	None	None	2.2 μ H
	MJW25-48XXX	None	3.3 μ F/100V 1210 MLCC	None	None	4.7 μ H
Class B	MJW25-12XXX	3.3 μ F/25V 1210 MLCC	3.3 μ F/25V 1210 MLCC	3.3 μ F/25V 1210 MLCC	1800 pF/2KV 1206 MLCC	1 μ H
	MJW25-24XXX	3.3 μ F/50V 1210 MLCC	3.3 μ F/50V 1210 MLCC	3.3 μ F/50V 1210 MLCC	1800 pF/2KV 1206 MLCC	2.2 μ H
	MJW25-48XXX	3.3 μ F/100V 1210 MLCC	3.3 μ F/100V 1210 MLCC	3.3 μ F/100V 1210 MLCC	1800 pF/2KV 1206 MLCC	4.7 μ H

Test Setup

Input Reflected-Ripple Current Test Setup

Input reflected-ripple current is measured with an inductor L_{in} (4.7 μ H) and C_{in} (220 μ F, ESR < 1.0 Ω at 100 KHz) to simulate source impedance. Capacitor C_{in} , offsets possible battery impedance. Current ripple is measured at the input terminals of the module, measurement bandwidth is 0-500 KHz.

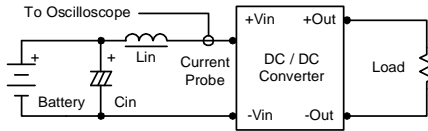

Peak-to-Peak Output Noise Measurement Test

Use a 1 μ F ceramic capacitor and a 10 μ F tantalum capacitor. Scope measurement should be made by using a BNC socket, measurement bandwidth is 0-20 MHz. Position the load between 50 mm and 75 mm from the DC/DC Converter.

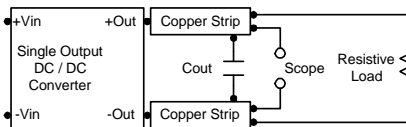

Technical Notes

Remote On/Off

Positive logic remote on/off turns the module on during a logic high voltage on the remote on/off pin, and off during a logic low. To turn the power module on and off, the user must supply a switch to control the voltage between the on/off terminal and the -Vin terminal. The switch can be an open collector or equivalent. A logic low is 0V to 1.2V. A logic high is 3.5V to 12V. The maximum sink current at the on/off terminal (Pin 6) during a logic low is -500 μ A. The maximum allowable leakage current of a switch connected to the on/off terminal (Pin 6) at logic high (3.5V to 12V) is 10mA.

Overcurrent Protection

To provide hiccup mode protection in a fault (output overload) condition, the unit is equipped with internal current limiting circuitry and can endure overload for an unlimited duration.

Overvoltage Protection

The output overvoltage clamp consists of control circuitry, which is independent of the primary regulation loop, that monitors the voltage on the output terminals. The control loop of the clamp has a higher voltage set point than the primary loop. This provides a redundant voltage control that reduces the risk of output overvoltage. The OVP level can be found in the output data.

Input Source Impedance

The power module should be connected to a low ac-impedance input source. Highly inductive source impedances can affect the stability of the power module. In applications where power is supplied over long lines and output loading is high, it may be necessary to use a capacitor at the input to ensure startup. Capacitor mounted close to the power module helps ensure stability of the unit, it is recommended to use a good quality low Equivalent Series Resistance (ESR < 1.0 Ω at 100 KHz) capacitor of a 10 μ F for the 24V and 48V devices.

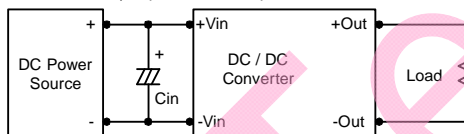

Output Ripple Reduction

A good quality low ESR capacitor placed as close as practicable across the load will give the best ripple and noise performance. To reduce output ripple, it is recommended to use 4.7 μ F capacitors at the output.

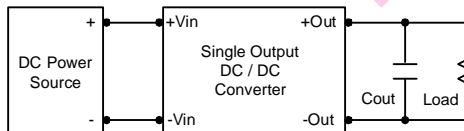

Maximum Capacitive Load

The MJW25 series has limitation of maximum connected capacitance at the output. The power module may be operated in current limiting mode during start-up, affecting the ramp-up and the startup time. The maximum capacitance can be found in the data sheet.

Thermal Considerations

Many conditions affect the thermal performance of the power module, such as orientation, airflow over the module and board spacing. To avoid exceeding the maximum temperature rating of the components inside the power module, the case temperature must be kept below 105 $^{\circ}$ C. The derating curves are determined from measurements obtained in a test setup.

