

FEATURES

- ▶ Highest Power Density
- ▶ 1" x 1" x 0.4" Shielded Metal Package
- ▶ Wide 2:1 Input Range
- ▶ Excellent Efficiency up to 90%
- ▶ Operating Temp. Range -40°C to +80°C
- ▶ Optional Heatsink
- ▶ I/O-isolation Voltage 1500VDC
- ▶ Remote On/Off Control
- ▶ Over Load Protection
- ▶ CSA/UL/IEC/EN 60950-1 (Approval pending)
- ▶ 3 Year Product Warranty



PRODUCT OVERVIEW

The MJW25 series is the latest range of a new generation of high performance dc-dc converter modules with very high power density. The product offers fully 25W in a shielded metal package with dimensions of just 1.0"x1.0"x0.4". All models provide wide 2:1 input range and tightly regulated output voltage. By state-of-the-art circuit topology a very high efficiency up to 90% could be achieved allowing an operating temperature range of -40°C to +80°C (with derating). These converters are qualified for demanding applications in battery operated equipment, instrumentation, data communication, industrial and many other space critical applications.

Model Selection Guide

| Model Number | Input Voltage (Range) | Output Voltage | Output Current | Input Current | | Reflected Ripple Current | Over Voltage Protection | Max. capacitive Load | Efficiency (typ.) |
|--------------|-----------------------|----------------|----------------|---------------|----------|--------------------------|-------------------------|----------------------|-------------------|
| | | | Max. | @Max. Load | @No Load | | | | @Max. Load |
| | VDC | VDC | mA | mA(typ.) | mA(typ.) | mA (typ.) | VDC | µF | % |
| MJW25-12S033 | 12 (9 ~ 18) | 3.3 | 6000 | 1900 | 75 | 80 | 3.9 | 10300 | 87 |
| MJW25-12S05 | | 5 | 5000 | 2340 | 85 | | 6.2 | 6800 | 89 |
| MJW25-12S12 | | 12 | 2090 | 2350 | 80 | | 15 | 1200 | 89 |
| MJW25-12S15 | | 15 | 1670 | 2350 | 80 | | 18 | 750 | 89 |
| MJW25-12D12 | | ±12 | ±1040 | 2340 | 75 | | ±15 | 680# | 89 |
| MJW25-12D15 | | ±15 | ±840 | 2360 | 75 | | ±18 | 380# | 89 |
| MJW25-24S033 | 24 (18 ~ 36) | 3.3 | 6000 | 940 | 55 | 50 | 3.9 | 10300 | 88 |
| MJW25-24S05 | | 5 | 5000 | 1160 | 60 | | 6.2 | 6800 | 90 |
| MJW25-24S12 | | 12 | 2090 | 1160 | 55 | | 15 | 1200 | 90 |
| MJW25-24S15 | | 15 | 1670 | 1160 | 55 | | 18 | 750 | 90 |
| MJW25-24D12 | | ±12 | ±1040 | 1170 | 50 | | ±15 | 680# | 89 |
| MJW25-24D15 | | ±15 | ±840 | 1180 | 50 | | ±18 | 380# | 89 |
| MJW25-48S033 | 48 (36 ~ 75) | 3.3 | 6000 | 470 | 35 | 30 | 3.9 | 10300 | 88 |
| MJW25-48S05 | | 5 | 5000 | 580 | 40 | | 6.2 | 6800 | 90 |
| MJW25-48S12 | | 12 | 2090 | 580 | 35 | | 15 | 1200 | 90 |
| MJW25-48S15 | | 15 | 1670 | 580 | 35 | | 18 | 750 | 90 |
| MJW25-48D12 | | ±12 | ±1040 | 585 | 40 | | ±15 | 680# | 89 |
| MJW25-48D15 | | ±15 | ±840 | 590 | 40 | | ±18 | 380# | 89 |

For each output



| Input Specifications | | | | | | |
|----------------------------------|-------------------------|---|------|------|------|----|
| Parameter | Model | Min. | Typ. | Max. | Unit | |
| Input Surge Voltage (100ms max.) | 12V Input Models | -0.7 | --- | 25 | VDC | |
| | 24V Input Models | -0.7 | --- | 50 | | |
| | 48V Input Models | -0.7 | --- | 100 | | |
| Start-Up Threshold Voltage | 12V Input Models | --- | --- | 9 | | |
| | 24V Input Models | --- | --- | 18 | | |
| | 48V Input Models | --- | --- | 36 | | |
| Input Polarity Protection | None | | | | | |
| Start Up Time | Power Up | Nominal Vin and Constant Resistive Load | --- | --- | 30 | ms |
| | Remote On/Off | | --- | --- | 30 | ms |
| Internal Filter Type | All Models | LC Filter (for EN55022, Class A or Class B compliance see page 9) | | | | |
| Short Circuit Current | Hiccup Mode, 0.7Hz typ. | | | | | |

| Output Specifications | | | | | | |
|---------------------------------|--|---------------|------|-------|-------------------|---|
| Parameter | Conditions | Min. | Typ. | Max. | Unit | |
| Output Voltage Setting Accuracy | At 50% Load and Nominal Vin | --- | --- | ±1.0 | %Vnom. | |
| Output Voltage Balance | Dual Output, Balanced Loads | --- | --- | ±2.0 | % | |
| Line Regulation | Vin=Min. to Max. | --- | --- | ±0.2 | % | |
| Load Regulation | No Load to Full Load | Single Output | --- | --- | ±0.2 | % |
| | | Dual Output | --- | --- | ±1.0 | % |
| Cross Regulation (Dual) | Asymmetrical load 25% / 100% FL | --- | --- | ±5.0 | % | |
| Min.Load | No minimum Load Requirement | | | | | |
| Ripple & Noise (20MHz) | 3.3V & 5V Models | --- | 100 | --- | mV _{p-p} | |
| Ripple & Noise (20MHz) | 12V , 15V & Dual Models | --- | 150 | --- | mV _{p-p} | |
| Transient Recovery Time | 25% Load Step Change | --- | 250 | --- | µsec | |
| Temperature Coefficient | | --- | --- | ±0.02 | %/°C | |
| Over Load Protection | Current Limitation at 150% typ. of Iout max., Hiccup | | | | | |
| Short Circuit Protection | Hiccup Automatic Recovery | | | | | |
| Over Voltage Protection | For Shutdown Voltage see Model Selection Guide | | | | | |

| General Specifications | | | | | |
|-------------------------------|--|---------|------|------|-------|
| Parameter | Conditions | Min. | Typ. | Max. | Unit |
| I/O Isolation Voltage (rated) | 60 Seconds | 1500 | --- | --- | VDC |
| I/O Isolation Resistance | 500 VDC | 1000 | --- | --- | MΩ |
| I/O Isolation Capacitance | 100KHz, 1V | --- | --- | 2000 | pF |
| Switching Frequency | | --- | 285 | --- | KHz |
| MTBF(calculated) | MIL-HDBK-217F@25°C, Ground Benign | 372,000 | --- | --- | Hours |
| Safety Approvals(pending) | UL/cUL 60950-1 recognition(CSA certificate), IEC/EN 60950-1(CB-scheme) | | | | |

| Input Fuse | | |
|----------------------|-----------------------|-----------------------|
| 12V Input Models | 24V Input Models | 48V Input Models |
| 500mA Slow-Blow Type | 2500mA Slow-Blow Type | 1250mA Slow-Blow Type |

| Remote On/Off Control | | | | | |
|-----------------------------|------------------------------|----------------------------|------|------|------|
| Parameter | Conditions | Min. | Typ. | Max. | Unit |
| Converter On | | 3.5V ~ 12V or Open Circuit | | | |
| Converter Off | | 0V ~ 1.2V or Short Circuit | | | |
| Control Input Current (on) | Vctrl = 5.0V | --- | --- | 0.5 | mA |
| Control Input Current (off) | Vctrl = 0V | --- | --- | -0.5 | mA |
| Control Common | Referenced to Negative Input | | | | |
| Standby Input Current | Supply Off & Nominal Vin | --- | 3 | --- | mA |



Output Voltage Trim

| Parameter | Conditions | Min. | Typ. | Max. | Unit |
|----------------------|-----------------------------|------|------|------|------|
| Trim Up / Down Range | % of Nominal Output Voltage | ±10 | --- | --- | % |

Environmental Specifications

| Parameter | Model | Min. | Max. | | Unit |
|---|---------------------------------------|------|------------------|---------------|----------|
| | | | without Heatsink | with Heatsink | |
| Operating Ambient Temperature Range (Natural Convection, see Derating) | MJW25-24S033, MJW25-48S033 | -40 | 57 | 65 | °C |
| | MJW25-24S05, MJW25-24S12 | | 56 | 64 | |
| | MJW25-24S15, MJW25-48S05 | | | | |
| | MJW25-48S12, MJW25-48S15 | | | | |
| | MJW25-12S033 | | 50 | 61 | |
| | MJW25-12S05, MJW25-12S12, MJW25-12S15 | | | | |
| | MJW25-12D12, MJW25-12D15 | | | | |
| | MJW25-24D12, MJW25-24D15 | | | | |
| Thermal Impedance | MJW25-48D12, MJW25-48D15 | 17.6 | --- | --- | °C/W |
| | Natural Convection without Heatsink | 14.8 | --- | --- | °C/W |
| | Natural Convection with Heatsink | 13.6 | --- | --- | °C/W |
| | 100LFM Convection without Heatsink | 8.5 | --- | --- | °C/W |
| | 100LFM Convection with Heatsink | 11.8 | --- | --- | °C/W |
| | 200LFM Convection without Heatsink | 6.5 | --- | --- | °C/W |
| | 200LFM Convection with Heatsink | 8.8 | --- | --- | °C/W |
| | 400LFM Convection without Heatsink | 4.3 | --- | --- | °C/W |
| 400LFM Convection with Heatsink | --- | +105 | --- | °C | |
| Case Temperature | --- | -50 | +125 | --- | °C |
| Storage Temperature Range | --- | --- | 95 | --- | % rel. H |
| Humidity (non condensing) | Free-Air convection | | | | |
| Cooling | Six-Sided Shielded, Metal Case | | | | |
| RFI | --- | --- | 260 | --- | °C |
| Lead Temperature (1.5mm from case for 10Sec.) | | | | | |

EMC Specifications

| Parameter | Standards & Level | Performance |
|-----------------------------|--------------------------------------|------------------------------|
| EMI | EN55022 | Class A/Class B (See Page 9) |
| ESD | EN61000-4-2 air ± 8KV, Contact ± 6KV | Perf. Criteria A |
| Radiated immunity | EN61000-4-3 10V/m | Perf. Criteria A |
| Fast transient (See Note 7) | EN61000-4-4 ±2KV | Perf. Criteria A |
| Surge (See Note 7) | EN61000-4-5 ±1KV | Perf. Criteria A |
| Conducted immunity | EN61000-4-6 10V/m | Perf. Criteria A |



Power Derating Curve

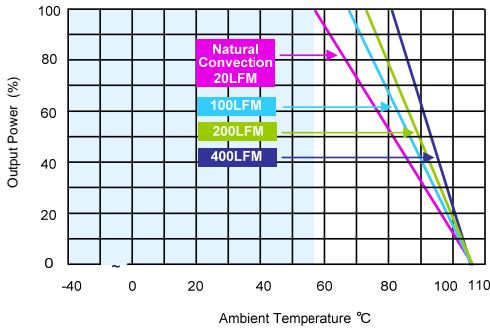

MJW25-24S033, MJW25-48S033
Derating Curve without Heatsink

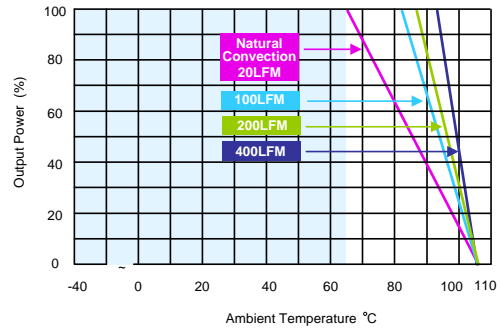

MJW25-24S033, MJW25-48S033
Derating Curve with Heatsink

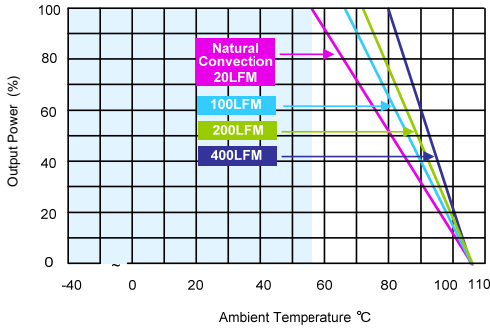

MJW25-24S05, MJW25-24S12, MJW25-24S15, MJW25-48S05
MJW25-48S12, MJW25-48S15 Derating Curve without Heatsink

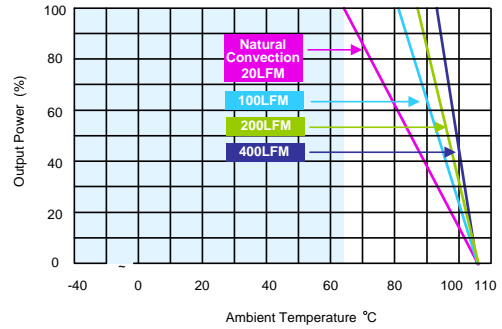

MJW25-24S05, MJW25-24S12, MJW25-24S15, MJW25-48S05
MJW25-48S12, MJW25-48S15 Derating Curve with Heatsink

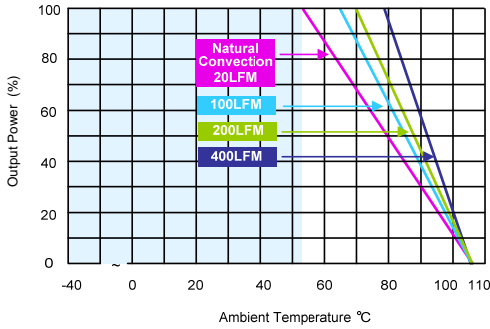

MJW25-12S033 Derating Curve without Heatsink

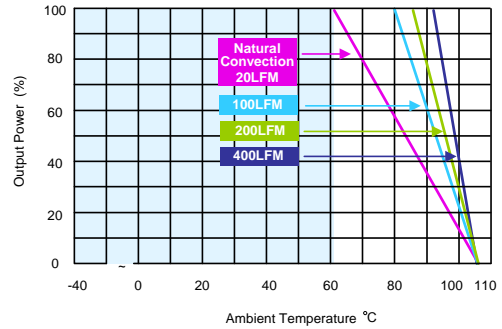

MJW25-12S033 Derating Curve with Heatsink

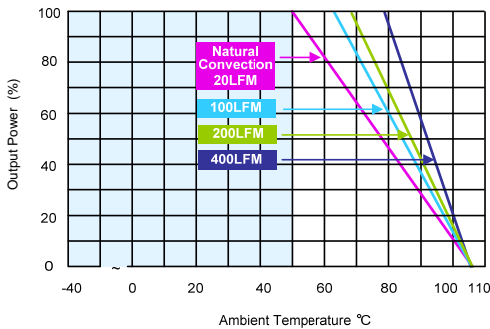

MJW25-12S05, MJW25-12S12, MJW25-12S15, MJW25-12D12
MJW25-12D15, MJW25-24D12, MJW25-24D15, MJW25-48D12, MJW25-48D15
Derating Curve without Heatsink

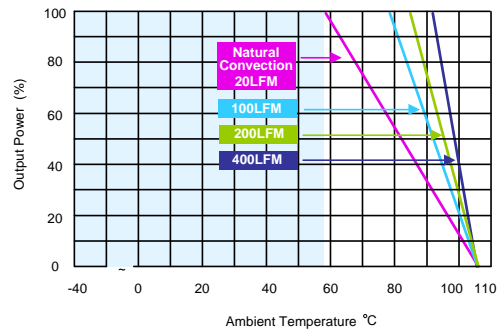

MJW25-12S05, MJW25-12S12, MJW25-12S15, MJW25-12D12
MJW25-12D15, MJW25-24D12, MJW25-24D15, MJW25-48D12, MJW25-48D15
Derating Curve with Heatsink





Efficiency Curve @25°C

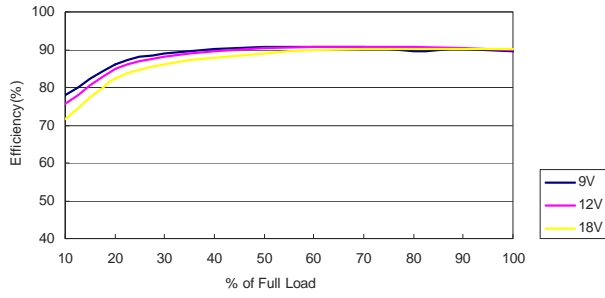

MJW25-12S033 Efficiency vs Load Current

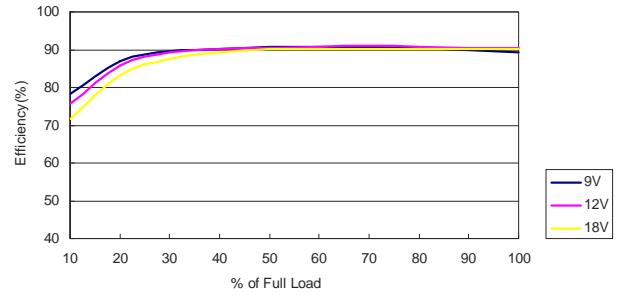

MJW25-12S05 Efficiency vs Load Current

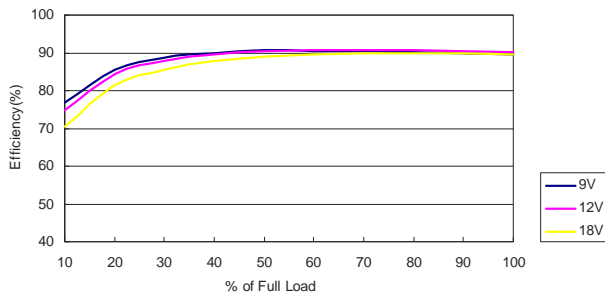

MJW25-12S12 Efficiency vs Load Current

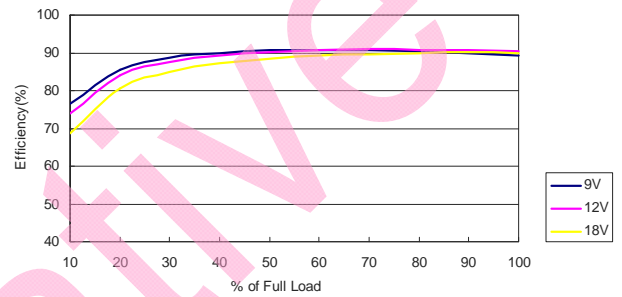

MJW25-12S15 Efficiency vs Load Current

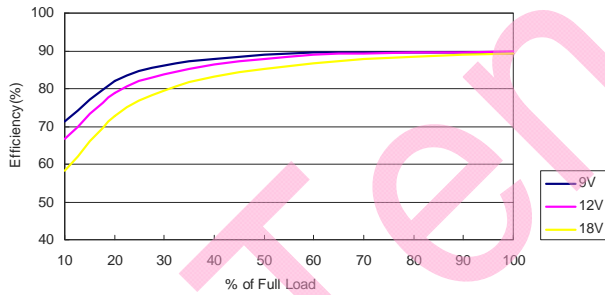

MJW25-12D12 Efficiency vs Load Current

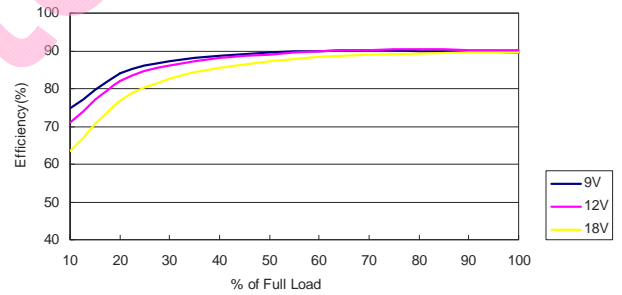

MJW25-12D15 Efficiency vs Load Current

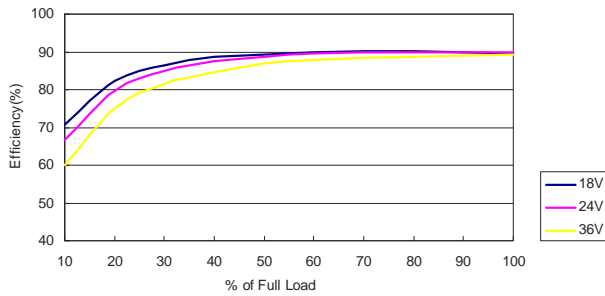

MJW25-24S033 Efficiency vs Load Current

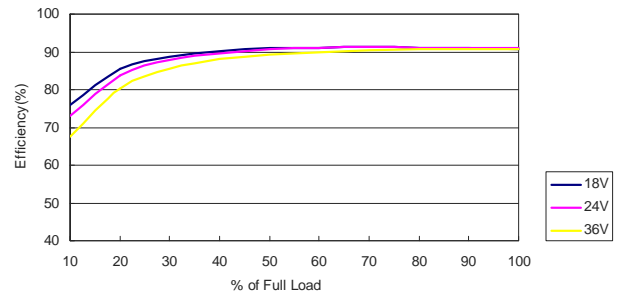

MJW25-24S05 Efficiency vs Load Current



Efficiency Curve @25°C

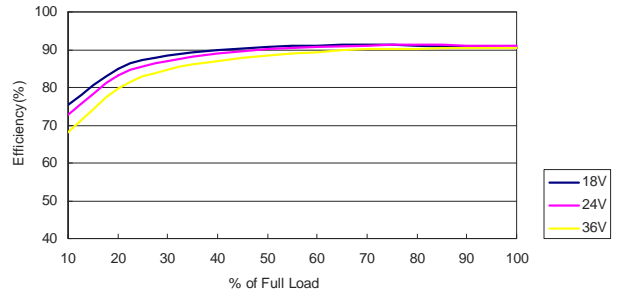
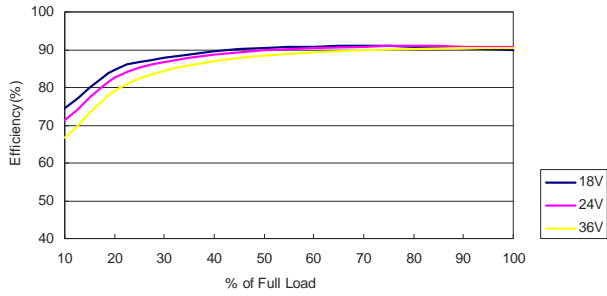

MJW25-24S12 Efficiency vs Load Current

MJW25-24S15 Efficiency vs Load Current

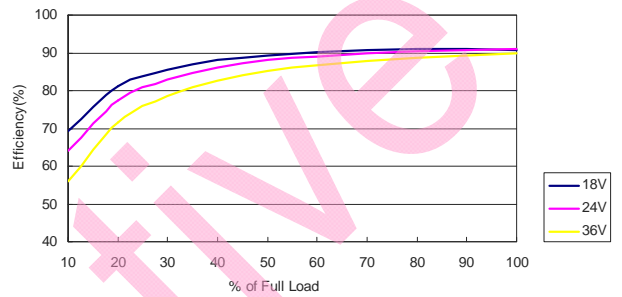
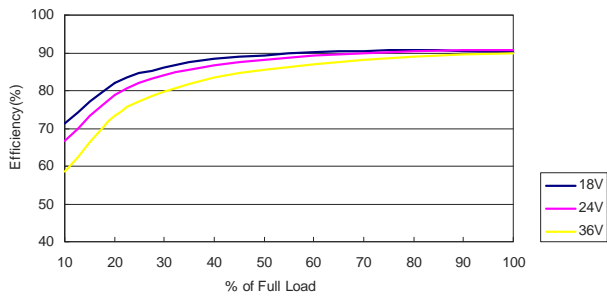

MJW25-24D12 Efficiency vs Load Current

MJW25-24D15 Efficiency vs Load Current

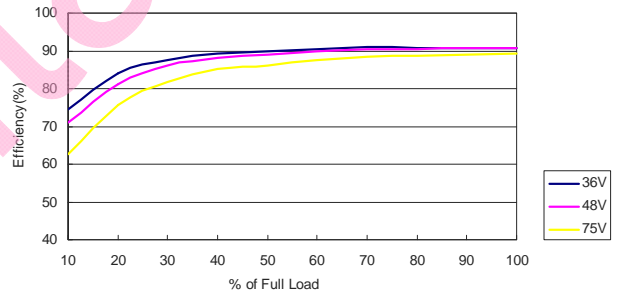
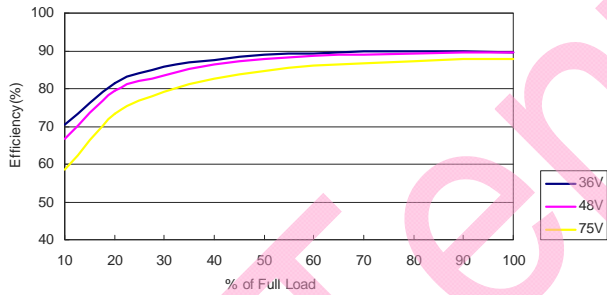

MJW25-48S033 Efficiency vs Load Current

MJW25-48S05 Efficiency vs Load Current

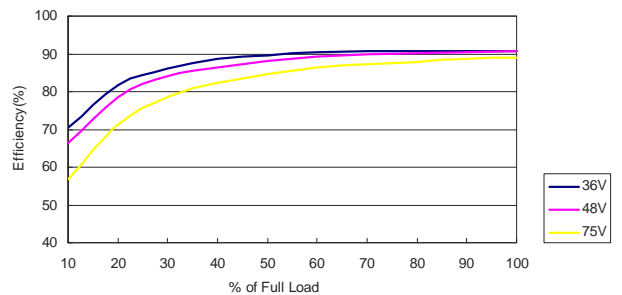
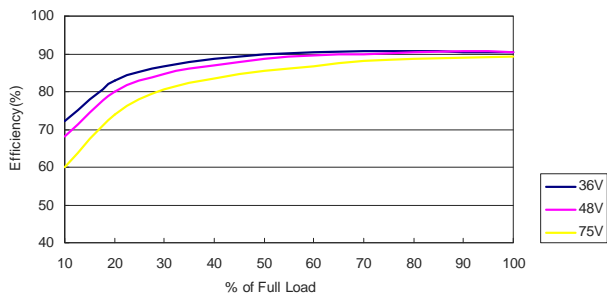

MJW25-48S12 Efficiency vs Load Current

MJW25-48S15 Efficiency vs Load Current



Efficiency Curve @25°C

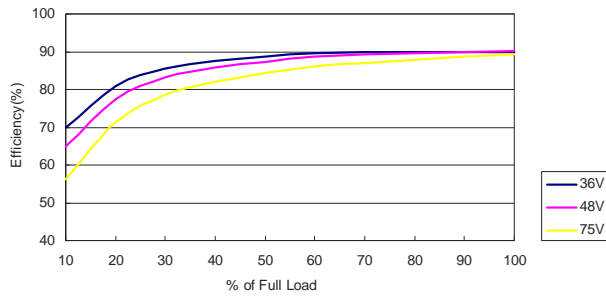

MJW25-48D12 Efficiency vs Load Current

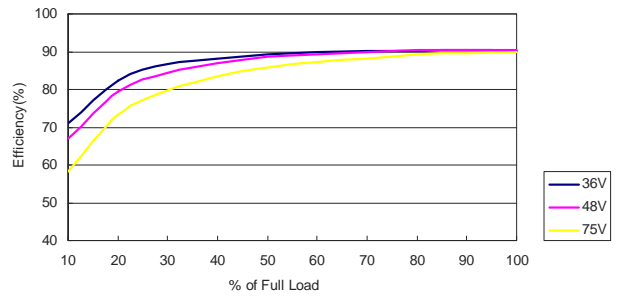

MJW25-48D15 Efficiency vs Load Current

Notes

- 1 Specifications typical at Ta=+25°C, resistive load, nominal input voltage, rated output current unless otherwise noted.
- 2 Transient recovery time is measured to within 1% error band for a step change in output load of 75% to 100%.
- 3 Ripple & Noise measurement bandwidth is 20 MHz, measured with a 1µF MLCC and a 10µF Tantalum Capacitor.
- 4 All DC/DC converters should be externally fused at the front end for protection.
- 5 Other input and output voltage may be available, please contact factory.
- 6 To order the converter with heatsink, please add a **suffix -HS** (e.g. MJW25-24S05-HS) to order code.
- 7 The MJW25 series can meet EN61000-4-4 & EN61000-4-5 by adding a capacitor across the input pins. Suggested capacitor: CHEMI-CON KY 220µF/100V.
- 8 That "natural convection" is about 20LFM but is not equal to still air (0 LFM).
- 9 Specifications are subject to change without notice.

Package Specifications

Mechanical Dimensions

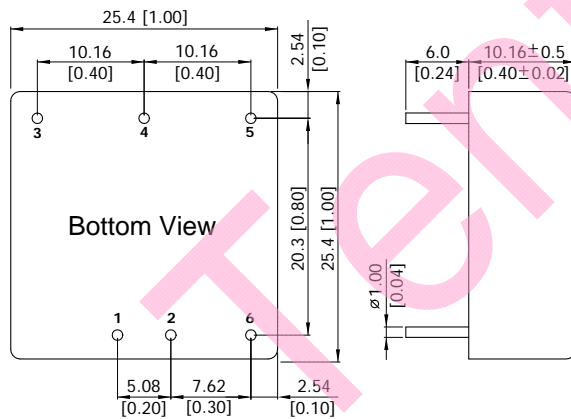

Pin Connections

| Pin | Single Output | Dual Output |
|-----|---------------|---------------|
| 1 | +Vin | +Vin |
| 2 | -Vin | -Vin |
| 3 | +Vout | +Vout |
| 4 | Trim | Common |
| 5 | -Vout | -Vout |
| 6 | Remote On/Off | Remote On/Off |

- ▶ All dimensions in mm (inches)
- ▶ Tolerance: X.X±0.25 (X.XX±0.01)
X.XX±0.13 (X.XXX±0.005)
- ▶ Pin diameter \varnothing 1.0 ±0.05 (0.04±0.002)

Physical Characteristics

| | |
|---------------|---|
| Case Size | : 25.4x25.4x10.16mm (1.0x1.0x0.4 inches) |
| Case Material | : Aluminium Alloy, Black Anodized Coating |
| Base Material | : FR4 PCB (flammability to UL 94V-0 rated) |
| Pin Material | : Copper Alloy with Gold Plate Over Nickel Subplate |
| Weight | : 16.5g |



Heatsink (Option –HS)

Mechanical Dimensions

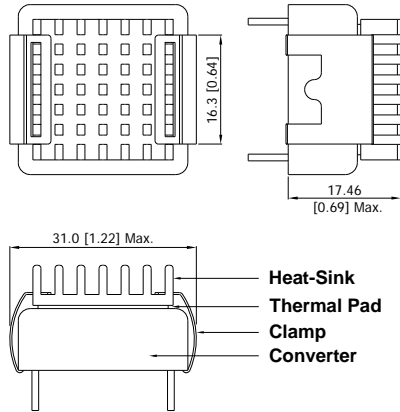

Heatsink Material: Aluminum
Finish: Anodic treatment (black)
Weight: 2g

► The advantages of adding a heatsink are:

1. To help heat dissipation and increase the stability and reliability of DC/DC converters at high operating temperature atmosphere.
2. To upgrade the operating temperature of DC/DC converters, please refer to Derating Curve.

External Output Trimming

Output can be externally trimmed by using the method shown below

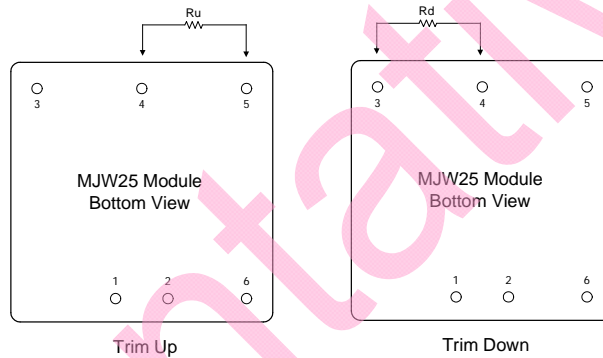

MJW25-XXS033 Trim Table

| | | | | | | | | | | | |
|-----------|---------|---------|---------|---------|---------|---------|---------|---------|---------|---------|-------|
| Trim down | 1 | 2 | 3 | 4 | 5 | 6 | 7 | 8 | 9 | 10 | % |
| Vout= | Vox0.99 | Vox0.98 | Vox0.97 | Vox0.96 | Vox0.95 | Vox0.94 | Vox0.93 | Vox0.92 | Vox0.91 | Vox0.90 | Volts |
| Rd= | 63.59 | 30.28 | 18.19 | 11.95 | 8.13 | 5.56 | 3.70 | 2.31 | 1.21 | 0.34 | KOhms |
| Trim up | 1 | 2 | 3 | 4 | 5 | 6 | 7 | 8 | 9 | 10 | % |
| Vout= | Vox1.01 | Vox1.02 | Vox1.03 | Vox1.04 | Vox1.05 | Vox1.06 | Vox1.07 | Vox1.08 | Vox1.09 | Vox1.10 | Volts |
| Ru= | 70.50 | 29.28 | 16.87 | 10.90 | 7.38 | 5.06 | 3.42 | 2.20 | 1.25 | 0.49 | KOhms |

MJW25-XXS05 Trim Table

| | | | | | | | | | | | |
|-----------|---------|---------|---------|---------|---------|---------|---------|---------|---------|---------|-------|
| Trim down | 1 | 2 | 3 | 4 | 5 | 6 | 7 | 8 | 9 | 10 | % |
| Vout= | Vox0.99 | Vox0.98 | Vox0.97 | Vox0.96 | Vox0.95 | Vox0.94 | Vox0.93 | Vox0.92 | Vox0.91 | Vox0.90 | Volts |
| Rd= | 45.53 | 20.61 | 12.31 | 8.15 | 5.66 | 4.00 | 2.81 | 1.92 | 1.23 | 0.68 | KOhms |
| Trim up | 1 | 2 | 3 | 4 | 5 | 6 | 7 | 8 | 9 | 10 | % |
| Vout= | Vox1.01 | Vox1.02 | Vox1.03 | Vox1.04 | Vox1.05 | Vox1.06 | Vox1.07 | Vox1.08 | Vox1.09 | Vox1.10 | Volts |
| Ru= | 36.57 | 16.58 | 9.92 | 6.59 | 4.59 | 3.25 | 2.30 | 1.59 | 1.03 | 0.59 | KOhms |

MJW25-XXS12 Trim Table

| | | | | | | | | | | | |
|-----------|---------|---------|---------|---------|---------|---------|---------|---------|---------|---------|-------|
| Trim down | 1 | 2 | 3 | 4 | 5 | 6 | 7 | 8 | 9 | 10 | % |
| Vout= | Vox0.99 | Vox0.98 | Vox0.97 | Vox0.96 | Vox0.95 | Vox0.94 | Vox0.93 | Vox0.92 | Vox0.91 | Vox0.90 | Volts |
| Rd= | 394.50 | 179.74 | 106.08 | 68.86 | 46.39 | 31.36 | 20.60 | 12.51 | 6.21 | 1.17 | KOhms |
| Trim up | 1 | 2 | 3 | 4 | 5 | 6 | 7 | 8 | 9 | 10 | % |
| Vout= | Vox1.01 | Vox1.02 | Vox1.03 | Vox1.04 | Vox1.05 | Vox1.06 | Vox1.07 | Vox1.08 | Vox1.09 | Vox1.10 | Volts |
| Ru= | 368.92 | 161.92 | 94.97 | 61.86 | 42.12 | 29.00 | 19.66 | 12.66 | 7.23 | 2.89 | KOhms |

MJW25-XXS15 Trim Table

| | | | | | | | | | | | |
|-----------|---------|---------|---------|---------|---------|---------|---------|---------|---------|---------|-------|
| Trim down | 1 | 2 | 3 | 4 | 5 | 6 | 7 | 8 | 9 | 10 | % |
| Vout= | Vox0.99 | Vox0.98 | Vox0.97 | Vox0.96 | Vox0.95 | Vox0.94 | Vox0.93 | Vox0.92 | Vox0.91 | Vox0.90 | Volts |
| Rd= | 572.67 | 248.63 | 145.60 | 94.97 | 64.87 | 44.92 | 30.72 | 20.10 | 11.86 | 5.28 | KOhms |
| Trim up | 1 | 2 | 3 | 4 | 5 | 6 | 7 | 8 | 9 | 10 | % |
| Vout= | Vox1.01 | Vox1.02 | Vox1.03 | Vox1.04 | Vox1.05 | Vox1.06 | Vox1.07 | Vox1.08 | Vox1.09 | Vox1.10 | Volts |
| Ru= | 392.98 | 182.12 | 108.73 | 71.43 | 48.85 | 33.71 | 22.86 | 14.69 | 8.33 | 3.23 | KOhms |



EMI-Filter to meet EN 55022, class A, class B; FCC part 15, level A

Conducted and radiated emissions EN55022 Class A, Class B

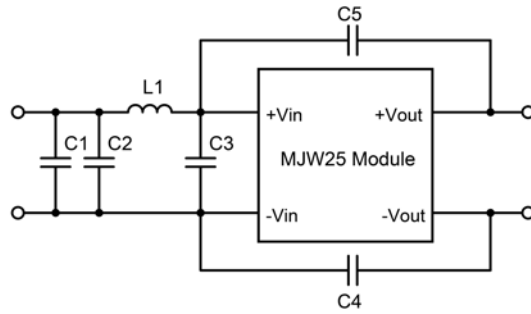

| Class | Model | C1 | C2 | C3 | C4&C5 | L1 |
|---------|-------------|----------------------|----------------------|----------------------|-----------------------|-------|
| Class A | MJW25-12XXX | None | 3.3µF/25V 1210 MLCC | None | None | 1µH |
| | MJW25-24XXX | None | 3.3µF/50V 1210 MLCC | None | None | 2.2µH |
| | MJW25-48XXX | None | 3.3µF/100V 1210 MLCC | None | None | 4.7µH |
| Class B | MJW25-12XXX | 3.3µF/25V 1210 MLCC | 3.3µF/25V 1210 MLCC | 3.3µF/25V 1210 MLCC | 1800 pF/2KV 1206 MLCC | 1µH |
| | MJW25-24XXX | 3.3µF/50V 1210 MLCC | 3.3µF/50V 1210 MLCC | 3.3µF/50V 1210 MLCC | 1800 pF/2KV 1206 MLCC | 2.2µH |
| | MJW25-48XXX | 3.3µF/100V 1210 MLCC | 3.3µF/100V 1210 MLCC | 3.3µF/100V 1210 MLCC | 1800 pF/2KV 1206 MLCC | 4.7µH |



Test Setup

Input Reflected-Ripple Current Test Setup

Input reflected-ripple current is measured with an inductor L_{in} (4.7 μ H) and C_{in} (220 μ F, ESR < 1.0 Ω at 100 KHz) to simulate source impedance. Capacitor C_{in} , offsets possible battery impedance. Current ripple is measured at the input terminals of the module, measurement bandwidth is 0-500 KHz.

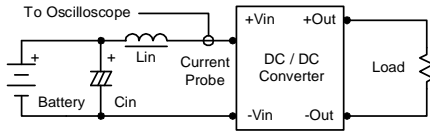

Peak-to-Peak Output Noise Measurement Test

Use a 1 μ F ceramic capacitor and a 10 μ F tantalum capacitor. Scope measurement should be made by using a BNC socket, measurement bandwidth is 0-20 MHz. Position the load between 50 mm and 75 mm from the DC/DC Converter.

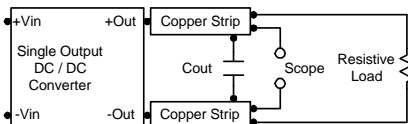

Technical Notes

Remote On/Off

Positive logic remote on/off turns the module on during a logic high voltage on the remote on/off pin, and off during a logic low. To turn the power module on and off, the user must supply a switch to control the voltage between the on/off terminal and the -Vin terminal. The switch can be an open collector or equivalent. A logic low is 0V to 1.2V. A logic high is 3.5V to 12V. The maximum sink current at the on/off terminal (Pin 6) during a logic low is -500 μ A. The maximum allowable leakage current of a switch connected to the on/off terminal (Pin 6) at logic high (3.5V to 12V) is 10mA.

Overcurrent Protection

To provide hiccup mode protection in a fault (output overload) condition, the unit is equipped with internal current limiting circuitry and can endure overload for an unlimited duration.

Overvoltage Protection

The output overvoltage clamp consists of control circuitry, which is independent of the primary regulation loop, that monitors the voltage on the output terminals. The control loop of the clamp has a higher voltage set point than the primary loop. This provides a redundant voltage control that reduces the risk of output overvoltage. The OVP level can be found in the output data.

Input Source Impedance

The power module should be connected to a low ac-impedance input source. Highly inductive source impedances can affect the stability of the power module. In applications where power is supplied over long lines and output loading is high, it may be necessary to use a capacitor at the input to ensure startup. Capacitor mounted close to the power module helps ensure stability of the unit, it is recommended to use a good quality low Equivalent Series Resistance (ESR < 1.0 Ω at 100 KHz) capacitor of a 10 μ F for the 24V and 48V devices.

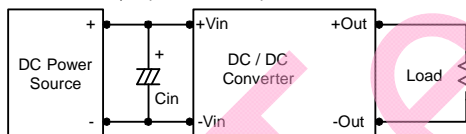

Output Ripple Reduction

A good quality low ESR capacitor placed as close as practicable across the load will give the best ripple and noise performance. To reduce output ripple, it is recommended to use 4.7 μ F capacitors at the output.

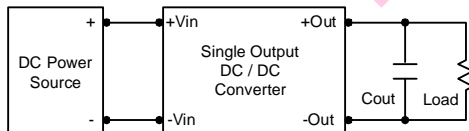

Maximum Capacitive Load

The MJW25 series has limitation of maximum connected capacitance at the output. The power module may be operated in current limiting mode during start-up, affecting the ramp-up and the startup time. The maximum capacitance can be found in the data sheet.

Thermal Considerations

Many conditions affect the thermal performance of the power module, such as orientation, airflow over the module and board spacing. To avoid exceeding the maximum temperature rating of the components inside the power module, the case temperature must be kept below 105°C. The derating curves are determined from measurements obtained in a test setup.

