

Metallized Polyester Film Capacitor Related Document: IEC 60384-2

MAIN APPLICATIONS:

Blocking, bypassing, filtering, timing, coupling and decoupling circuits, interference suppression in low voltage applications.

MARKING:

Manufacturer's logo/type/C-value/rated voltage/tolerance/
date of manufacture

DIELECTRIC:

Polyester film

ELECTRODES:

Vacuum deposited aluminum

COATING:

Flame retardant plastic case (UL-class 94 V-0), green, epoxy resin sealed

Flame class B according to IEC 60065 available on request

CONSTRUCTION:

Extended metallized film (refer to general information)

LEADS:

Tinned wire

IEC TEST CLASSIFICATION:

55/100/56, according to IEC 60068

TEMPERATURE RANGE:

- 55°C to + 100°C

CAPACITANCE RANGE:

1000pF to 15µF

CAPACITANCE TOLERANCES:

± 20% (M), ± 10% (K), ± 5% (J)

RATED VOLTAGES (U_R):

63 VDC, 100 VDC, 250 VDC, 400 VDC, 630 VDC, 1000 VDC

PERMISSIBLE AC VOLTAGES (RMS) UP TO 60Hz:

40 VAC, 63 VAC, 160 VAC, 200 VAC, 220 VAC, 220 VAC

TEST VOLTAGE (ELECTRODE/ELECTRODE):

1.6 x U_R for 2 s

INSULATION RESISTANCE:

Measured at 100 VDC (63 VDC series measured at 50 VDC) after one minute

For C ≤ 0.33µF and U_R > 100 VDC:

30,000 MΩ minimum value (100,000 MΩ typical value)

For C ≤ 0.33µF and U_R ≤ 100 VDC:

15,000 MΩ minimum value (50,000 MΩ typical value)

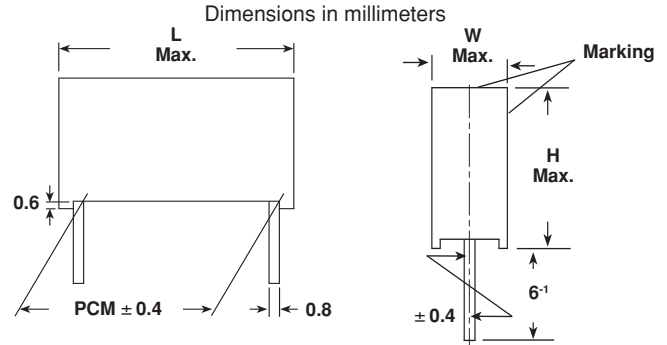

TIME CONSTANT:

Measured at 100 VDC (63 VDC series measured at 50 VDC) after one minute

For C > 0.33µF and U_R > 100 VDC:

10,000 s minimum value (40,000 s typical value)

For C > 0.33µF and U_R ≤ 100 VDC:

5000 s minimum value (15,000 s typical value)

CAPACITANCE DRIFT:

Up to + 40°C, ± 1.5% for a period of two years

DERATING FOR DC AND AC.

CATEGORY VOLTAGE U_C:

At + 85°C: U_C = 1.0 U_R

At + 100°C: U_C = 0.8 U_R

SELF INDUCTANCE:

~ 6 nH measured with 2mm long leads

PULL TEST ON LEADS:

≥ 30 N in direction of leads according to IEC 60068-2-21

RELIABILITY:

Operational life > 300,000 h

Failure rate < 2 FIT (40°C and 0.5 x U_R)

For further details, please refer to the general information provided in this catalog.

MAXIMUM PULSE RISE TIME

PCM (mm)	Maximum pulse rise time d _v /d _t [V/µs]					
	63 VDC	100 VDC	250 VDC	400 VDC	630 VDC	1000 VDC
10	11	13	22	37	60	130
15	7	8	13	21	33	65
22.5	4	5	8	13	19	34
27.5	3	4	6	10	14	25

If the maximum pulse voltage is less than the rated voltage higher d_v/d_t values can be permitted.

DISSIPATION FACTOR TAN δ

MEASURED AT	C ≤ 0.1µF	0.1µF < C ≤ 1.0µF	C > 1.0µF
1kHz	8 x 10 ⁻³	8 x 10 ⁻³	10 x 10 ⁻³
10kHz	15 x 10 ⁻³	15 x 10 ⁻³	—
100kHz	25 x 10 ⁻³	—	—
Maximum values			

CAPACITANCE	CAPACITANCE CODE	VOLTAGE CODE 06 63 VDC/40 VAC				VOLTAGE CODE 01 100 VDC/63 VAC				VOLTAGE CODE 25 250 VDC/160 VAC			
		W	H	L	PCM	W	H	L	PCM	W	H	L	PCM
1000 pF	- 210	—	—	—	—	—	—	—	—	—	—	—	—
1500 pF	- 215	—	—	—	—	—	—	—	—	—	—	—	—
2200 pF	- 222	—	—	—	—	—	—	—	—	—	—	—	—
3300 pF	- 233	—	—	—	—	—	—	—	—	—	—	—	—
4700 pF	- 247	—	—	—	—	—	—	—	—	—	—	—	—
6800 pF	- 268	—	—	—	—	—	—	—	—	—	—	—	—
0.01 μ F	- 310	—	—	—	—	—	—	—	—	—	—	—	—
0.015 μ F	- 315	—	—	—	—	—	—	—	—	—	—	—	—
0.022 μ F	- 322	—	—	—	—	—	—	—	—	—	—	—	—
0.033 μ F	- 333	—	—	—	—	—	—	—	—	4.0	9.0	13.0	10
0.047 μ F	- 347	—	—	—	—	—	—	—	—	4.0	9.0	13.0	10
0.068 μ F	- 368	—	—	—	—	4.0	9.0	13.0	10	4.5	9.5	13.0	10
0.1 μ F	- 410	—	—	—	—	4.0	9.0	13.0	10	5.5	10.5	18.0	15
0.15 μ F	- 415	—	—	—	—	4.0	9.0	13.0	10	5.5	10.5	18.0	15
0.22 μ F	- 422	4.0	9.0	13.0	10	4.5	9.5	13.0	10	5.5	10.5	18.0	15
0.33 μ F	- 433	4.0	9.0	13.0	10	5.5	10.5	18.0	15	6.5	12.5	18.0	15
0.47 μ F	- 447	5.5	10.5	13.0	10	5.5	10.5	18.0	15	6.5	14.5	26.5	22.5
0.68 μ F	- 468	5.5	10.5	18.0	15	6.5	12.5	18.0	15	7.5	15.5	26.5	22.5
1.0 μ F	- 510	5.5	10.5	18.0	15	7.5	13.5	18.0	15	8.5	16.5	26.5	22.5
1.5 μ F	- 515	6.5	12.5	18.0	15	7.5	15.5	26.5	22.5	9.0	18.5	31.5	27.5
2.2 μ F	- 522	7.5	13.5	18.0	15	8.5	16.5	26.5	22.5	11.5	20.5	31.5	27.5
3.3 μ F	- 533	7.5	15.5	26.5	22.5	10.5	18.5	26.5	22.5	13.5	23.5	31.5	27.5
4.7 μ F	- 547	8.5	16.5	26.5	22.5	11.5	20.5	31.5	27.5	—	—	—	—
6.8 μ F	- 568	10.5	18.5	26.5	22.5	13.5	23.5	31.5	27.5	—	—	—	—
10.0 μ F	- 610	11.5	20.5	31.5	27.5	15.0	24.5	31.5	27.5	—	—	—	—
15.0 μ F	- 615	13.5	23.5	31.5	27.5	16.5	29.5	31.5	27.5	—	—	—	—

RECOMMENDED PACKAGING

LETTER CODE	TYPE OF PACKAGING	HEIGHT (H) (mm)	REEL DIAMETER (mm)	ORDERING CODE EXAMPLE	PCM	PCM	PCM
					10	15	22.5 - 27.5
D	AMMO	16.5	S*	MKT 1822-422-065-D	X	X	—
G	AMMO	18.5	S*	MKT 1822-422-065-G	X	X	—
F	REEL	16.5	350	MKT 1822-422-065-F	X	X	—
W	REEL	18.5	350	MKT 1822-422-065-W	X	X	—
V	REEL	18.5	500	MKT 1822-510-255-V	—	X	X
G	AMMO	18.5	L*	MKT 1822-510-255-G	—	—	X
—	BULK	—	—	MKT 1822-510-255	X	X	X

*S = box size 55 x 210 x 340mm (W x H x L)

*L = box size 60 x 360 x 510mm (W x H x L)



CAPACITANCE	CAPACITANCE CODE	VOLTAGE CODE 40 400 VDC/200 VAC				VOLTAGE CODE 63* 630 VDC/220 VAC				VOLTAGE CODE 10* 1000 VDC/220 VAC			
		W	H	L	PCM	W	H	L	PCM	W	H	L	PCM
1000 pF	- 210	4.0	9.0	13.0	10	4.0	9.0	13.0	10	4.0	9.0	13.0	10
1500 pF	- 215	4.0	9.0	13.0	10	4.0	9.0	13.0	10	4.0	9.0	13.0	10
2200 pF	- 222	4.0	9.0	13.0	10	4.0	9.0	13.0	10	4.0	9.0	13.0	10
3300 pF	- 233	4.0	9.0	13.0	10	4.0	9.0	13.0	10	4.0	9.0	13.0	10
4700 pF	- 247	4.0	9.0	13.0	10	4.0	9.0	13.0	10	5.5	10.5	13.0	10
6800 pF	- 268	4.0	9.0	13.0	10	4.0	9.0	13.0	10	6.5	11.5	13.0	10
0.01 µF	- 310	4.0	9.0	13.0	10	4.0	9.0	13.0	10	5.5	10.5	18.0	15
0.015 µF	- 315	4.0	9.0	13.0	10	5.5	10.5	13.0	10	6.5	12.5	18.0	15
0.022 µF	- 322	4.0	9.0	13.0	10	6.5	11.5	13.0	10	7.5	13.5	18.0	15
0.033 µF	- 333	4.0	9.0	13.0	10	5.5	10.5	18.0	15	6.5	14.5	26.5	22.5
0.047 µF	- 347	5.5	10.5	18.0	15	6.5	12.5	18.0	15	7.5	15.5	26.5	22.5
0.068 µF	- 368	5.5	10.5	18.0	15	7.5	13.5	18.0	15	8.5	16.5	26.5	22.5
0.1 µF	- 410	5.5	10.5	18.0	15	6.5	14.5	26.5	22.5	10.5	18.5	26.5	22.5
0.15 µF	- 415	6.5	12.5	18.0	15	7.5	15.5	26.5	22.5	11.5	20.5	31.5	27.5
0.22 µF	- 422	7.5	15.5	26.5	22.5	8.5	16.5	26.5	22.5	13.5	23.5	31.5	27.5
0.33 µF	- 433	8.5	16.5	26.5	22.5	11.5	20.5	31.5	27.5	16.5	29.5	31.5	27.5
0.47 µF	- 447	10.5	18.5	26.5	22.5	11.5	20.5	31.5	27.5	20.0	35.0	31.5	27.5
0.68 µF	- 468	11.5	20.5	31.5	27.5	13.5	23.5	31.5	27.5	—	—	—	—
1.0 µF	- 510	11.5	20.5	31.5	27.5	15.0	24.5	31.5	27.5	—	—	—	—
1.5 µF	- 515	13.5	23.5	31.5	27.5	—	—	—	—	—	—	—	—
2.2 µF	- 522	—	—	—	—	—	—	—	—	—	—	—	—
3.3 µF	- 533	—	—	—	—	—	—	—	—	—	—	—	—
4.7 µF	- 547	—	—	—	—	—	—	—	—	—	—	—	—
6.8 µF	- 568	—	—	—	—	—	—	—	—	—	—	—	—
10.0 µF	- 610	—	—	—	—	—	—	—	—	—	—	—	—
15.0 µF	- 615	—	—	—	—	—	—	—	—	—	—	—	—

Further C-values upon request.

*Not suitable for mains applications.

Please refer to X-capacitors in our catalog "RFI Suppression Components".

RECOMMENDED PACKAGING

LETTER CODE	TYPE OF PACKAGING	HEIGHT (H) (mm)	REEL DIAMETER (mm)	ORDERING CODE EXAMPLE	PCM		
					10	15	22.5 - 27.5
D	AMMO	16.5	S*	MKT 1822-422-065-D	X	X	—
G	AMMO	18.5	S*	MKT 1822-422-065-G	X	X	—
F	REEL	16.5	350	MKT 1822-422-065-F	X	X	—
W	REEL	18.5	350	MKT 1822-422-065-W	X	X	—
V	REEL	18.5	500	MKT 1822-510-255-V	—	X	X
G	AMMO	18.5	L*	MKT 1822-510-255-G	—	—	X
—	BULK	—	—	MKT 1822-522-255	X	X	X

*S = box size 55 x 210 x 340mm (W x H x L)

*L = box size 60 x 360 x 510mm (W x H x L)

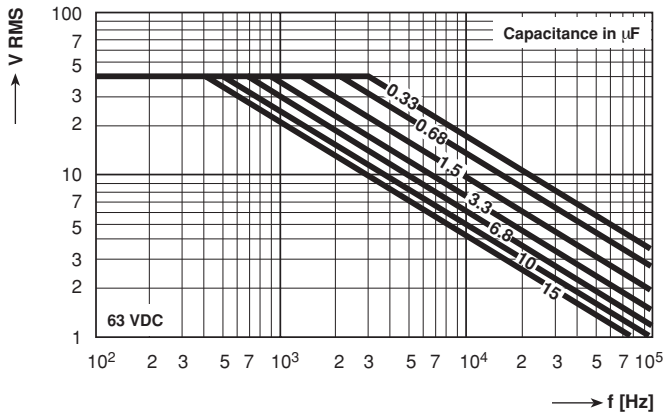

Permissible AC Voltage versus Frequency

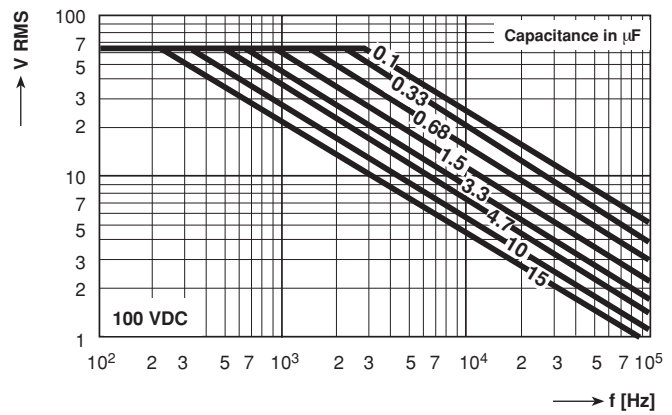

Permissible AC Voltage versus Frequency

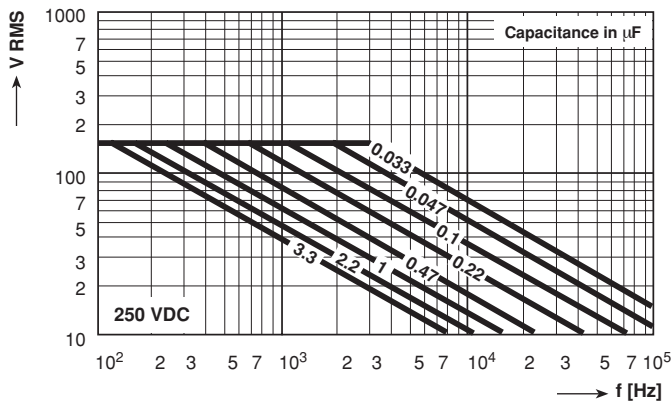

Permissible AC Voltage versus Frequency

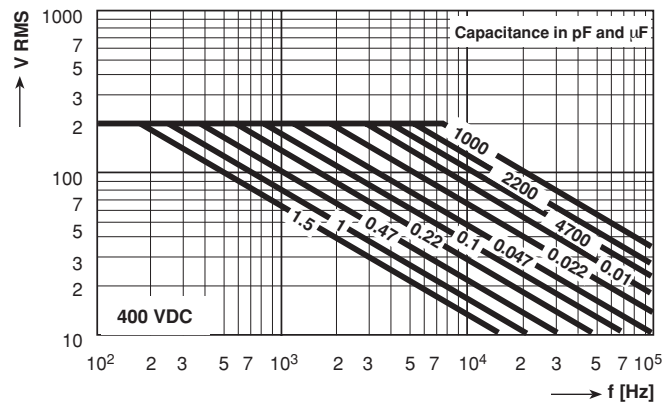

Permissible AC Voltage versus Frequency

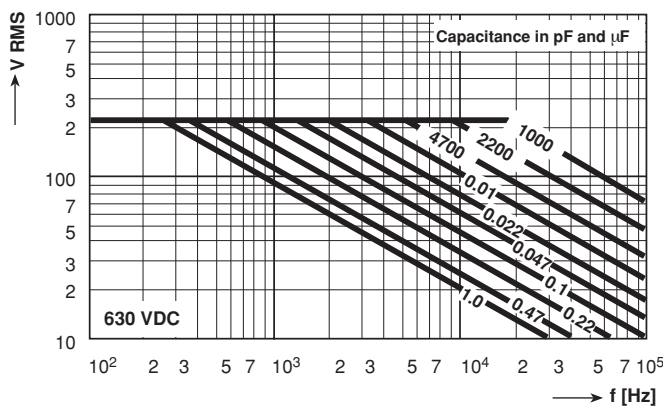

Permissible AC Voltage versus Frequency

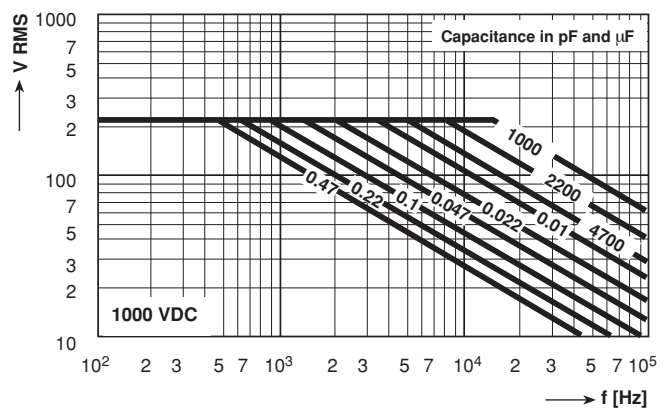

Permissible AC Voltage versus Frequency