

Surface Mount Zener Diode

MM3Z Series

A suffix of "-C" specifies halogen & RoHS compliant

200mW, SOD-323(SC-76)

Electrical Characteristics (T_A = 25°C unless otherwise specified)

Type Number	Marking Code	Zener Voltage Range (Note 2)				@I _{ZT}	Maximum Zener Impedance (Note 3)			Maximum Reverse Current (Note 2)		Temperature Coefficient of Zener Voltage @ I _{ZT} = 5 mA mV / °C	
		V _Z			mV		Z _{ZT} @I _{ZT}	Z _{ZK} @I _{ZK}		I _R @ V _R		Min	Max
		Min	Nom	Max				Ω	Ω	mA	μA		
		V	V	V			Ω	Ω	mA	μA	V		
MM3Z2V0	0H, WY	1.91	2.0	2.09	5	100	600	1.0	150	1.0	-3.5	0	
MM3Z2V4	00, WX	2.2	2.4	2.6	5	100	600	1.0	50	1.0	-3.5	0	
MM3Z2V7	01, W1	2.5	2.7	2.9	5	100	600	1.0	20	1.0	-3.5	0	
MM3Z3V0	02, W2	2.8	3.0	3.2	5	95	600	1.0	10	1.0	-3.5	0	
MM3Z3V3	05, W3	3.1	3.3	3.5	5	95	600	1.0	5	1.0	-3.5	0	
MM3Z3V6	06, W4	3.4	3.6	3.8	5	90	600	1.0	5	1.0	-3.5	0	
MM3Z3V9	07, W5	3.7	3.9	4.1	5	90	600	1.0	3	1.0	-3.5	0	
MM3Z4V3	08, W6	4.0	4.3	4.6	5	90	600	1.0	3	1.0	-3.5	0	
MM3Z4V7	09, W7	4.4	4.7	5.0	5	80	500	1.0	3	2.0	-3.5	0.2	
MM3Z5V1	0A, W8	4.8	5.1	5.4	5	60	480	1.0	2	2.0	-2.7	1.2	
MM3Z5V6	0C, W9	5.2	5.6	6.0	5	40	400	1.0	1	2.0	-2.0	2.5	
MM3Z6V2	0E, WA	5.8	6.2	6.6	5	10	150	1.0	3	4.0	0.4	3.7	
MM3Z6V8	0F, WB	6.4	6.8	7.2	5	15	80	1.0	2	4.0	1.2	4.5	
MM3Z7V5	0G, WC	7.0	7.5	7.9	5	15	80	1.0	1	5.0	2.5	5.3	
MM3Z8V2	0H, WD	7.7	8.2	8.7	5	15	80	1.0	0.7	5.0	3.2	6.2	
MM3Z9V1	0K, WE	8.5	9.1	9.6	5	15	100	1.0	0.5	6.0	3.8	7.0	
MM3Z10V	0L, WF	9.4	10	10.6	5	20	150	1.0	0.2	7.0	4.5	8.0	
MM3Z11V	0M, WG	10.4	11	11.6	5	20	150	1.0	0.1	8.0	5.4	9.0	
MM3Z12V	0N, WH	11.4	12	12.7	5	25	150	1.0	0.1	8.0	6.0	10	
MM3Z13V	0P, WI	12.4	13.3	14.1	5	30	170	1.0	0.1	8.0	7.0	11	
MM3Z15V	0T, WJ	14.3	15	15.8	5	30	200	1.0	0.1	10.5	9.2	13	
MM3Z16V	0U, WK	15.3	16.2	17.1	5	40	200	1.0	0.1	11.2	10.4	14	
MM3Z18V	0W, WL	16.8	18	19.1	5	45	225	1.0	0.1	12.6	12.4	16	
MM3Z20V	0Z, WM	18.8	20	21.2	5	55	225	1.0	0.1	14.0	14.4	18	
MM3Z22V	10, WN	20.8	22	23.3	5	55	250	1.0	0.1	15.4	16.4	20	
MM3Z24V	11, WO	22.8	24.2	25.6	5	70	250	1.0	0.1	16.8	18.4	22	
MM3Z27V	12, WP	25.1	27	28.9	2	80	300	0.5	0.05	18.9	21.4	25.3	
MM3Z30V	14, WQ	28	30	32	2	80	300	0.5	0.05	21.0	24.4	29.4	
MM3Z33V	18, WR	31	33	35	2	80	325	0.5	0.05	23.2	27.4	33.4	
MM3Z36V	19, WS	34	36	38	2	90	350	0.5	0.05	25.2	30.4	37.4	
MM3Z39V	20, WT	37	39	41	2	130	350	0.5	0.05	27.3	33.4	41.2	
MM3Z43V	21, WU	40	43	46	2	150	500	0.5	0.05	30.1	37.6	46.6	
MM3Z47V	1A, WV	44	47	50	2	170	500	0.5	0.05	32.9	42.0	51.8	
MM3Z51V	1C, WW	48	51	54	2	180	500	0.5	0.05	35.7	46.6	57.2	
MM3Z56V	1D, 1W	52	56	60	2	200	500	0.5	0.05	39.2	52.2	63.8	
MM3Z62V	1E, 2W	58	62	66	2	215	500	0.5	0.05	43.4	58.8	71.6	
MM3Z68V	1F, 3W	64	68	72	2	240	500	0.5	0.05	47.6	65.6	79.8	
MM3Z75V	1G, 4W	70	75	79	2	255	500	0.5	0.05	52.5	73.4	88.6	

- Notes: 1. Valid provided that device terminals are kept at ambient temperature.
 2. Test with pulses. period = 5 ms, pulse width = 300 μs
 3. f = 1 K Hz

• Maximum Ratings @ T_A = 25 °C

Characteristic	Symbol	Value	Unit
Power Dissipation (Note 1), Derate above 25 °C	P _d	200 1.5	mW mW / °C
Forward Voltage (Note 2) @ I _F = 10 mA	V _F	0.9	V
Thermal Resistance from Junction to Ambient (Note 1)	R _{θJA}	625	°C / W
Operating and Storage Temperature Range	T _i , T _{STG}	-65 ~ +150	°C

- Note: 1. Valid provided that device terminals are kept at ambient temperature.
 2. Short duration test pulse used in minimize self-heating effect.
 3. f = 1 K Hz

● **Features**

- . RoHS Compliant
- . Standard Zener Breakdown Voltage Range -2.0V to 75V
- . Steady State Power Rating of 200 mW
- . Small Body Outline Dimensions: 1.7 mm x 1.25 mm
- . Low Body Height: 0.9 mm
- . Package Weight: 4.507 mg/unit
- . ESD Rating of Class 3 (>16 KV) per Human Body Model

● **Mechanical Data**

- . Case: SOD-323, Void-free, transfer-molded plastic
- . Finish: All external surfaces are corrosion resistant
- . Maximum Case Temperature For Soldering Purposes: 260 °C for 10 Seconds
- . Polarity: Cathode indicated by polarity band
- . Flammability Rating: UL94 V-0
- . Mounting Position: Any

● **Outline**

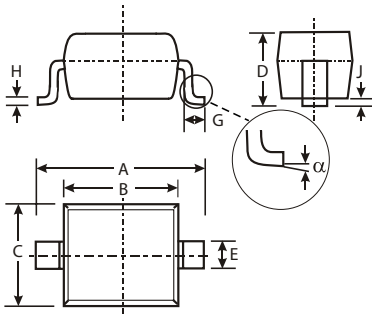

SOD-323 (SC-76)		
Dim	Min	Max
A	2.30	2.70
B	1.60	1.80
C	1.20	1.40
D	1.05 Typical	
E	0.25	0.35
G	0.20	0.40
H	0.10	0.15
J	0.05 Typical	
α	0°	8°
All Dimensions in mm		

● **Typical Characteristics**

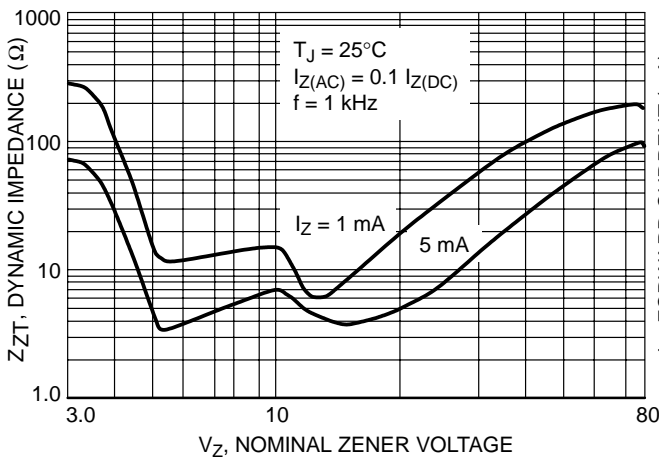

Figure 1. Effect of Zener Voltage on Zener Impedance

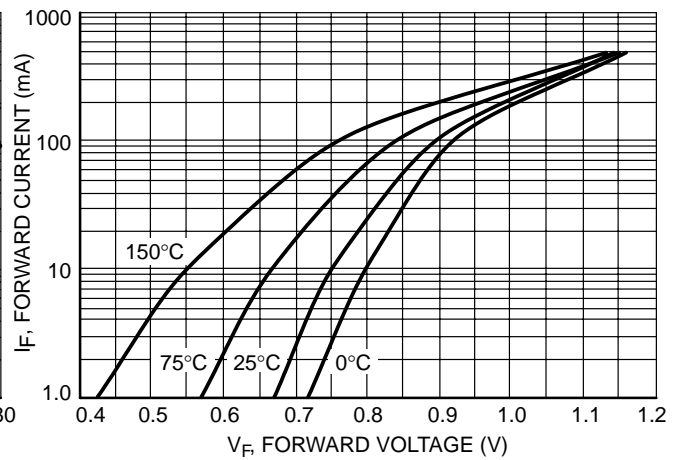

Figure 2. Typical Forward Voltage

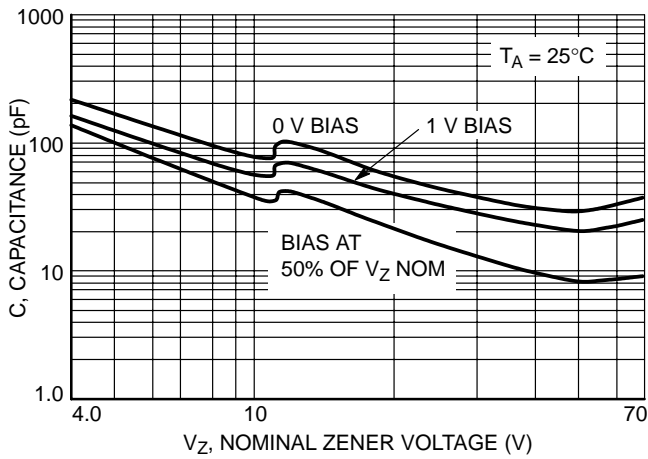

Figure 3. Typical Capacitance

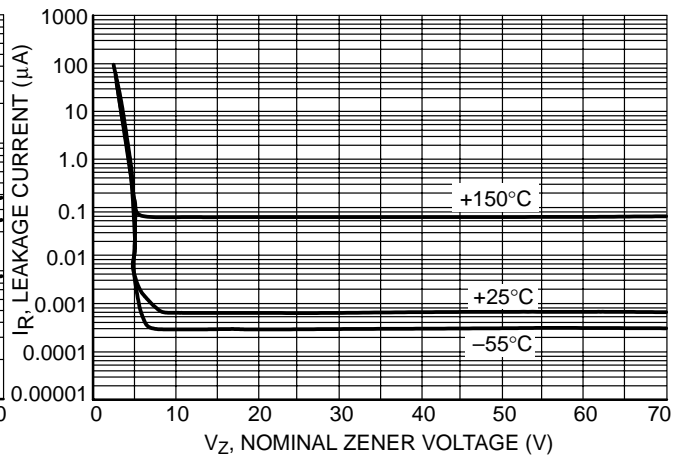

Figure 4. Typical Leakage Current

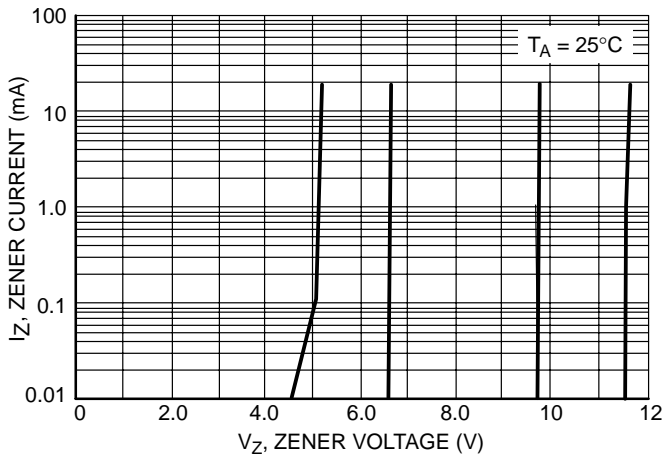

Figure 5. Zener Voltage versus Zener Current (V_Z Up to 12 V)

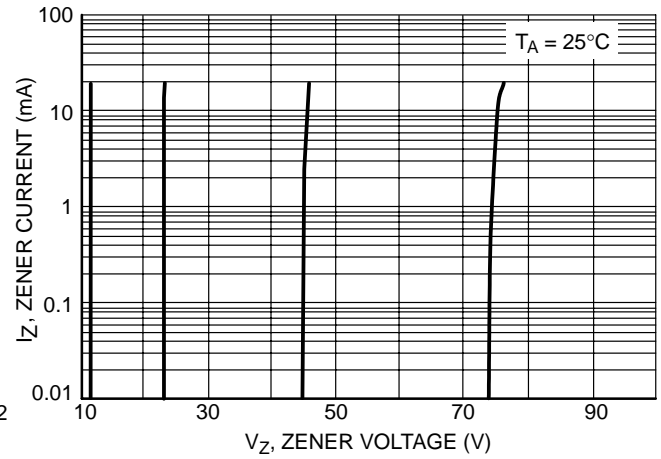

Figure 6. Zener Voltage versus Zener Current (12 V to 75 V)

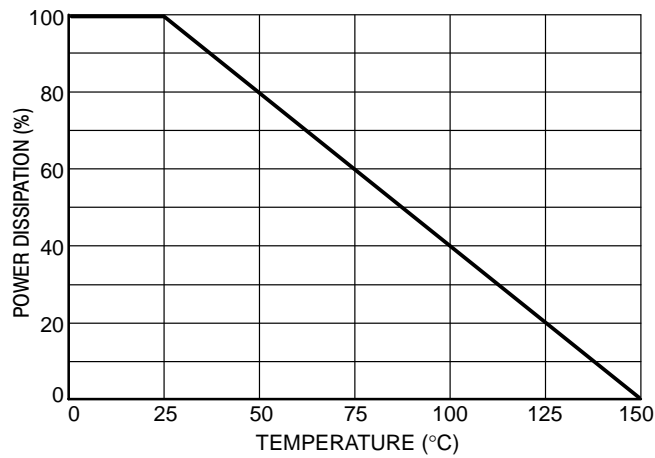

Figure 7. Steady State Power Derating