

MMBFJ309LT1, MMBFJ310LT1

JFET - VHF/UHF Amplifier Transistor

N-Channel



ON Semiconductor®

<http://onsemi.com>

Features

- Pb-Free Packages are Available

MAXIMUM RATINGS

Rating	Symbol	Value	Unit
Drain-Source Voltage	V_{DS}	25	Vdc
Gate-Source Voltage	V_{GS}	25	Vdc
Gate Current	I_G	10	mAdc

THERMAL CHARACTERISTICS

Characteristic	Symbol	Max	Unit
Total Device Dissipation FR-5 Board, (Note 1) $T_A = 25^\circ\text{C}$ Derate above 25°C	P_D	225 1.8	mW mW/ $^\circ\text{C}$
Thermal Resistance, Junction-to-Ambient	$R_{\theta JA}$	556	$^\circ\text{C}/\text{W}$
Junction and Storage Temperature	T_J, T_{stg}	-55 to +150	$^\circ\text{C}$

Maximum ratings are those values beyond which device damage can occur. Maximum ratings applied to the device are individual stress limit values (not normal operating conditions) and are not valid simultaneously. If these limits are exceeded, device functional operation is not implied, damage may occur and reliability may be affected.

1. FR-5 = 1.0 x 0.75 x 0.062 in.

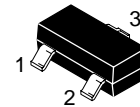
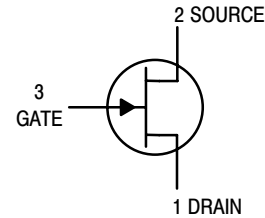

SOT-23 (TO-236)
CASE 318
STYLE 10

MARKING DIAGRAM

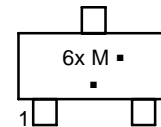

6x = Device Code
x = U for MMBFJ309LT1
x = T for MMBFJ310LT1

M = Date Code*
■ = Pb-Free Package

(Note: Microdot may be in either location)
*Date Code orientation and/or overbar may vary depending upon manufacturing location.

ORDERING INFORMATION

Device	Package	Shipping†
MMBFJ309LT1	SOT-23	3,000 / Tape & Reel
MMBFJ309LT1G	SOT-23 (Pb-Free)	3,000 / Tape & Reel
MMBFJ310LT1	SOT-23	3,000 / Tape & Reel
MMBFJ310LT1G	SOT-23 (Pb-Free)	3,000 / Tape & Reel

†For information on tape and reel specifications, including part orientation and tape sizes, please refer to our Tape and Reel Packaging Specifications Brochure, BRD8011/D.

MMBFJ309LT1, MMBFJ310LT1

ELECTRICAL CHARACTERISTICS ($T_A = 25^\circ\text{C}$ unless otherwise noted)

Characteristic		Symbol	Min	Typ	Max	Unit
OFF CHARACTERISTICS						
Gate–Source Breakdown Voltage ($I_G = -1.0 \mu\text{Adc}$, $V_{DS} = 0$)		$V_{(BR)GSS}$	-25	-	-	Vdc
Gate Reverse Current ($V_{GS} = -15 \text{ Vdc}$) ($V_{GS} = -15 \text{ Vdc}$, $T_A = 125^\circ\text{C}$)		I_{GSS}	-	-	-1.0 -1.0	nAdc μAdc
Gate Source Cutoff Voltage ($V_{DS} = 10 \text{ Vdc}$, $I_D = 1.0 \text{ nAdc}$)	MMBFJ309 MMBFJ310	$V_{GS(off)}$	-1.0 -2.0	- -	-4.0 -6.5	Vdc
ON CHARACTERISTICS						
Zero–Gate–Voltage Drain Current ($V_{DS} = 10 \text{ Vdc}$, $V_{GS} = 0$)	MMBFJ309 MMBFJ310	I_{DSS}	12 24	- -	30 60	mAdc
Gate–Source Forward Voltage ($I_G = 1.0 \text{ mAdc}$, $V_{DS} = 0$)		$V_{GS(f)}$	-	-	1.0	Vdc
SMALL–SIGNAL CHARACTERISTICS						
Forward Transfer Admittance ($V_{DS} = 10 \text{ Vdc}$, $I_D = 10 \text{ mAdc}$, $f = 1.0 \text{ kHz}$)		$ Y_{fs} $	8.0	-	18	mmhos
Output Admittance ($V_{DS} = 10 \text{ Vdc}$, $I_D = 10 \text{ mAdc}$, $f = 1.0 \text{ kHz}$)		$ y_{os} $	-	-	250	μmhos
Input Capacitance ($V_{GS} = -10 \text{ Vdc}$, $V_{DS} = 0 \text{ Vdc}$, $f = 1.0 \text{ MHz}$)		C_{iss}	-	-	5.0	pF
Reverse Transfer Capacitance ($V_{GS} = -10 \text{ Vdc}$, $V_{DS} = 0 \text{ Vdc}$, $f = 1.0 \text{ MHz}$)		C_{rss}	-	-	2.5	pF
Equivalent Short–Circuit Input Noise Voltage ($V_{DS} = 10 \text{ Vdc}$, $I_D = 10 \text{ mAdc}$, $f = 100 \text{ Hz}$)		\bar{e}_n	-	10	-	$\text{nV}/\sqrt{\text{Hz}}$

MMBFJ309LT1, MMBFJ310LT1

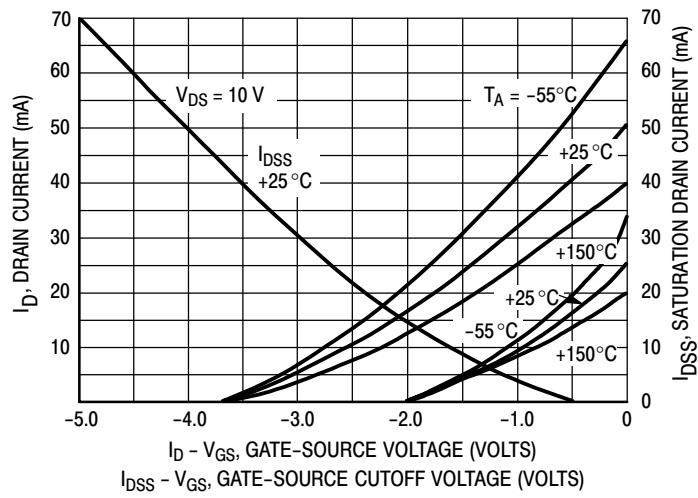

Figure 1. Drain Current and Transfer Characteristics versus Gate-Source Voltage

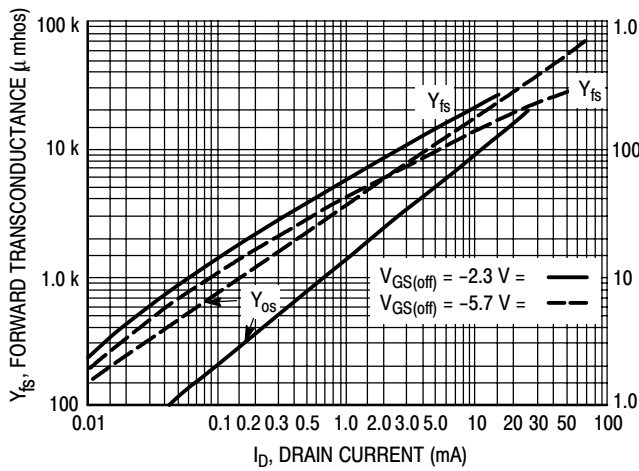

Figure 2. Common-Source Output Admittance and Forward Transconductance versus Drain Current

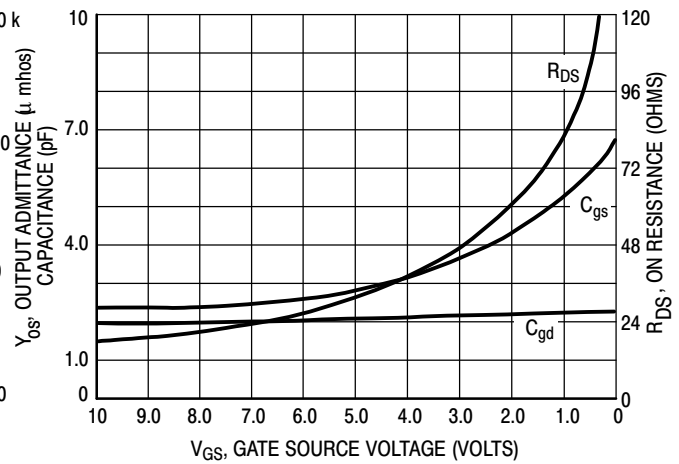

Figure 3. On Resistance and Junction Capacitance versus Gate-Source Voltage

MMBFJ309LT1, MMBFJ310LT1

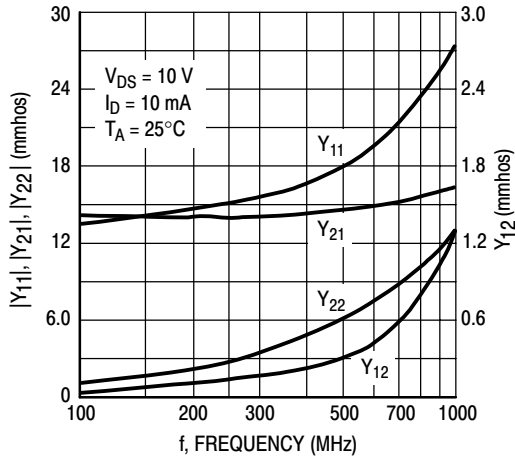

Figure 4. Common-Gate Y Parameter Magnitude versus Frequency

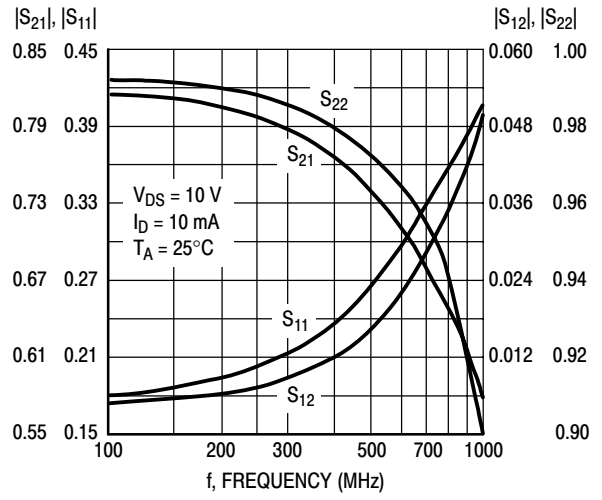

Figure 5. Common-Gate S Parameter Magnitude versus Frequency

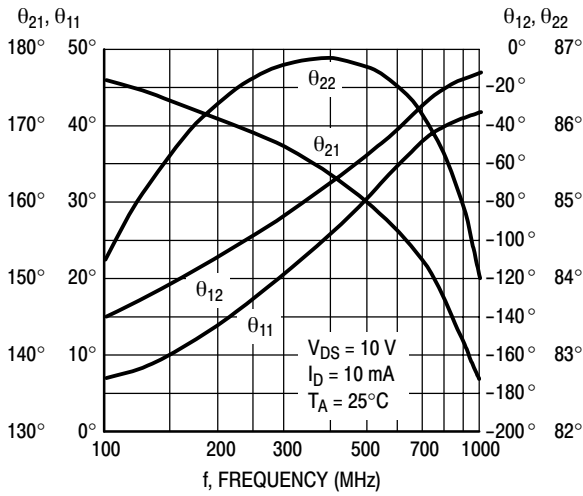

Figure 6. Common-Gate Y Parameter Phase-Angle versus Frequency

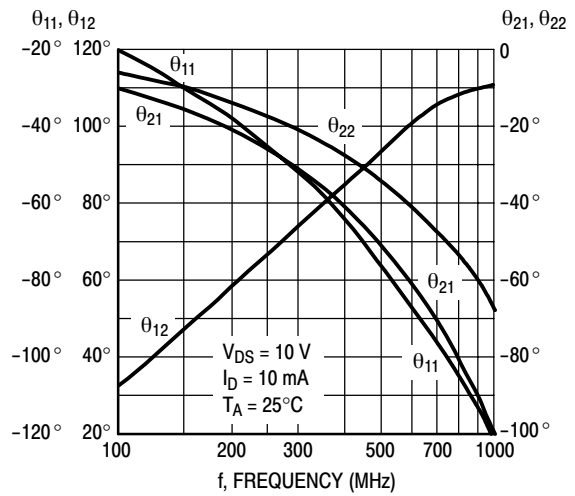
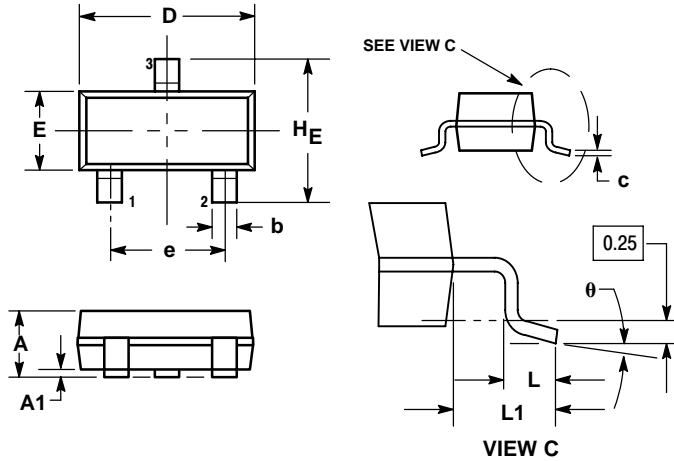

Figure 7. S Parameter Phase-Angle versus Frequency

MMBFJ309LT1, MMBFJ310LT1

PACKAGE DIMENSIONS

SOT-23 (TO-236)
CASE 318-08
ISSUE AN



NOTES:

1. DIMENSIONING AND TOLERANCING PER ANSI Y14.5M, 1982.
2. CONTROLLING DIMENSION: INCH.
3. MAXIMUM LEAD THICKNESS INCLUDES LEAD FINISH THICKNESS. MINIMUM LEAD THICKNESS IS THE MINIMUM THICKNESS OF BASE MATERIAL.
4. 318-01 THRU -07 AND -09 OBSOLETE, NEW STANDARD 318-08.

DIM	MILLIMETERS			INCHES		
	MIN	NOM	MAX	MIN	NOM	MAX
A	0.89	1.00	1.11	0.035	0.040	0.044
A1	0.01	0.06	0.10	0.001	0.002	0.004
b	0.37	0.44	0.50	0.015	0.018	0.020
c	0.09	0.13	0.18	0.003	0.005	0.007
D	2.80	2.90	3.04	0.110	0.114	0.120
E	1.20	1.30	1.40	0.047	0.051	0.055
e	1.78	1.90	2.04	0.070	0.075	0.081
L	0.10	0.20	0.30	0.004	0.008	0.012
L1	0.35	0.54	0.69	0.014	0.021	0.029
HE	2.10	2.40	2.64	0.083	0.094	0.104

STYLE 10:

1. DRAIN
2. SOURCE
3. GATE

SOLDERING FOOTPRINT*

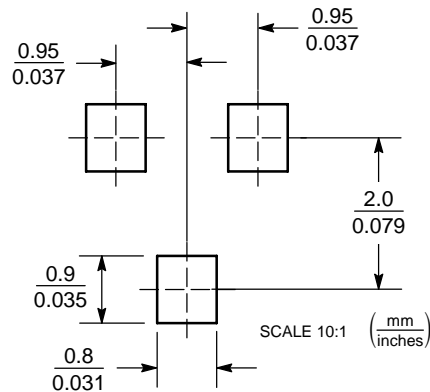

*For additional information on our Pb-Free strategy and soldering details, please download the ON Semiconductor Soldering and Mounting Techniques Reference Manual, SOLDERRM/D.

ON Semiconductor and are registered trademarks of Semiconductor Components Industries, LLC (SCILLC). SCILLC reserves the right to make changes without further notice to any products herein. SCILLC makes no warranty, representation or guarantee regarding the suitability of its products for any particular purpose, nor does SCILLC assume any liability arising out of the application or use of any product or circuit, and specifically disclaims any and all liability, including without limitation special, consequential or incidental damages. "Typical" parameters which may be provided in SCILLC data sheets and/or specifications can and do vary in different applications and actual performance may vary over time. All operating parameters, including "Typicals" must be validated for each customer application by customer's technical experts. SCILLC does not convey any license under its patent rights nor the rights of others. SCILLC products are not designed, intended, or authorized for use as components in systems intended for surgical implant into the body, or other applications intended to support or sustain life, or for any other application in which the failure of the SCILLC product could create a situation where personal injury or death may occur. Should Buyer purchase or use SCILLC products for any such unintended or unauthorized application, Buyer shall indemnify and hold SCILLC and its officers, employees, subsidiaries, affiliates, and distributors harmless against all claims, costs, damages, and expenses, and reasonable attorney fees arising out of, directly or indirectly, any claim of personal injury or death associated with such unintended or unauthorized use, even if such claim alleges that SCILLC was negligent regarding the design or manufacture of the part. SCILLC is an Equal Opportunity/Affirmative Action Employer. This literature is subject to all applicable copyright laws and is not for resale in any manner.

PUBLICATION ORDERING INFORMATION

LITERATURE FULFILLMENT:

Literature Distribution Center for ON Semiconductor
P.O. Box 61312, Phoenix, Arizona 85082-1312 USA
Phone: 480-829-7710 or 800-344-3860 Toll Free USA/Canada
Fax: 480-829-7709 or 800-344-3867 Toll Free USA/Canada
Email: orderlit@onsemi.com

N. American Technical Support: 800-282-9855 Toll Free
USA/Canada

Japan: ON Semiconductor, Japan Customer Focus Center
2-9-1 Kamimeguro, Meguro-ku, Tokyo, Japan 153-0051
Phone: 81-3-5773-3850

ON Semiconductor Website: <http://onsemi.com>

Order Literature: <http://www.onsemi.com/litorder>

For additional information, please contact your local Sales Representative.