

NPN SMALL SIGNAL SURFACE MOUNT TRANSISTOR
Features

- Epitaxial Planar Die Construction
- Complementary PNP Type Available (MMBT2907A)
- Ideal for Low Power Amplification and Switching
- **Lead, Halogen and Antimony Free, RoHS Compliant (Note 2)**
- **“Green” Device (Note 3)**
- **Qualified to AEC-Q101 Standards for High Reliability**

Mechanical Data

- Case: SOT-23
- Case Material: Molded Plastic, “Green” Molding Compound, Note 5. UL Flammability Classification Rating 94V-0
- Moisture Sensitivity: Level 1 per J-STD-020D
- Terminals: Lead Free Plating (Matte Tin Finish annealed over Alloy 42 leadframe). Solderable per MIL-STD-202, Method 208
- Terminal Connections: See Diagram
- Marking Information: See Page 4
- Ordering Information: See Page 4
- Weight: 0.008 grams (approximate)



Top View

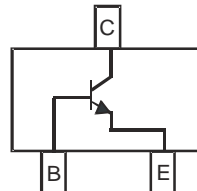

Device Schematic

Maximum Ratings @ $T_A = 25^\circ\text{C}$ unless otherwise specified

Characteristic	Symbol	Value	Unit
Collector-Base Voltage	V_{CBO}	75	V
Collector-Emitter Voltage	V_{CEO}	40	V
Emitter-Base Voltage	V_{EBO}	6.0	V
Collector Current - Continuous	I_C	600	mA
Peak Collector Current	I_{CM}	800	mA

Thermal Characteristics

Characteristic	Symbol	Value	Unit
Power Dissipation (Note 1)	P_D	300	mW
Thermal Resistance, Junction to Ambient (Note 1)	$R_{\theta JA}$	417	$^\circ\text{C}/\text{W}$
Operating and Storage Temperature Range	T_J, T_{STG}	-55 to +150	$^\circ\text{C}$

- Notes:
1. Device mounted on FR-4 PCB, 1 inch x 0.85 inch x 0.062 inch; pad layout as shown on Diodes Inc. suggested pad layout document AP02001, which can be found on our website at <http://www.diodes.com/datasheets/ap02001.pdf>.
 2. No purposefully added lead. Halogen and Antimony Free.
 3. Product manufactured with Data Code V9 (week 33, 2008) and newer are built with Green Molding Compound. Product manufactured prior to Date Code V9 are built with Non-Green Molding Compound and may contain Halogens or Sb_2O_3 Fire Retardants.

Electrical Characteristics @ $T_A = 25^\circ\text{C}$ unless otherwise specified

Characteristic (Note 4)	Symbol	Min	Max	Unit	Test Condition
OFF CHARACTERISTICS					
Collector-Base Breakdown Voltage	$V_{(BR)CBO}$	75	—	V	$I_C = 10\mu\text{A}, I_E = 0$
Collector-Emitter Breakdown Voltage	$V_{(BR)CEO}$	40	—	V	$I_C = 10\text{mA}, I_B = 0$
Emitter-Base Breakdown Voltage	$V_{(BR)EBO}$	6.0	—	V	$I_E = 10\mu\text{A}, I_C = 0$
Collector Cutoff Current	I_{CBO}	—	10	nA μA	$V_{CB} = 60\text{V}, I_E = 0$ $V_{CB} = 60\text{V}, I_E = 0, T_A = 150^\circ\text{C}$
Collector Cutoff Current	I_{CEX}	—	10	nA	$V_{CE} = 60\text{V}, V_{EB(OFF)} = 3.0\text{V}$
Emitter Cutoff Current	I_{EBO}	—	10	nA	$V_{EB} = 3.0\text{V}, I_C = 0$
Base Cutoff Current	I_{BL}	—	20	nA	$V_{CE} = 60\text{V}, V_{EB(OFF)} = 3.0\text{V}$
ON CHARACTERISTICS (Note 4)					
DC Current Gain	h_{FE}	35	—	—	$I_C = 100\mu\text{A}, V_{CE} = 10\text{V}$
		50	—		$I_C = 1.0\text{mA}, V_{CE} = 10\text{V}$
		75	—		$I_C = 10\text{mA}, V_{CE} = 10\text{V}$
		100	300		$I_C = 150\text{mA}, V_{CE} = 10\text{V}$
		40	—		$I_C = 500\text{mA}, V_{CE} = 10\text{V}$
		50	—		$I_C = 10\text{mA}, V_{CE} = 10\text{V}, T_A = -55^\circ\text{C}$
35	—	$I_C = 150\text{mA}, V_{CE} = 1.0\text{V}$			
Collector-Emitter Saturation Voltage	$V_{CE(SAT)}$	—	0.3 1.0	V	$I_C = 150\text{mA}, I_B = 15\text{mA}$ $I_C = 500\text{mA}, I_B = 50\text{mA}$
Base-Emitter Saturation Voltage	$V_{BE(SAT)}$	0.6	1.2 2.0	V	$I_C = 150\text{mA}, I_B = 15\text{mA}$ $I_C = 500\text{mA}, I_B = 50\text{mA}$
SMALL SIGNAL CHARACTERISTICS					
Output Capacitance	C_{obo}	—	8	pF	$V_{CB} = 10\text{V}, f = 1.0\text{MHz}, I_E = 0$
Input Capacitance	C_{ibo}	—	25	pF	$V_{EB} = 0.5\text{V}, f = 1.0\text{MHz}, I_C = 0$
Current Gain-Bandwidth Product	f_T	300	—	MHz	$V_{CE} = 20\text{V}, I_C = 20\text{mA}, f = 100\text{MHz}$
Noise Figure	NF	—	4.0	dB	$V_{CE} = 10\text{V}, I_C = 100\mu\text{A}, R_S = 1.0\text{k}\Omega, f = 1.0\text{kHz}$
SWITCHING CHARACTERISTICS					
Delay Time	t_d	—	10	ns	$V_{CC} = 30\text{V}, I_C = 150\text{mA}, V_{BE(off)} = -0.5\text{V}, I_{B1} = 15\text{mA}$
Rise Time	t_r	—	25	ns	$V_{CC} = 3.0\text{V}, I_C = 150\text{mA}, I_{B1} = 15\text{mA}, V_{BE(OFF)} = 0.5\text{V}$
Storage Time	t_s	—	225	ns	$V_{CC} = 30\text{V}, I_C = 150\text{mA}, I_{B1} = I_{B2} = 15\text{mA}$
Fall Time	t_f	—	60	ns	$V_{CC} = 30\text{V}, I_C = 150\text{mA}, I_{B1} = I_{B2} = 15\text{mA}$

Notes: 4. Short duration pulse test used to minimize self-heating effect.

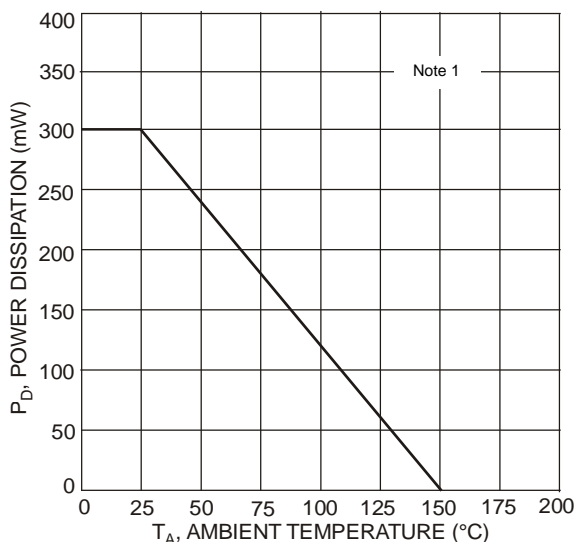

Fig. 1 Power Dissipation vs. Ambient Temperature

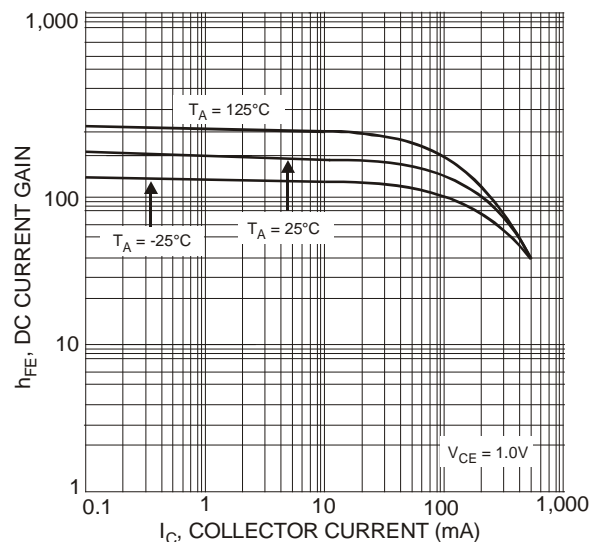

Fig. 2 Typical DC Current Gain vs. Collector Current

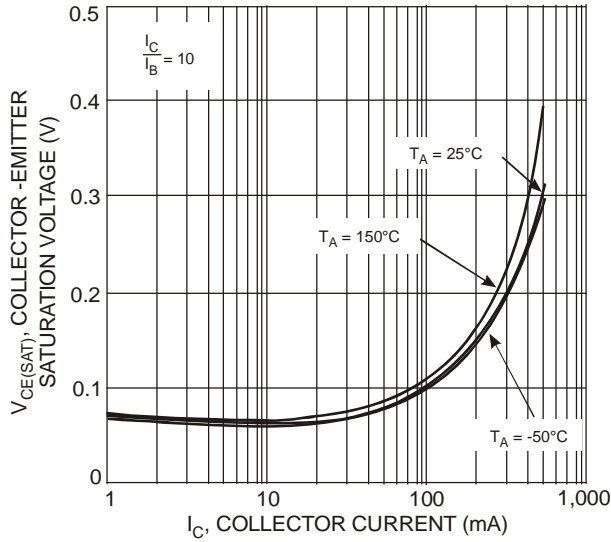

Fig. 3 Typical Collector-Emitter Saturation Voltage vs. Collector Current

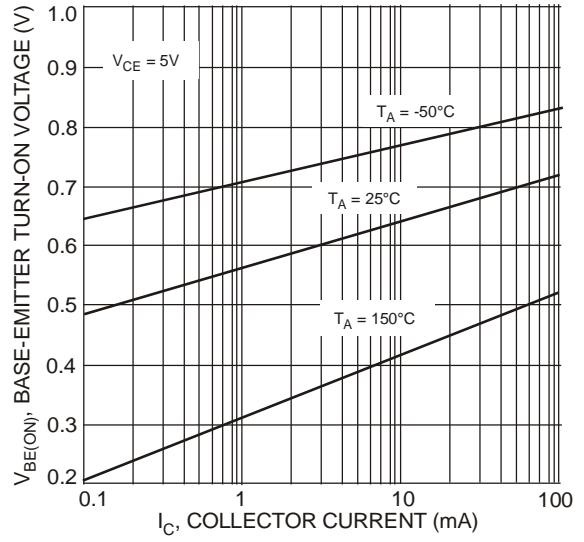

Fig. 4 Base-Emitter Turn-On Voltage vs. Collector Current

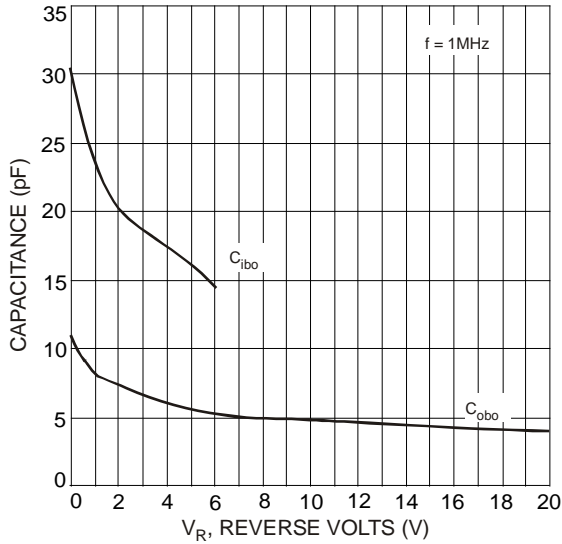

Fig. 5 Typical Capacitance Characteristics

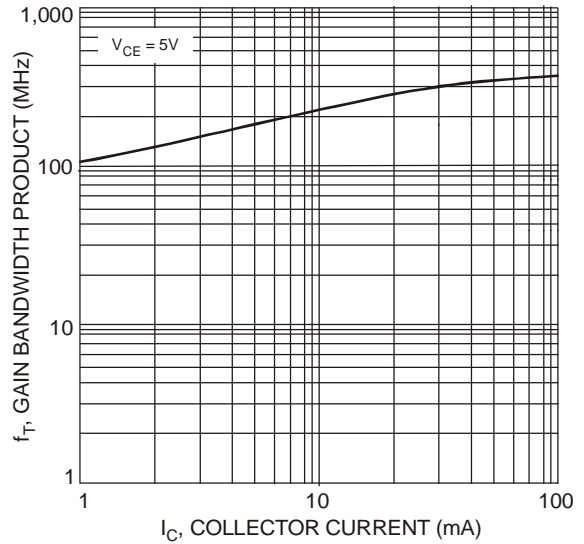

Fig. 6 Typical Gain Bandwidth Product vs. Collector Current

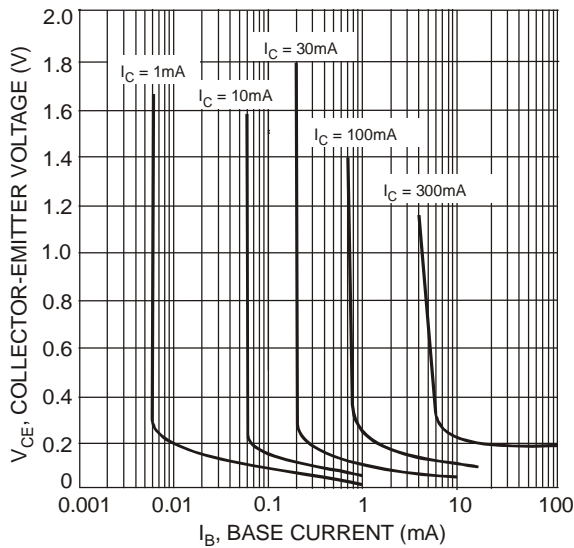

Fig. 7 Typical Collector Saturation Region

Ordering Information (Note 5)

Part Number MMBT2222A-7-F	Case SOT-23	Packaging 3000/Tape & Reel
-------------------------------------	-----------------------	--------------------------------------

Notes: 5. For packaging details, go to our website at <http://www.diodes.com/datasheets/ap02007.pdf>.

Marking Information

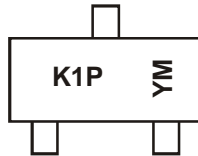

K1P = Product Type Marking Code
 YM = Date Code Marking
 Y = Year (ex: N = 2002)
 M = Month (ex: 9 = September)

Date Code Key

Year	1998	1999	2000	2001	2002	2003	2004	2005	2006	2007	2008	2009	2010	2011	2012	2013	2014	2015
Code	J	K	L	M	N	P	R	S	T	U	V	W	X	Y	Z	A	B	C
Month	Jan	Feb	Mar	Apr	May	Jun	Jul	Aug	Sep	Oct	Nov	Dec						
Code	1	2	3	4	5	6	7	8	9	O	N	D						

Package Outline Dimensions

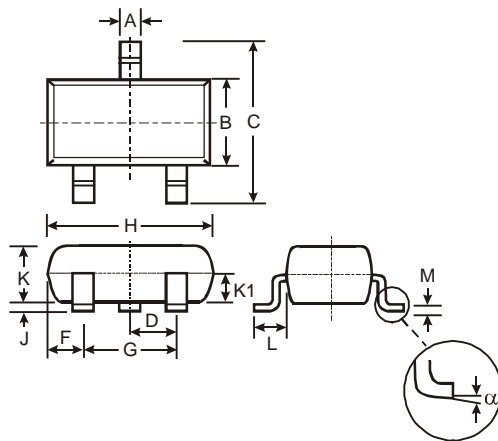

SOT-23			
Dim	Min	Max	Typ
A	0.37	0.51	0.40
B	1.20	1.40	1.30
C	2.30	2.50	2.40
D	0.89	1.03	0.915
F	0.45	0.60	0.535
G	1.78	2.05	1.83
H	2.80	3.00	2.90
J	0.013	0.10	0.05
K	0.903	1.10	1.00
K1	-	-	0.400
L	0.45	0.61	0.55
M	0.085	0.18	0.11
α	0°	8°	-
All Dimensions in mm			

Suggested Pad Layout

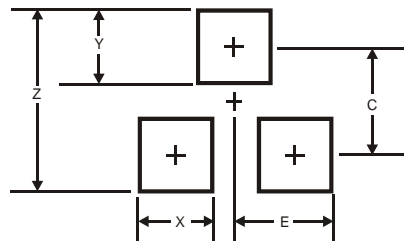

Dimensions	Value (in mm)
Z	2.9
X	0.8
Y	0.9
C	2.0
E	1.35

IMPORTANT NOTICE

Diodes Incorporated and its subsidiaries reserve the right to make modifications, enhancements, improvements, corrections or other changes without further notice to any product herein. Diodes Incorporated does not assume any liability arising out of the application or use of any product described herein; neither does it convey any license under its patent rights, nor the rights of others. The user of products in such applications shall assume all risks of such use and will agree to hold Diodes Incorporated and all the companies whose products are represented on our website, harmless against all damages.

LIFE SUPPORT

Diodes Incorporated products are not authorized for use as critical components in life support devices or systems without the expressed written approval of the President of Diodes Incorporated.