

MMBT2222AT

NPN Epitaxial Silicon Transistor

Features

- General purpose amplifier transistor.
- Ultra-Small Surface Mount Package for all types.
- General purpose switching & amplification application

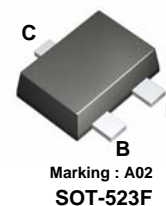

Absolute Maximum Ratings T_a = 25°C unless otherwise noted

Symbol	Parameter	Value	Unit
V _{CBO}	Collector-Base Voltage	75	V
V _{CEO}	Collector-Emitter Voltage	40	V
V _{EBO}	Emitter-Base Voltage	6	V
I _C	Collector Current	600	mA
T _J	Junction Temperature	150	°C
T _{STG}	Storage Temperature Range	-55 ~ 150	°C

- * 1. These ratings are limiting values above which the serviceability of any semiconductor device may be impaired.
2. These are steady state limits. The factory should be consulted on applications involving pulsed or low duty cycle operations.

Thermal Characteristics* T_a = 25°C unless otherwise noted

Symbol	Parameter	Max	Unit
P _C	Collector Power Dissipation, by R _{θJA}	250	mW
R _{θJA}	Thermal Resistance, Junction to Ambient	500	°C/W

* Minimum land pad.

Electrical Characteristics* T_a = 25°C unless otherwise noted

Symbol	Parameter	Test Condition	Min.	Max.	Unit
BV _{CBO}	Collector-Base Breakdown Voltage	I _C = 10μA, I _E = 0	75		V
BV _{CEO}	Collector-Emitter Breakdown Voltage	I _C = 1mA, I _B = 0	40		V
BV _{EBO}	Emitter-Base Breakdown Voltage	I _E = 10μA, I _C = 0	6		V
I _{CEX}	Collector Cut-off Current	V _{CE} = 60V, V _{EB(OFF)} = 3V		10	nA
h _{FE}	DC Current Gain	V _{CE} = 1V, I _C = 0.1mA V _{CE} = 1V, I _C = 1mA V _{CE} = 1V, I _C = 10mA V _{CE} = 1V, I _C = 150mA	35 50 75 100		
V _{CE} (sat)	Collector-Emitter Saturation Voltage	I _C = 150mA, I _B = 15mA I _C = 500mA, I _B = 50mA		0.3 1.0	V V
V _{BE} (sat)	Base-Emitter Saturation Voltage	I _C = 150mA, I _B = 15mA I _C = 500mA, I _B = 50mA	0.6	1.2 2.0	V V
f _T	Current Gain Bandwidth Product	V _{CE} = 20V, I _C = 20mA, f = 100MHz	300		MHz
C _{ob}	Output Capacitance	V _{CB} = 10V, I _E = 0, f = 1MHz		8	pF
C _{ib}	Input Capacitance	V _{EB} = 0.5V, I _C = 0, f = 1MHz		30	pF
t _d	Delay Time	V _{CC} = 30V, I _C = 150mA		10	ns
t _r	Rise Time	I _{B1} = - I _{B2} = 15mA		25	ns
t _s	Storage Time			225	ns
t _f	Fall Time			60	ns

* DC Item are tested by Pulse Test : Pulse Width ≤ 300us, Duty Cycle ≤ 2%

Typical Performance Characteristics

Figure 1. DC Current Gain

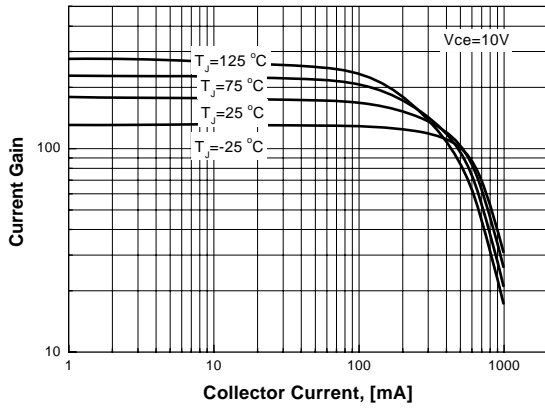

Figure 2. DC Current Gain

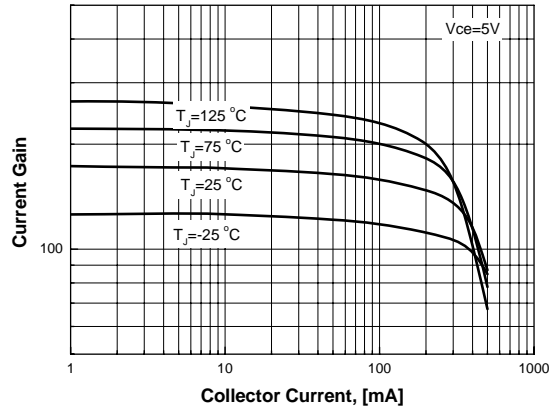

Figure 3. Collector-Emitter Saturation Voltage

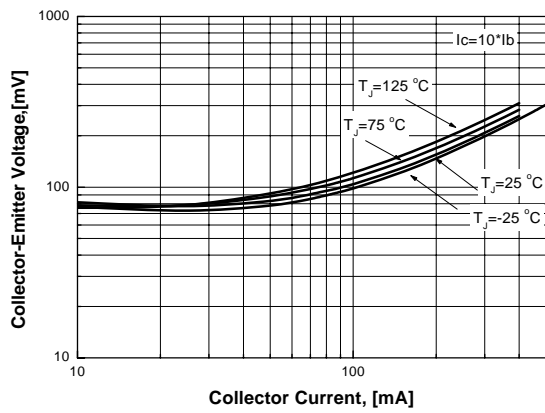

Figure 4. Base-Emitter Saturation voltage

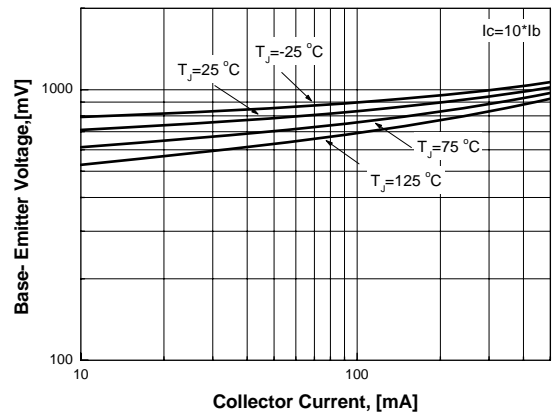

Figure 5. Collector- Base Leakage Current

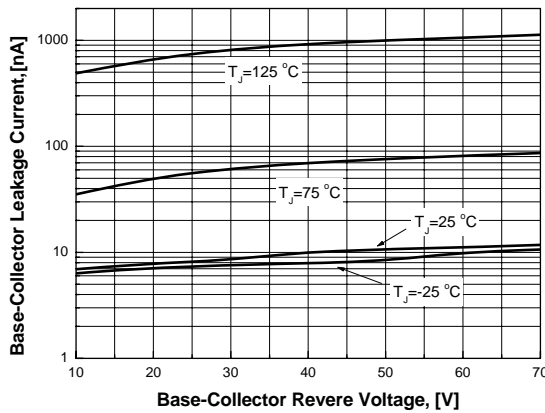
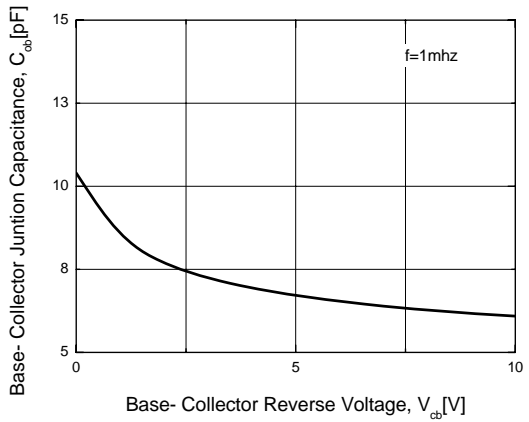
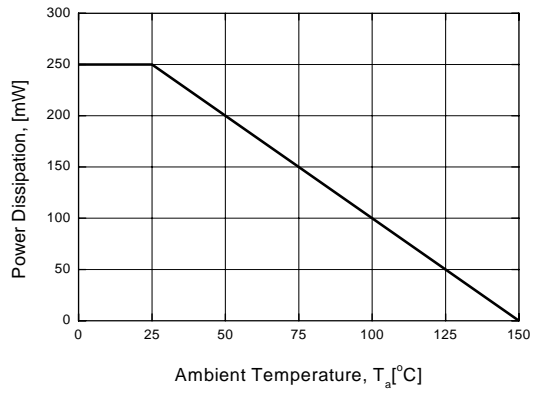

Figure 6. Collector-Base Capacitance



Typical Performance Characteristics

Figure 7. Power Derating



Package Dimensions

SOT-523F

- Case : SOT-523F
- Case Material(Molded Plastic): KTMC1060SC
- UL Flammability classification rating : "V0"
- Moisture Sensivity level per JESD22-A1113B : MSL 1
- Lead terminals solderable per MIL-STD7502026 /JESD22A121
- Lead Free Plating : Pure Tin(Matte)

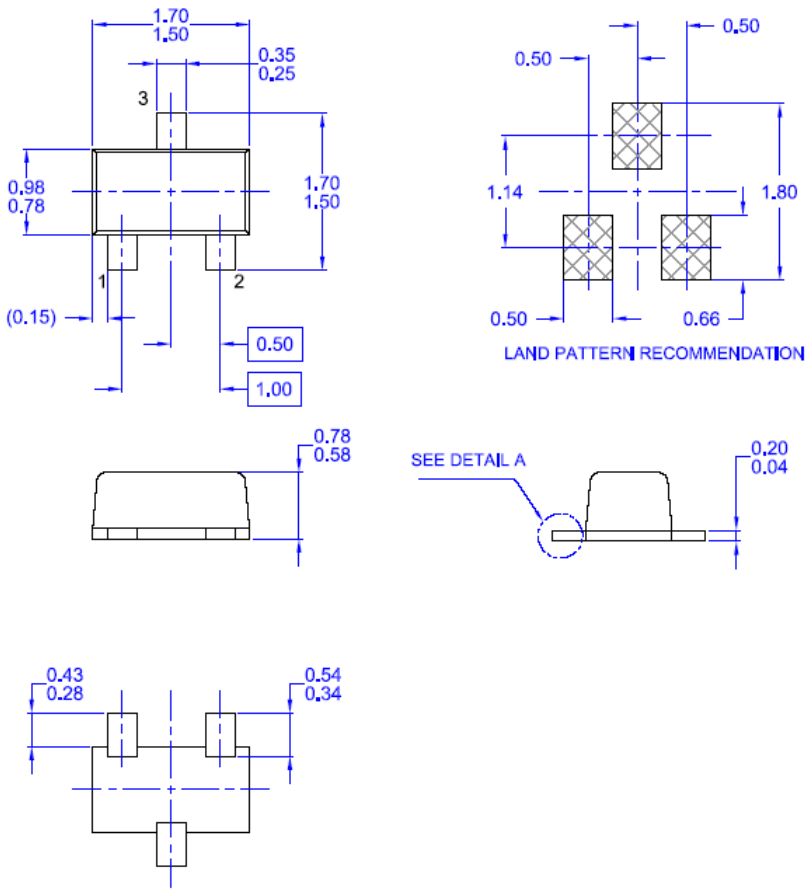

Dimensions in Millimeters



TRADEMARKS

The following are registered and unregistered trademarks and service marks Fairchild Semiconductor owns or is authorized to use and is not intended to be an exhaustive list of all such trademarks.

ACEx [®]	Green FPS [™]	Power247 [®]	SuperSOT [™] -8
Build it Now [™]	Green FPS [™] e-Series [™]	POWEREDGE [®]	SyncFET [™]
CorePLUS [™]	GTO [™]	Power-SPM [™]	The Power Franchise [®]
CROSSVOLT [™]	<i>i-Lo</i> [™]	PowerTrench [®]	the power franchise [®]
CTL [™]	IntelliMAX [™]	Programmable Active Droop [™]	TinyBoost [™]
Current Transfer Logic [™]	ISOPLANAR [™]	QFET [®]	TinyBuck [™]
EcoSPARK [®]	MegaBuck [™]	QS [™]	TinyLogic [®]
F [®]	MICROCOUPLER [™]	QT Optoelectronics [™]	TINYOPTO [™]
Fairchild [®]	MicroFET [™]	Quiet Series [™]	TinyPower [™]
Fairchild Semiconductor [®]	MicroPak [™]	RapidConfigure [™]	TinyPWM [™]
FACT Quiet Series [™]	MillerDrive [™]	SMART START [™]	TinyWire [™]
FACT [®]	Motion-SPM [™]	SPM [®]	μSerDes [™]
FAST [®]	OPTOLOGIC [®]	STEALTH [™]	UHC [®]
FastvCore [™]	OPTOPLANAR [®]	SuperFET [™]	UniFET [™]
FPST [™]	 [®]	SuperSOT [™] -3	VCX [™]
FRFET [®]	PDP-SPM [™]	SuperSOT [™] -6	
Global Power Resource SM	Power220 [®]		

DISCLAIMER

FAIRCHILD SEMICONDUCTOR RESERVES THE RIGHT TO MAKE CHANGES WITHOUT FURTHER NOTICE TO ANY PRODUCTS HEREIN TO IMPROVE RELIABILITY, FUNCTION, OR DESIGN. FAIRCHILD DOES NOT ASSUME ANY LIABILITY ARISING OUT OF THE APPLICATION OR USE OF ANY PRODUCT OR CIRCUIT DESCRIBED HEREIN; NEITHER DOES IT CONVEY ANY LICENSE UNDER ITS PATENT RIGHTS, NOR THE RIGHTS OF OTHERS. THESE SPECIFICATIONS DO NOT EXPAND THE TERMS OF FAIRCHILD'S WORLDWIDE TERMS AND CONDITIONS, SPECIFICALLY THE WARRANTY THEREIN, WHICH COVERS THESE PRODUCTS.

LIFE SUPPORT POLICY

FAIRCHILD'S PRODUCTS ARE NOT AUTHORIZED FOR USE AS CRITICAL COMPONENTS IN LIFE SUPPORT DEVICES OR SYSTEMS WITHOUT THE EXPRESS WRITTEN APPROVAL OF FAIRCHILD SEMICONDUCTOR CORPORATION.

As used herein:

- Life support devices or systems are devices or systems which, (a) are intended for surgical implant into the body, or (b) support or sustain life, and (c) whose failure to perform when properly used in accordance with instructions for use provided in the labeling, can be reasonably expected to result in significant injury to the user.
- A critical component is any component of a life support device or system whose failure to perform can be reasonably expected to cause the failure of the life support device or system, or to affect its safety or effectiveness.

PRODUCT STATUS DEFINITIONS

Definition of Terms

Datasheet Identification	Product Status	Definition
Advance Information	Formative or In Design	This datasheet contains the design specifications for product development. Specifications may change in any manner without notice.
Preliminary	First Production	This datasheet contains preliminary data; supplementary data will be published at a later date. Fairchild Semiconductor reserves the right to make changes at any time without notice to improve design.
No Identification Needed	Full Production	This datasheet contains final specifications. Fairchild Semiconductor reserves the right to make changes at any time without notice to improve design.
Obsolete	Not In Production	This datasheet contains specifications on a product that has been discontinued by Fairchild semiconductor. The datasheet is printed for reference information only.