

Low Noise NPN Transistor Surface Mount

 Lead(Pb)-Free

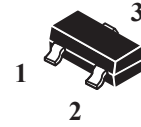
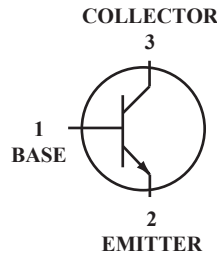

SOT-23

Maximum Ratings

Rating	Symbol	5088LT1	5089LT1	Unit
Collector-Emitter Voltage	V_{CEO}	30	25	Vdc
Collector-Base Voltage	V_{CBO}	35	30	Vdc
Emitter-Base Voltage	V_{EBO}	4.5		Vdc
Collector Current-Continuous	I_C	50		mAdc

Thermal Characteristics

Characteristics	Symbol	Max	Unit
Total Device Dissipation FR-5 Board ⁽¹⁾ $T_A=25^\circ\text{C}$ Derate above 25°C	P_D	225 1.8	mW mW/ $^\circ\text{C}$
Thermal Resistance, Junction to Ambient	$R_{\theta JA}$	556	$^\circ\text{C}/\text{W}$
Total Device Dissipation Alumina Substrate, ⁽²⁾ $T_A=25^\circ\text{C}$ Derate above 25°C	P_D	300 2.4	mW mW/ $^\circ\text{C}$
Thermal Resistance, Junction to Ambient	$R_{\theta JA}$	417	$^\circ\text{C}/\text{W}$
Junction and Storage, Temperature	T_J, T_{stg}	-55 to +150	$^\circ\text{C}$

Device Marking

MMBT5088=1Q ; MMBT5089=1R

Electrical Characteristics ($T_A=25^\circ\text{C}$ Unless Otherwise noted)

Characteristics	Symbol	Min	Max	Unit
-----------------	--------	-----	-----	------

Off Characteristics

Collector-Emitter Breakdown Voltage $I_C = 1.0\text{mA}, I_B = 0$ MMBT5088 $I_C = 1.0\text{mA}, I_B = 0$ MMBT5089	$V_{(BR)CEO}$	30 25	-	V
Collector-Base Breakdown Voltage $I_C = 100\mu\text{A}, I_E = 0$ MMBT5088 $I_C = 100\mu\text{A}, I_E = 0$ MMBT5089	$V_{(BR)CBO}$	35 30	-	V
Collector Cutoff Current $V_{CB} = 20\text{V}, I_E = 0$ MMBT5088 $V_{CB} = 15\text{V}, I_E = 0$ MMBT5089	I_{CBO}	-	50 50	nA
Emitter Cutoff Current $V_{EB}(\text{off}) = 3.0\text{V}, I_C = 0$ MMBT5088 $V_{EB}(\text{off}) = 4.5\text{V}, I_C = 0$ MMBT5089	I_{EBO}	-	50 100	nA

1. FR-5 = 1.0 x 0.75 x 0.062 in.

2. Alumina = 0.4 x 0.3 x 0.024 in. 99.5% alumina.

Electrical Characteristics ($T_A=25^\circ\text{C}$ unless otherwise noted) (Continued)

Characteristics	Symbol	Min	Max	Unit
-----------------	--------	-----	-----	------

On Characteristics

DC Current Gain $V_{CE} = 5.0\text{V}, I_C = 100\mu\text{A}$	MMBT5088 MMBT5089	$h_{FE(1)}$	300 400	900 1200	
$V_{CE} = 5.0\text{V}, I_C = 1.0\text{mA}$	MMBT5088 MMBT5089	$h_{FE(2)}$	350 450	- -	-
$V_{CE} = 5.0\text{V}, I_C = 10\text{mA}$	MMBT5088 MMBT5089	$h_{FE(3)}$	300 400	- -	
Collector-Emitter Saturation Voltage $I_C = 100\text{mA}, I_B = 1.0\text{mA}$		$V_{CE(sat)}$	-	0.5	V
Base-Emitter Saturation Voltage $I_C = 10\text{mA}, I_B = 1.0\text{mA}$		$V_{BE(sat)}$	-	0.8	V

Small-signal Characteristics

Current-Gain-Bandwidth Product $V_{CE} = 5.0\text{V}, I_C = 500\mu\text{A}, f = 20\text{MHz}$		f_T	50	-	MHz
Collector-Base Capacitance $V_{CB} = 5.0\text{V}, I_E = 0, f = 1.0\text{MHz}$ emitter guarded		C_{cb}	-	4.0	pF
Emitter-Base Capacitance $V_{EB} = 0.5\text{V}, I_C = 0, f = 1.0\text{MHz}$ collector guarded		C_{eb}	-	10	pF
Small-Signal Current Gain $V_{CE} = 5.0\text{V}, I_C = 1.0\text{mA}, f = 1.0\text{kHz}$	MMBT5088 MMBT5089	h_{fe}	350 450	1400 1800	-
Noise Figure $V_{CE} = 5.0\text{V}, I_C = 100\mu\text{A}, R_S = 1.0\text{k ohms}, f = 1.0\text{kHz}$	MMBT5088 MMBT5089	NF	-	3.0 2.0	dB

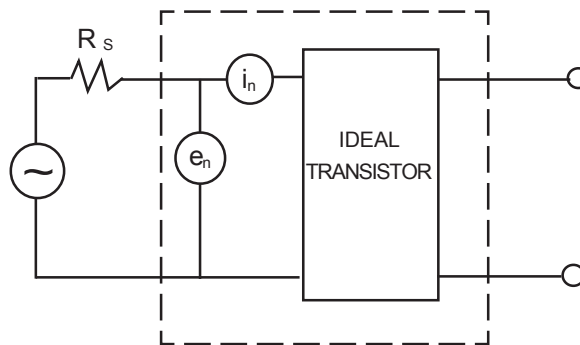

Fig 1. Transistor Noise Model

NOISE CHARACTERISTICS ($V_{CE} = 5.0 \text{ Vdc}$, $T_A = 25^\circ\text{C}$)

NOISE VOLTAGE

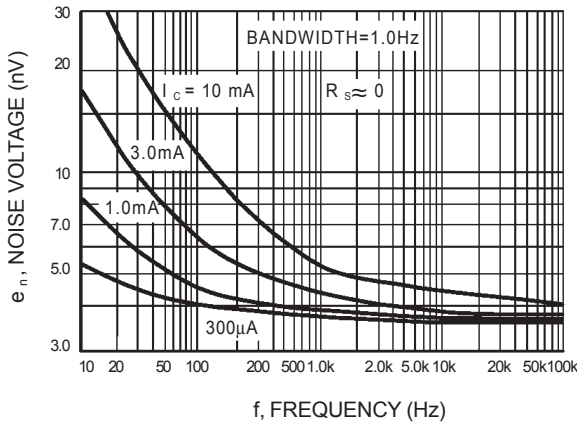

Fig 2. Effects of Frequency

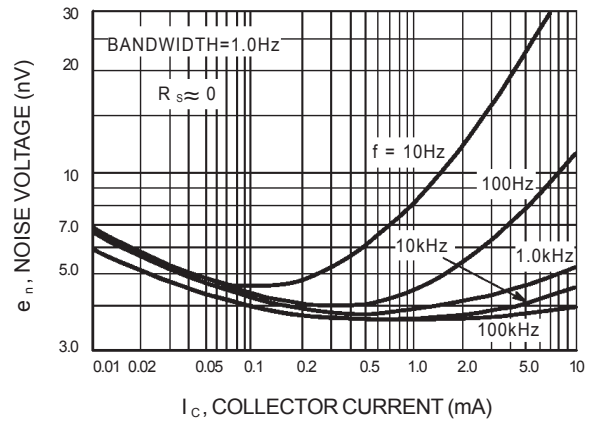

Fig 3. Effects of Collector Current

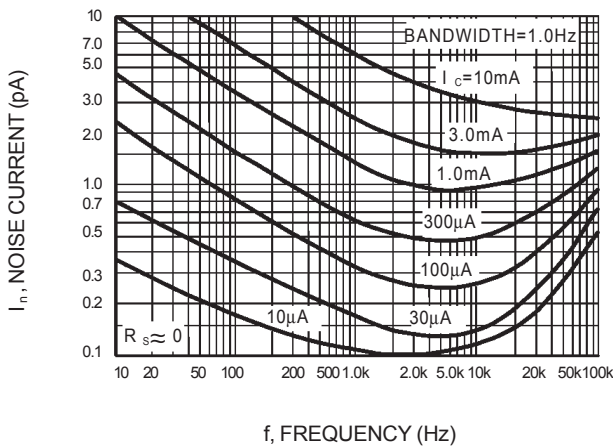

Fig 4. Noise Current

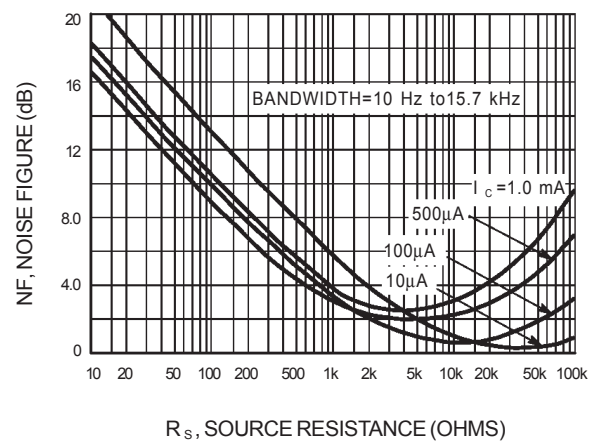

Fig 5. Wideband Noise Figure

100 Hz NOISE DATA

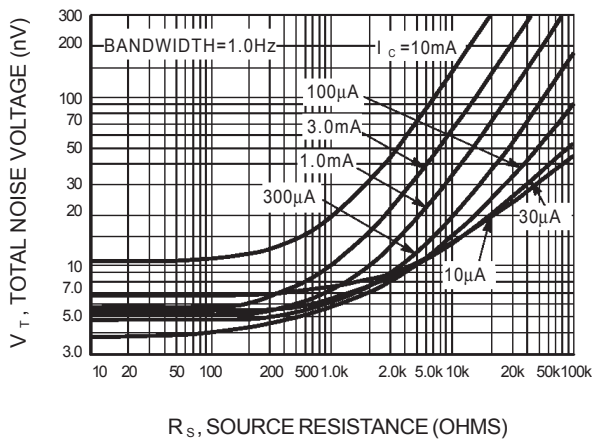

Fig 6. Total Noise Voltage

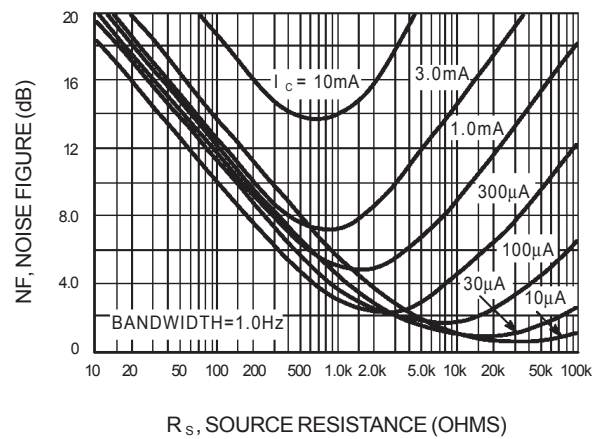

Fig 7. Noise Figure

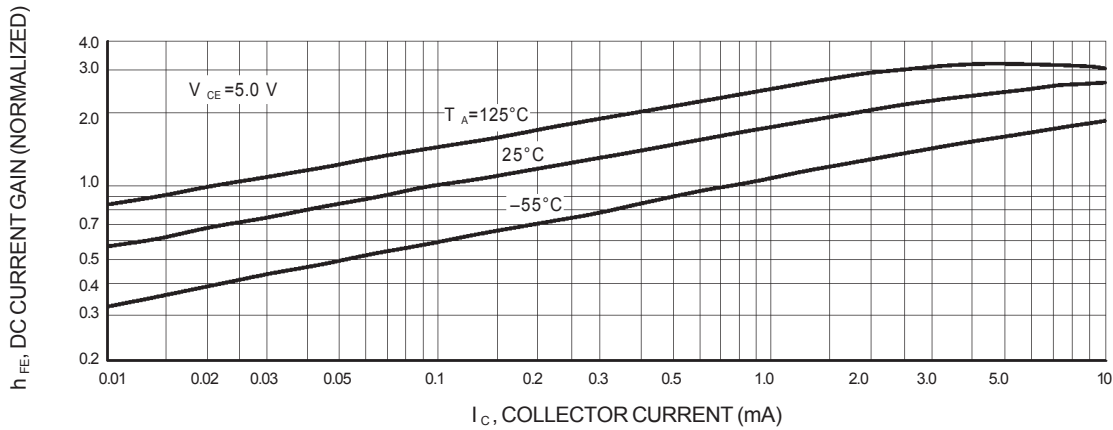

Fig 8. DC Current Gain

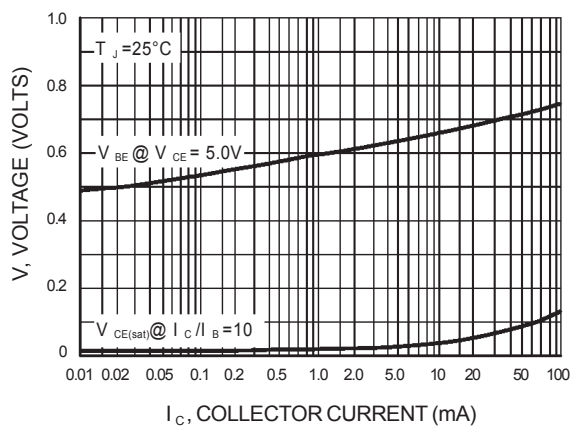

Fig 9. "On" Voltages

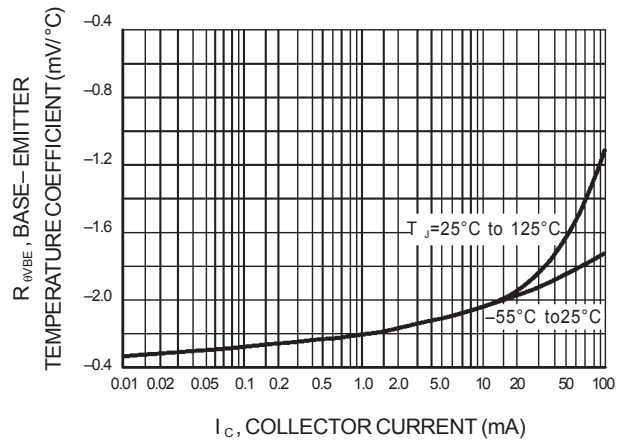

Fig 10. Temperature Coefficients

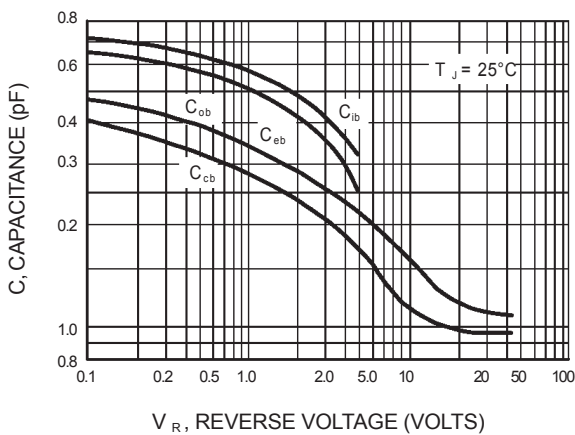

Fig 11. Capacitance

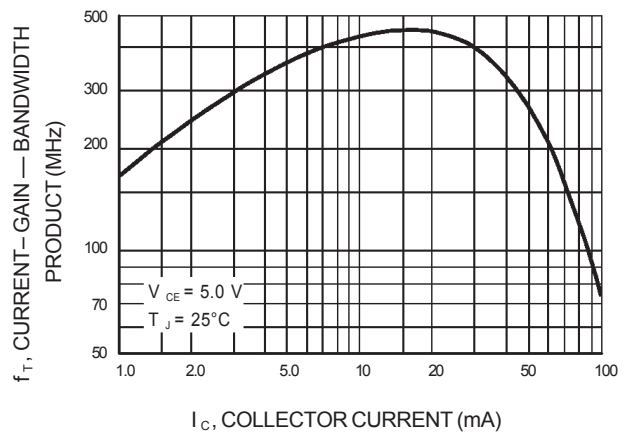
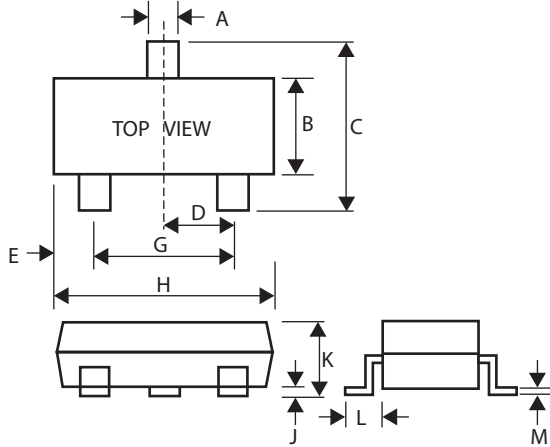

Fig 12. Current-Gain - Bandwidth Product

SOT-23 Package Outline Dimension



SOT-23		
Dim	Min	Max
A	0.35	0.51
B	1.19	1.40
C	2.10	3.00
D	0.85	1.05
E	0.46	1.00
G	1.70	2.10
H	2.70	3.10
J	0.01	0.13
K	0.89	1.10
L	0.30	0.61
M	0.076	0.25