

High Voltage PNP Transistors

 Lead(Pb)-Free

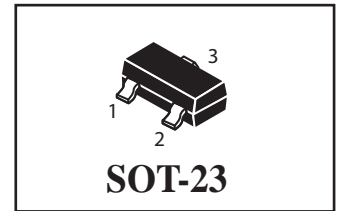
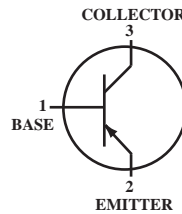

MAXIMUM RATINGS

Rating	Symbol	Value	Unit
Collector-Emitter Voltage	V _{CEO}	-150	Vdc
Collector-Base Voltage	V _{CBO}	-160	Vdc
Emitter-Base Voltage	V _{EBO}	-5.0	Vdc
Collector Current-Continuous	I _C	-500	mAdc

THERMAL CHARACTERISTICS

Characteristics	Symbol	Max	Unit
Total Device Dissipation FR-5 Board (1) T _A =25 °C Derate above 25 °C	P _D	225 1.8	mW mW/°C
Thermal Resistance, Junction to Ambient	R _{θJA}	556	°C/W
Total Device Dissipation Alumina Substrate, (2) T _A =25 °C Derate above 25 °C	P _D	300 2.4	mW mW/°C
Thermal Resistance, Junction to Ambient	R _{θJA}	417	°C/W
Junction and Storage, Temperature	T _J , T _{stg}	-55 to +150	°C

DEVICE MARKING

MMBT5401=2L

ELECTRICAL CHARACTERISTICS (T_A=25 °C unless otherwise noted)

Characteristics	Symbol	Min	Max	Unit
-----------------	--------	-----	-----	------

OFF CHARACTERISTICS

Collector-Emitter Breakdown Voltage (I _C =-1.0 mAdc, I _B =0)	V _{(BR)CEO}	-150	-	Vdc
Collector-Base Breakdown Voltage (I _C =-100 μAdc, I _E =0)	V _{(BR)CBO}	-160	-	Vdc
Emitter-Base Breakdown Voltage (I _E =-10 μAdc, I _C =0)	V _{(BR)EBO}	-5.0	-	Vdc
Collector Cutoff Current (V _{CE} =-120Vdc, I _E =0) (V _{CE} =-120Vdc, I _E =0, T _A =100 °C)	I _{CES}	-	-50	uAdc

1.FR-5=1.0 x 0.75 x 0.062 in.

2.Alumina=0.4 x 0.3 x 0.024 in. 99.5% alumina.

ELECTRICAL CHARACTERISTICS ($T_A=25^{\circ}\text{C}$ unless otherwise noted) (Continued)

Characteristics	Symbol	Min	Max	Unit
-----------------	--------	-----	-----	------

ON CHARACTERISTICS

DC Current Gain ($I_C=-1.0\text{mA}$, $V_{CE}=-5.0\text{V}$) ($I_C=-10\text{mA}$, $V_{CE}=-5.0\text{V}$) ($I_C=-50\text{mA}$, $V_{CE}=-5.0\text{V}$)	h_{FE}	50 60 50	- 240 -	-
Collector-Emitter Saturation Voltage ($I_C=-10\text{mA}$, $I_B=-1.0\text{mA}$) ($I_C=-50\text{mA}$, $I_B=-5.0\text{mA}$)	$V_{CE(sat)}$	-	-0.2 -0.5	Vdc
Base-Emitter Saturation Voltage ($I_C=-10\text{mA}$, $I_B=-1.0\text{mA}$) ($I_C=-50\text{mA}$, $I_B=-5.0\text{mA}$)	$V_{BE(sat)}$	-	-1.0 -1.0	Vdc

SMALL-SIGNAL CHARACTERISTICS

Collector-Gain-Bandwidth Product ($I_C=-10\text{mA}$, $V_{CE}=-10\text{V}$, $f=100\text{MHz}$)	f_T	100	300	MHz
Output Capacitance ($V_{CB}=-10\text{V}$, $I_E=0$, $f=1.0\text{MHz}$)	C_{obo}	-	6.0	pF
Small Signal Current Gain ($I_C=-1.0\text{mA}$, $V_{CE}=-10\text{V}$, $f=1.0\text{kHz}$)	h_{fe}	40	200	-
Noise Figure ($I_C=200\mu\text{A}$, $V_{CE}=-5.0\text{V}$, $R_s=10\Omega$, $f=1.0\text{kHz}$)	NF	-	8.0	dB

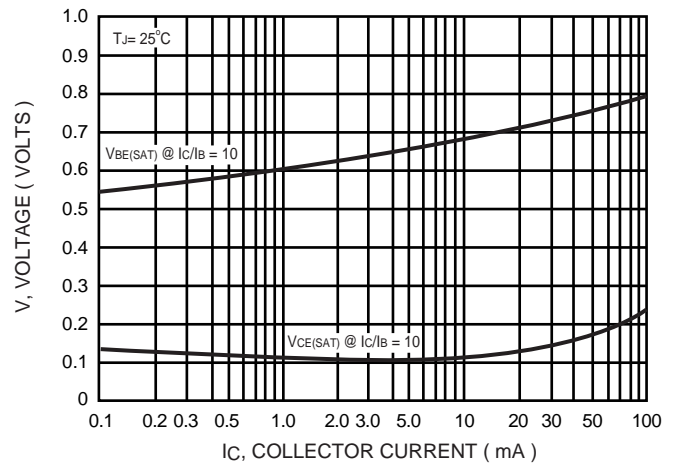
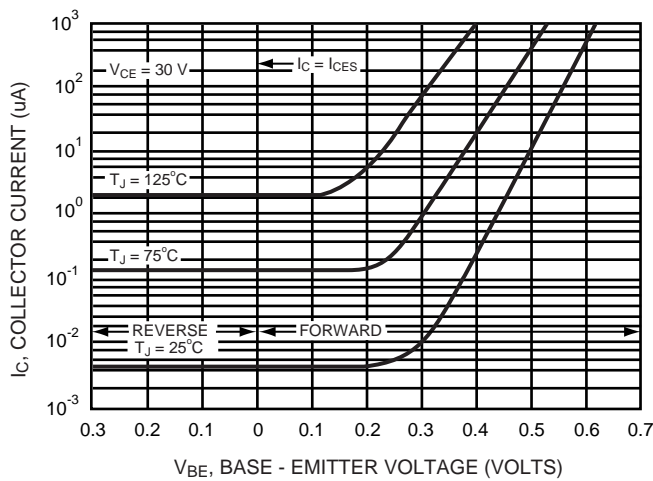
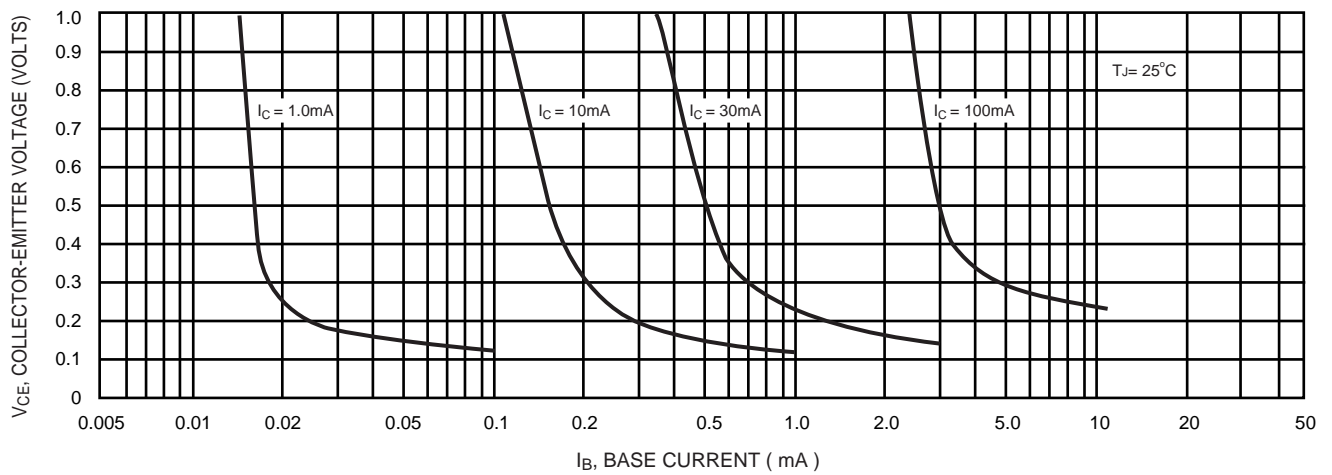
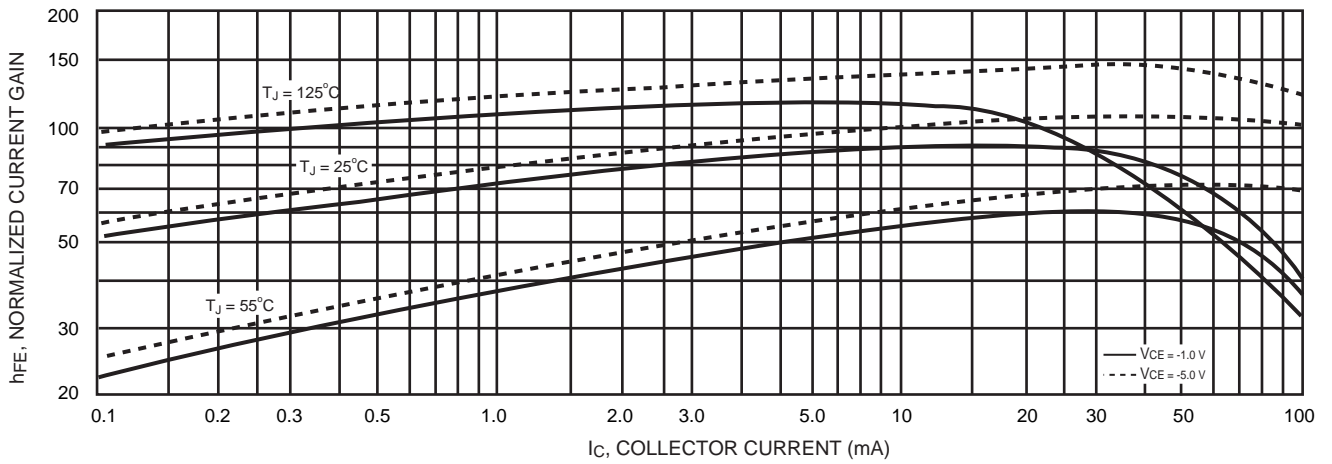

FIG.3 Temperature Coefficients

FIG.4 "On" Voltages

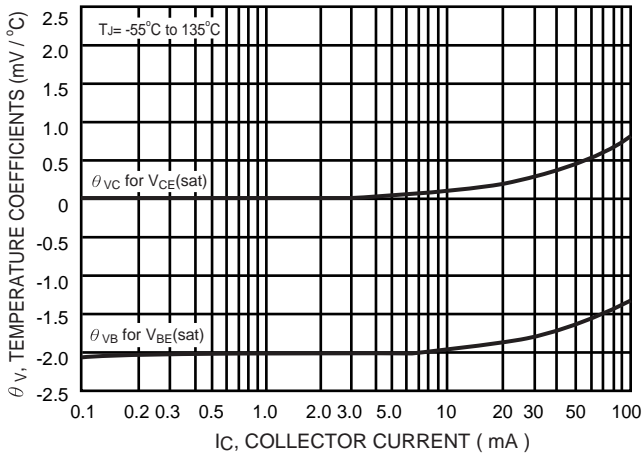
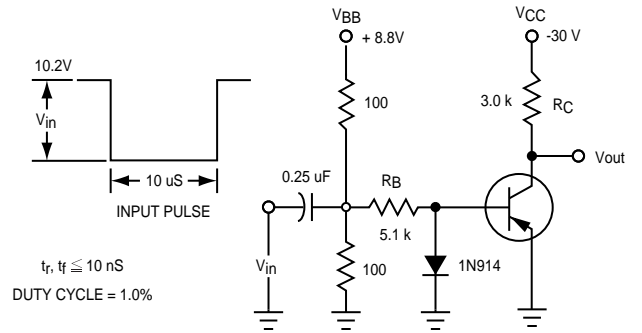

FIG.5 Temperature Coefficients



VALUES SHOWN ARE FOR IC @ 10 mA

FIG.6 Switching Time Test Circuit

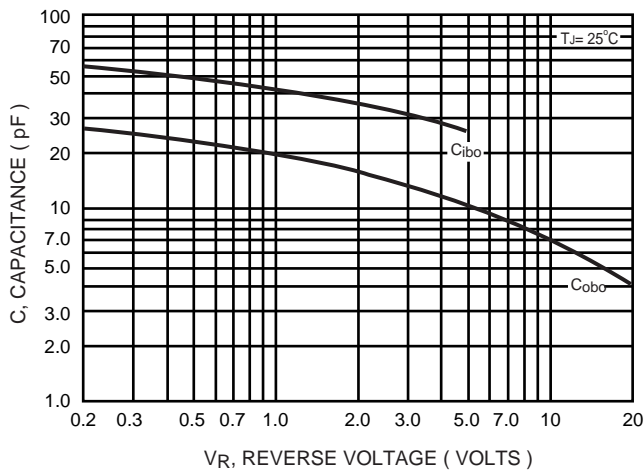

FIG.7 Capacitances

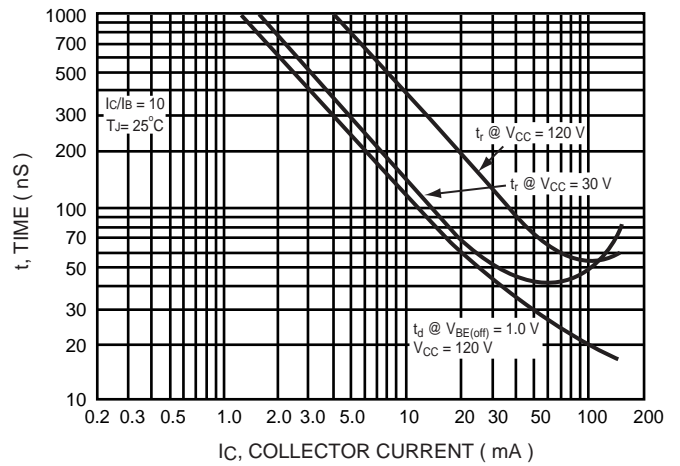

FIG.8 Turn - On Time

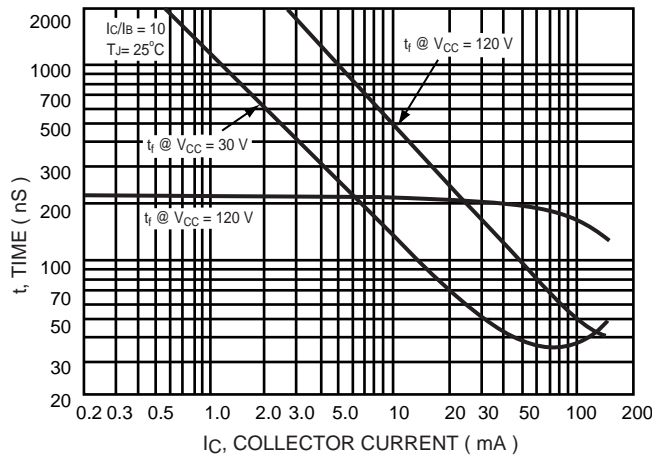
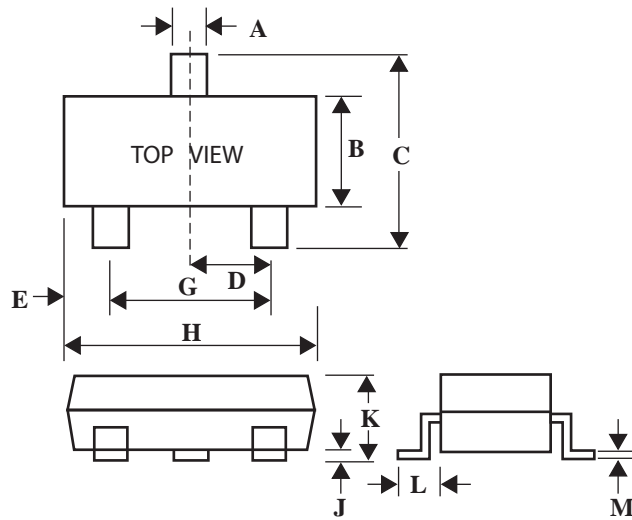

FIG.9 Turn - Off Time

SOT-23 Package Outline Dimensions

Unit:mm



Dim	Min	Max
A	0.35	0.51
B	1.19	1.80
C	2.10	3.00
D	0.85	1.05
E	0.46	1.00
G	1.70	2.10
H	2.70	3.10
J	0.01	0.13
K	0.89	1.60
L	0.30	0.61
M	0.076	0.25