

## PN918

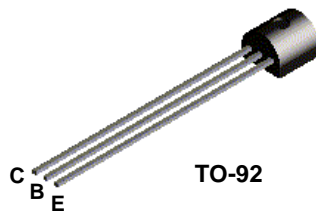

## MMBT918

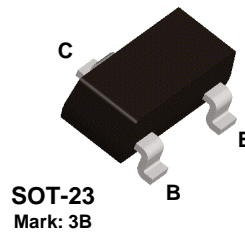

### NPN RF Transistor

This device is designed for use as RF amplifiers, oscillators and multipliers with collector currents in the 1.0 mA to 30 mA range. Sourced from Process 43.

#### Absolute Maximum Ratings\*

TA = 25°C unless otherwise noted

Symbol	Parameter	Value	Units
V <sub>CEO</sub>	Collector-Emitter Voltage	15	V
V <sub>CBO</sub>	Collector-Base Voltage	30	V
V <sub>EBO</sub>	Emitter-Base Voltage	3.0	V
I <sub>C</sub>	Collector Current - Continuous	50	mA
T <sub>J</sub> , T <sub>stg</sub>	Operating and Storage Junction Temperature Range	-55 to +150	°C

\*These ratings are limiting values above which the serviceability of any semiconductor device may be impaired.

#### NOTES:

- 1) These ratings are based on a maximum junction temperature of 150 degrees C.
- 2) These are steady state limits. The factory should be consulted on applications involving pulsed or low duty cycle operations.

#### Thermal Characteristics

TA = 25°C unless otherwise noted

Symbol	Characteristic	Max		Units
		PN918	*MMBT918	
P <sub>D</sub>	Total Device Dissipation	350	225	mW
	Derate above 25°C	2.8	1.8	mW/°C
R <sub>θJC</sub>	Thermal Resistance, Junction to Case	125		°C/W
R <sub>θJA</sub>	Thermal Resistance, Junction to Ambient	357	556	°C/W

\* Device mounted on FR-4 PCB 1.6" X 1.6" X 0.06."

# NPN RF Transistor

(continued)

PN918 / MMBT918

## Electrical Characteristics

TA = 25°C unless otherwise noted

Symbol	Parameter	Test Conditions	Min	Max	Units
--------	-----------	-----------------	-----	-----	-------

### OFF CHARACTERISTICS

$V_{CEO(SUS)}$	Collector-Emitter Sustaining Voltage*	$I_C = 3.0 \text{ mA}, I_B = 0$	15		V
$V_{(BR)CBO}$	Collector-Base Breakdown Voltage	$I_C = 1.0 \mu\text{A}, I_E = 0$	30		V
$V_{(BR)EBO}$	Emitter-Base Breakdown Voltage	$I_E = 10 \mu\text{A}, I_C = 0$	3.0		V
$I_{CBO}$	Collector Cutoff Current	$V_{CB} = 15 \text{ V}, I_E = 0$ $V_{CB} = 15 \text{ V}, T_A = 150^\circ\text{C}$		0.01 1.0	$\mu\text{A}$ $\mu\text{A}$

### ON CHARACTERISTICS

$h_{FE}$	DC Current Gain	$I_C = 3.0 \text{ mA}, V_{CE} = 1.0 \text{ V}$	20		
$V_{CE(sat)}$	Collector-Emitter Saturation Voltage	$I_C = 10 \text{ mA}, I_B = 1.0 \text{ mA}$		0.4	V
$V_{BE(sat)}$	Base-Emitter Saturation Voltage	$I_C = 10 \text{ mA}, I_B = 1.0 \text{ mA}$		1.0	V

### SMALL SIGNAL CHARACTERISTICS

$f_T$	Current Gain - Bandwidth Product	$I_C = 4.0 \text{ mA}, V_{CE} = 10 \text{ V},$ $f = 100 \text{ MHz}$	600		MHz
$C_{obo}$	Output Capacitance	$V_{CB} = 10 \text{ V}, I_E = 0, f = 1.0 \text{ MHz}$ $V_{CB} = 0, I_E = 0, f = 1.0 \text{ MHz}$		1.7 3.0	pF pF
$C_{ibo}$	Input Capacitance	$V_{BE} = 0.5 \text{ V}, I_C = 0, f = 1.0 \text{ MHz}$		2.0	pF
NF	Noise Figure	$I_C = 1.0 \text{ mA}, V_{CE} = 6.0 \text{ V},$ $R_G = 400\Omega, f = 60 \text{ MHz}$		6.0	dB

### FUNCTIONAL TEST

$G_{pe}$	Amplifier Power Gain	$V_{CB} = 12 \text{ V}, I_C = 6.0 \text{ mA},$ $f = 200 \text{ MHz}$	15		dB
$P_O$	Power Output	$V_{CB} = 15 \text{ V}, I_C = 8.0 \text{ mA},$ $f = 500 \text{ MHz}$	30		mW
$\eta$	Collector Efficiency	$V_{CB} = 15 \text{ V}, I_C = 8.0 \text{ mA},$ $f = 500 \text{ MHz}$	25		%

\*Pulse Test: Pulse Width  $\leq 300 \mu\text{s}$ , Duty Cycle  $\leq 2.0\%$

DC Typical Characteristics

Typical Pulsed Current Gain vs Collector Current

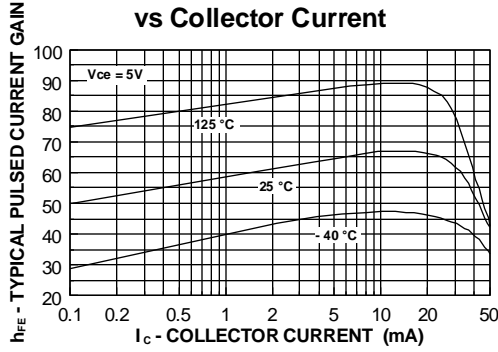

Collector-Emitter Saturation Voltage vs Collector Current

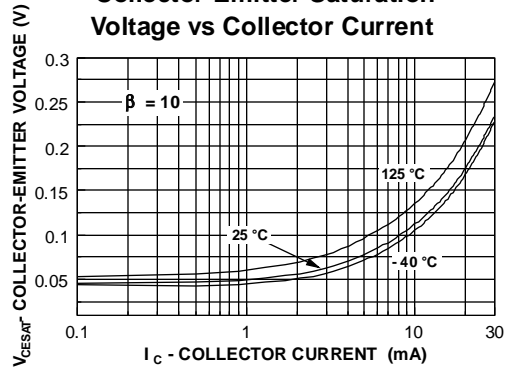

Base-Emitter Saturation Voltage vs Collector Current

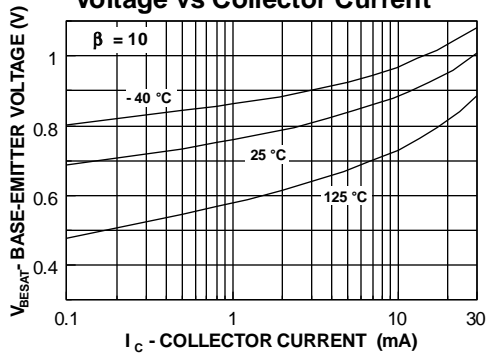

Base-Emitter ON Voltage vs Collector Current

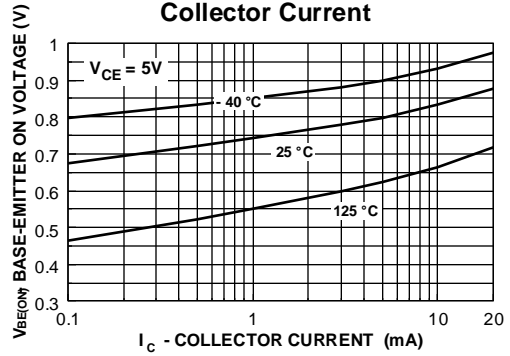

Collector-Cutoff Current vs Ambient Temperature

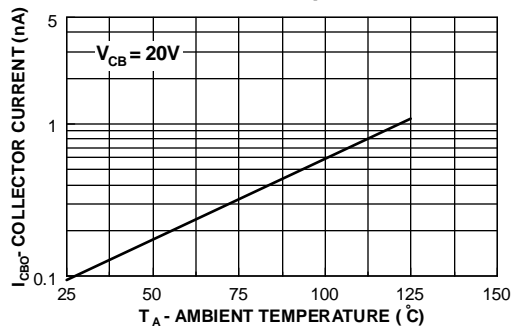

AC Typical Characteristics

Input and Output Capacitance vs Reverse Voltage

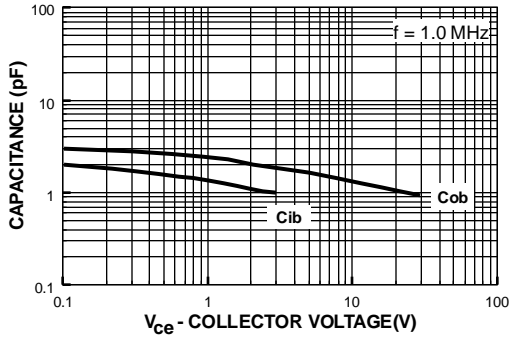

Gain Bandwidth Product vs Collector Current

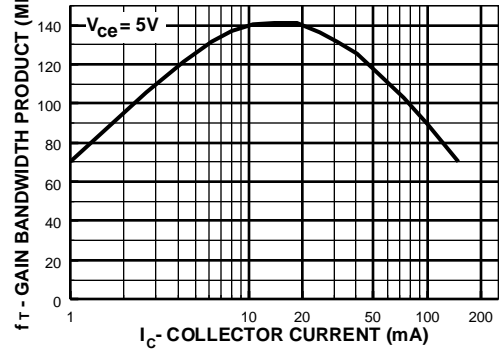

Contours of Constant Gain Bandwidth Product ( $f_T$ )

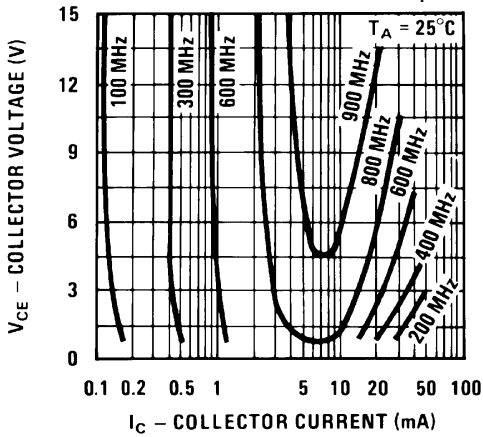

Contours of Constant Noise Figure

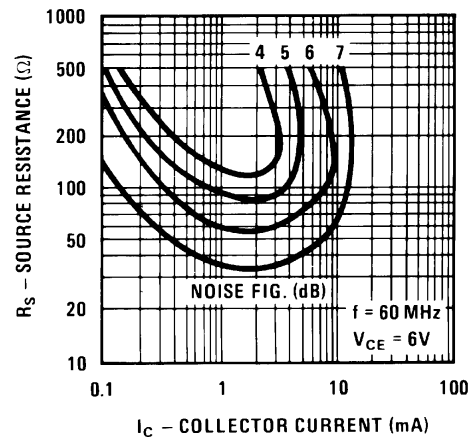

Small Signal Current Gain vs. Collector Current

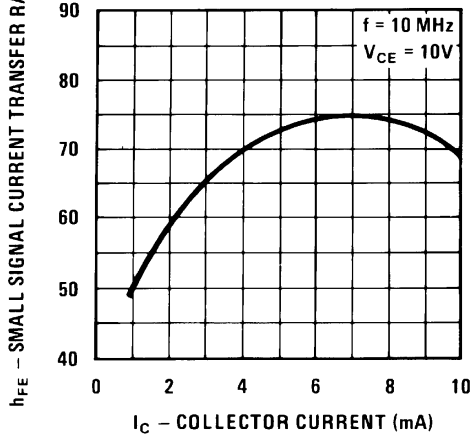

POWER DISSIPATION vs AMBIENT TEMPERATURE

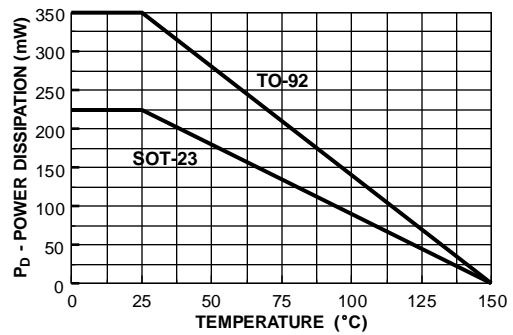

Common Emitter Y Parameters vs. Frequency

Input Admittance vs. Collector Current-Output Short Circuit

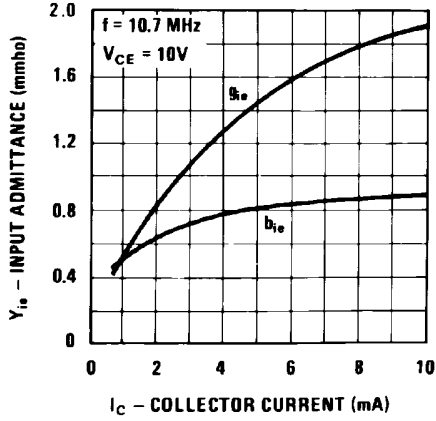

Input Admittance vs. Collector Current-Output Short Circuit

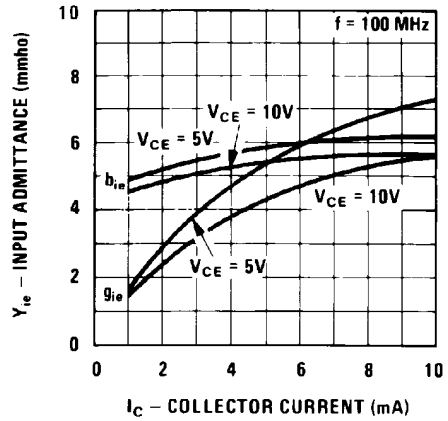

Input Admittance vs. Frequency-Output Short Circuit

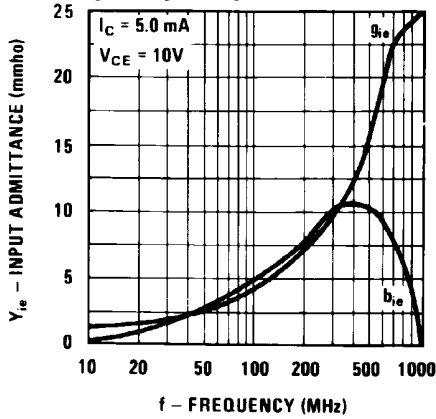

Forward Transfer Admittance vs. Frequency-Output Open Circuit

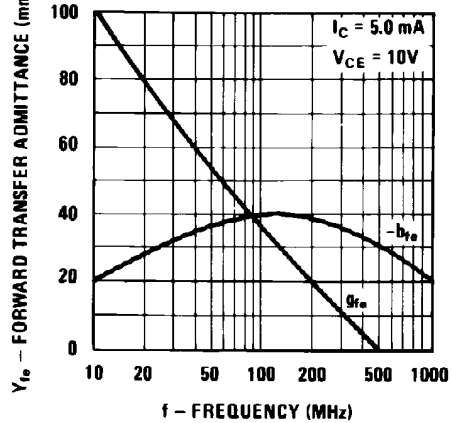

Forward Transfer Admittance vs. Collector Current-Output Short Circuit

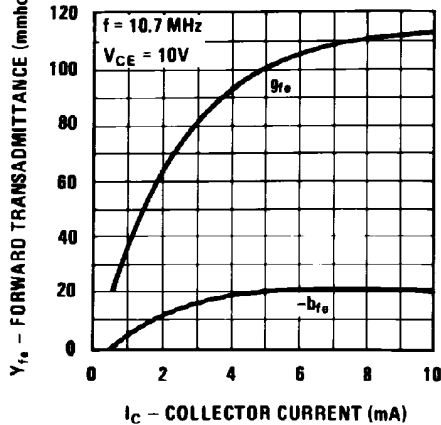

Forward Transfer Admittance vs. Collector Current-Output Short Circuit

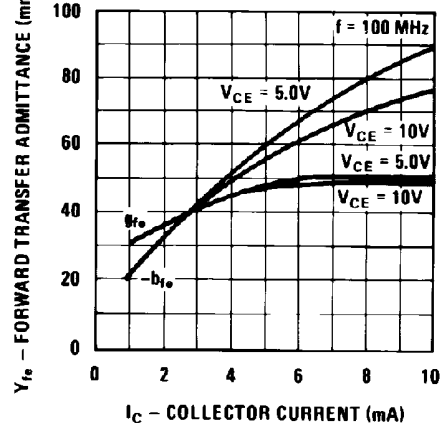

Common Emitter Y Parameters vs. Frequency (continued)

Reverse Transfer Admittance vs. Collector Current-Input Short Circuit

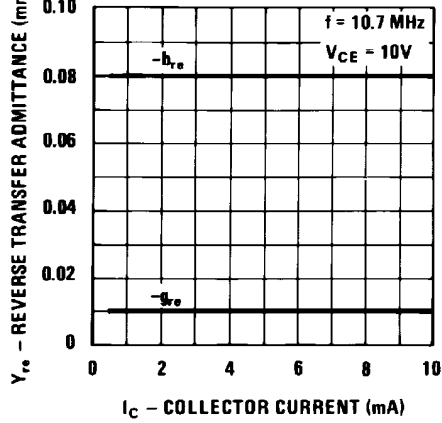

Reverse Transfer Admittance vs. Collector Current-Input Short Circuit

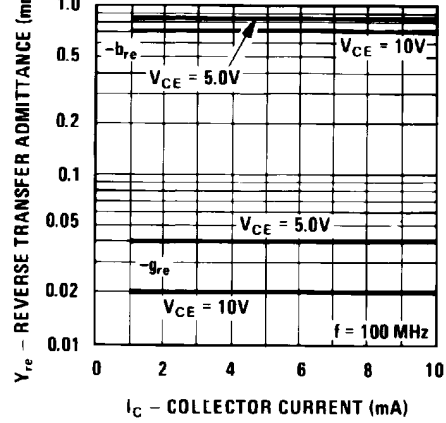

Reverse Transfer Admittance vs. Frequency-Input Short Circuit

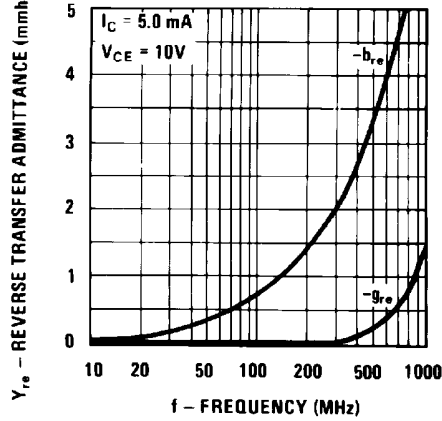

Output Admittance vs. Collector Current-Input Short Circuit

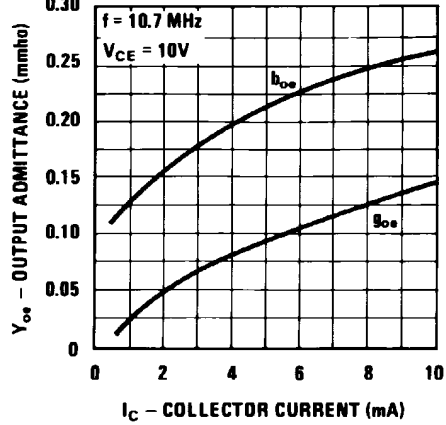

Output Admittance vs. Collector Current-Input Short Circuit

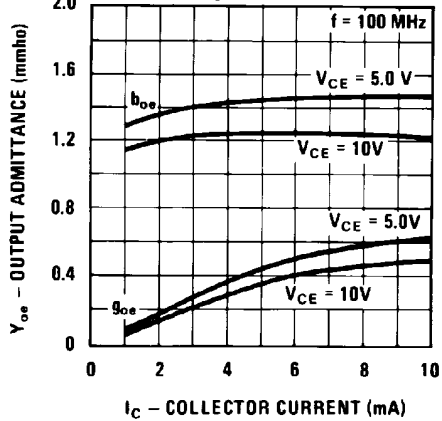

Output Admittance vs. Frequency-Input Short Circuit

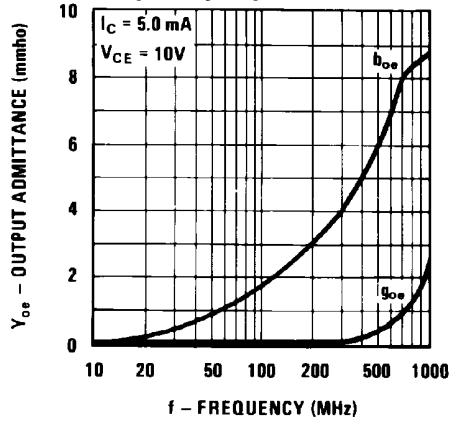

Test Circuit

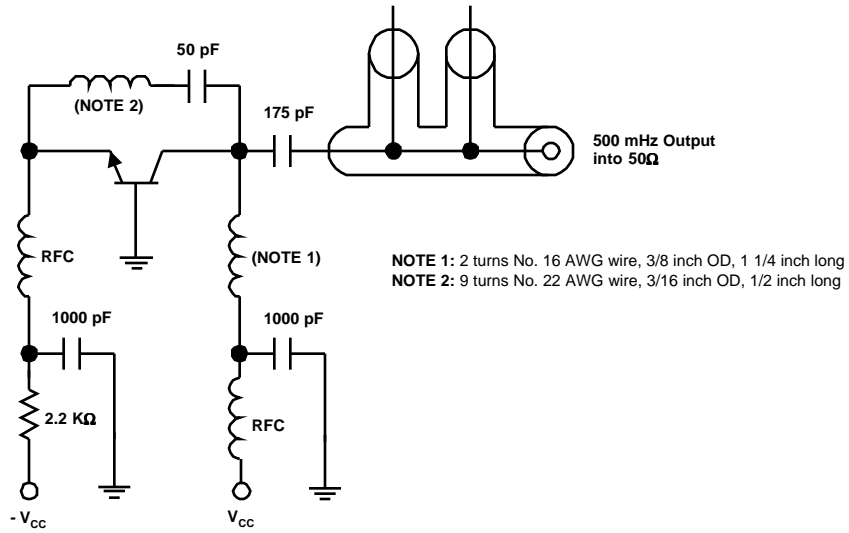

FIGURE 1: 500 MHz Oscillator Circuit