

SOT-23

Features

- ◇ Epitaxial planar die construction
- ◇ Surface device type mounting
- ◇ Moisture sensitivity level 1
- ◇ Driver Transistor
- ◇ Pb free version and RoHS compliant
- ◇ Green compound (Halogen free) with suffix "G" on packing code and prefix "G" on date code

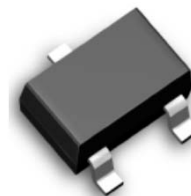

Mechanical Data

- ◇ Case: SOT-23 small outline plastic package per MIL-STD-202, Method 208 guaranteed
- ◇ High temperature soldering guaranteed: 260°C/10s
- ◇ Weight: 7.888mg

SOT-23

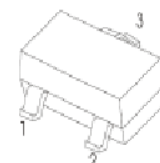

1. BASE
 2. EMITTER
 3. COLLECTOR

Ordering Information (example)

Part No.	Package	Packing	Packing code	Packing code (Green)	Marking	Manufacture code
MMBTA05	SOT-23	3K / 7" Reel	RU	RUG	1H	M0

Note : Detail please see "Ordering Information(detail, example)" below.

Maximum Ratings and Electrical Characteristics

Absolute Maximum Ratings (T_A=25°C)

Parameter	Symbol	Value	Units
Collector Base Voltage	V _{CB0}	60	V
Collector Emitter Voltage	V _{CEO}	60	V
Emitter Base Voltage	V _{EBO}	4	V
Collector Current- Continuous	I _C	0.5	A
Collector Power Dissipation	P _C	300	mW
Junction Temperature	T _J	150	°C
Storage Temperature Range	T _{STG}	- 55 to + 150	°C

Characteristics at T_A=25°C

Parameter	Symbol	Min.	Typ.	Max.	Units
Collector Base Breakdown Voltage at I _C =100uA, I _E =0	V _{(BR)CBO}	60	-	-	V
Collector Emitter Breakdown Voltage at I _C =1mA, I _B =0	V _{(BR)CEO}	60	-	-	V
Emitter Base Breakdown Voltage at I _E =100uA, I _C =0	V _{(BR)EBO}	4	-	-	V
Collector Cutoff Current at V _{CB} =60V, I _E =0	I _{CBO}	-	-	0.1	uA
Collector Cutoff Current at V _{CE} =60V, I _B =0	I _{CEO}	-	-	0.1	uA
Emitter Cutoff Current at V _{EB} =3V, I _C =0	I _{EBO}	-	-	0.1	uA
DC Current Gain at V _{CE} =1V, I _C =10mA	h _{FE}	100	-	400	
	h _{FE}	100	-	-	
Collector Emitter Saturation Voltage at I _C =50mA, I _B =5mA	V _{CE(sat)}	-	-	0.25	V
Base-emitter Voltage at V _{CE} =1V, I _C =100mA	V _{BE}	-	-	1.2	V
Transition Frequency at V _{CE} =2V, I _C =10mA, f=100MHz	f _T	100	-	-	MHz

Small Signal Product

FIG.1 Static Characteristic

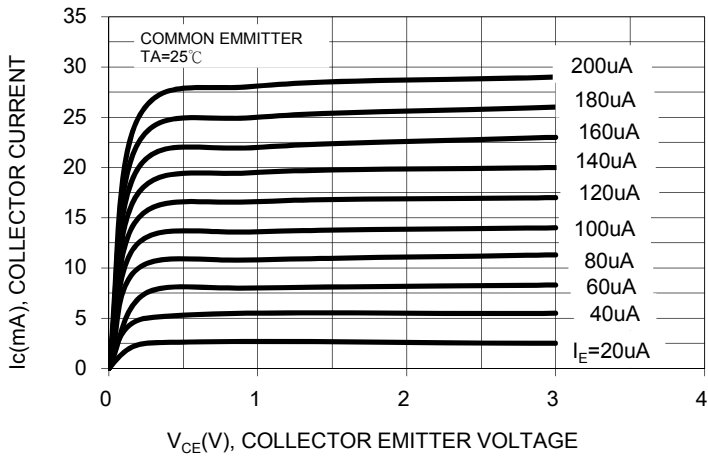

FIG. 2 $h_{FE} - I_C$

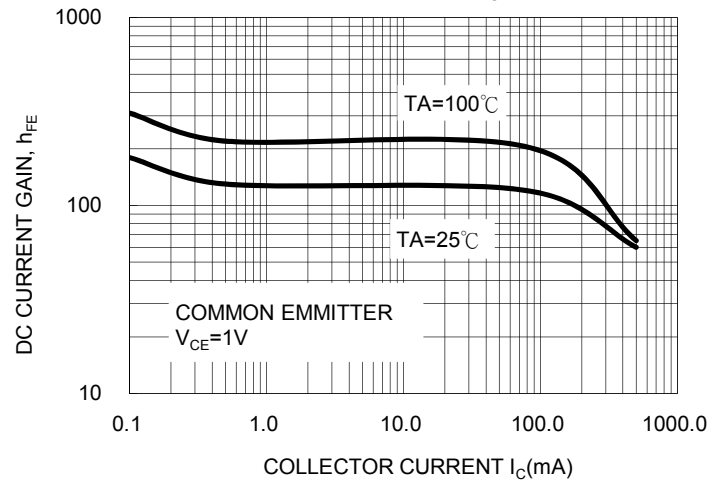

FIG. 3 $V_{BE(sat)} - I_C$

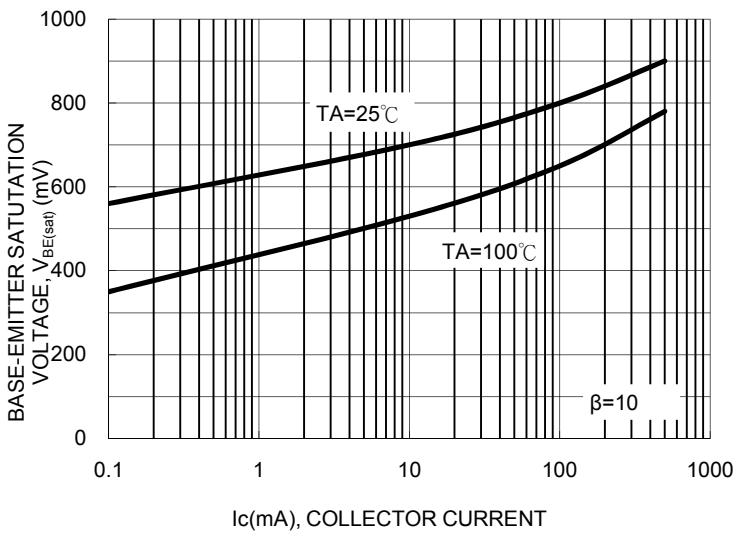

FIG. 4 $V_{CE(sat)} - I_C$

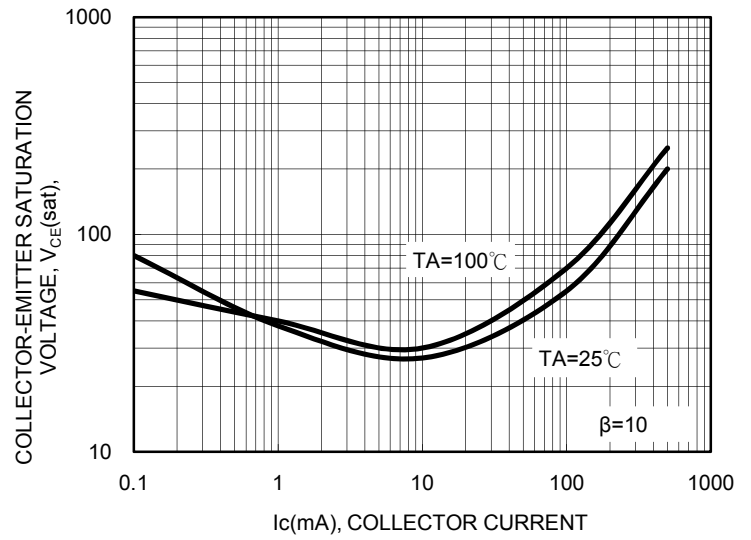

FIG. 5 $I_C - V_{BE}$

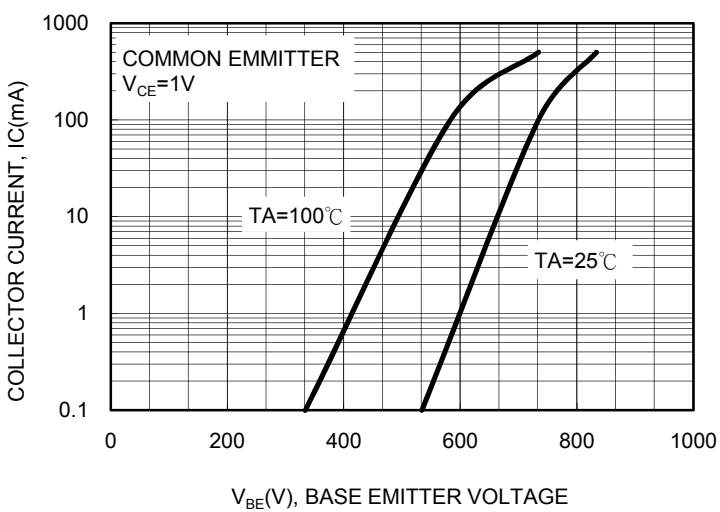
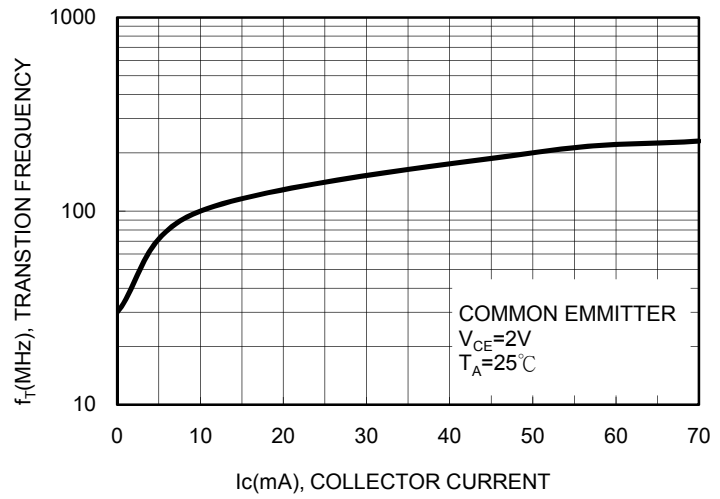

FIG. 6 $f_T - I_C$



Small Signal Product

FIG. 7 Cob/Cib - V_{CB}/V_{EB}

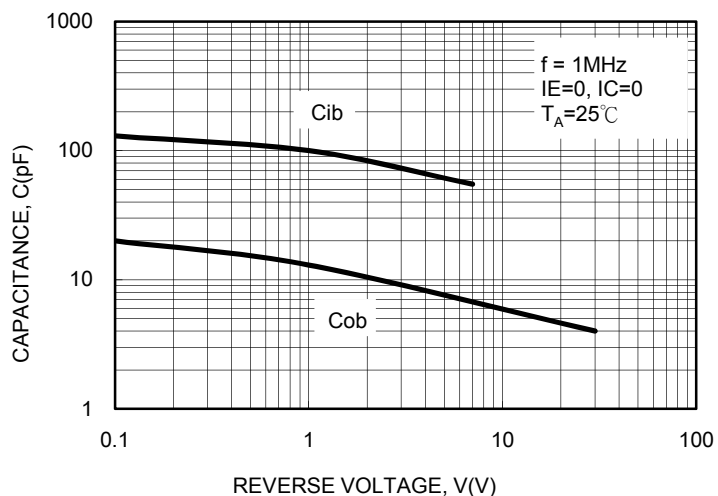
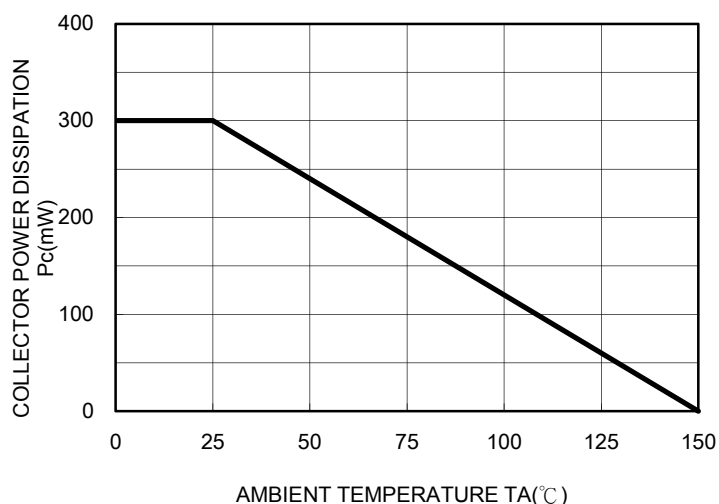

FIG. 8 $P_C - T_A$



Ordering information (Detail, example)

Part No.	Package	Packing	Packing code	Packing code (Green)	Marking	Manufacture code
MMBTA05	SOT-23	3K / 7" Reel	RU	RUG	1H	(Note)
MMBTA05	SOT-23	3K / 7" Reel	RU	RUG	1H	
MMBTA05	SOT-23	3K / 7" Reel	RU	RUG	1H	M0

Note : Manufacture special control, if empty means no special control requirement.

Tape and Reel specification

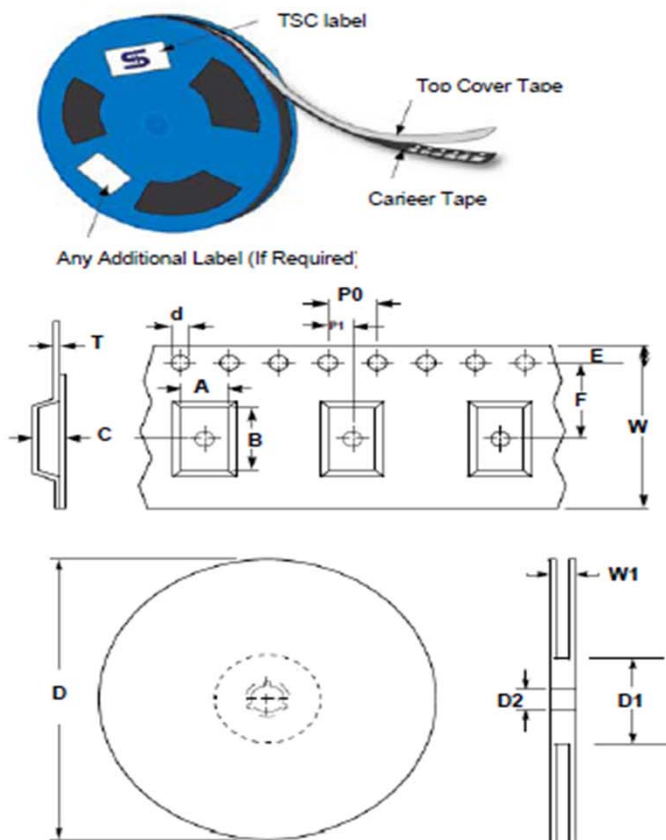

Item	Symbol	Dimension(mm)
Carrier width	A	3.15 ±0.10
Carrier length	B	2.77 ±0.10
Carrier depth	C	1.22 ±0.10
Sprocket hole	d	1.50 ± 0.10
Reel outside diameter	D	178 ± 1
Reel inner diameter	D1	55 Min
Feed hole width	D2	13.0 ± 0.20
Sprocket hole position	E	1.75 ±0.10
Punch hole position	F	3.50 ±0.05
Sprocket hole pitch	P0	4.00 ±0.10
Embossment center	P1	2.00 ±0.05
Overall tape thickness	T	0.229 ±0.013
Tape width	W	8.10 ±0.20
Reel width	W1	12.30 ±0.20

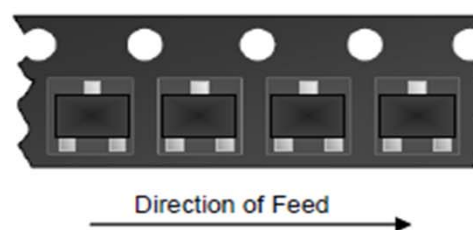

Small Signal Product

Dimensions

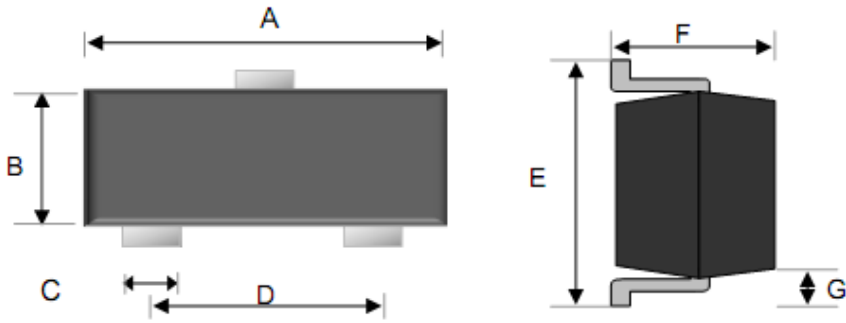

DIM.	Unit(mm)		Unit(inch)	
	Min	Max	Min	Max
A	2.80	3.04	0.110	0.120
B	1.20	1.40	0.047	0.055
C	0.30	0.51	0.012	0.020
D	1.78	2.04	0.070	0.080
E	2.25	2.55	0.089	0.100
F	0.89	1.20	0.035	0.047
G	0.55 REF		0.022 REF	

Suggested PAD Layout

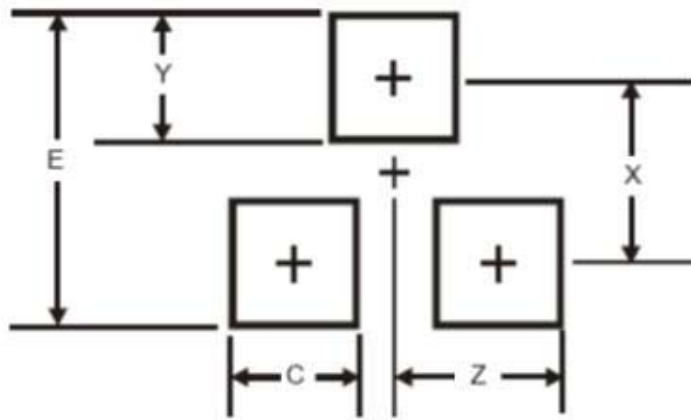

Symbol	Unit(mm)
Z	1.35
X	2.0
Y	0.9
C	0.8
E	2.9