

RoHS Compliant Product

A suffix of "-C" specifies halogen & lead-free

SOT-23		
Dim	Min	Max
A	2.800	3.040
B	1.200	1.400
C	0.890	1.110
D	0.370	0.500
G	1.780	2.040
H	0.013	0.100
J	0.085	0.177
K	0.450	0.600
L	0.890	1.020
S	2.100	2.500
V	0.450	0.600
All Dimension in mm		

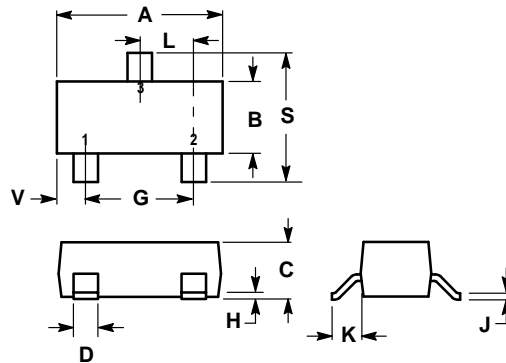
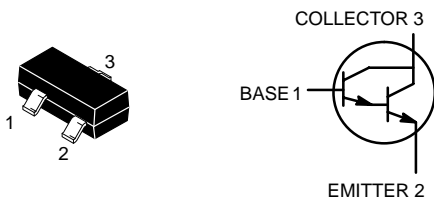

FEATURES

Power dissipation

$P_{CM} : 0.3W (T_{amb}=25^{\circ}C)$

Collector current

$I_{CM} : 0.3A$

Collector-base voltage

$V_{(BR)CBO} : 30V$

Operating and storage junction temperature range

$T_J, T_{stg} : -55^{\circ}C \text{ to } +150$

ELECTRICAL CHARACTERISTICS ($T_{amb}=25^{\circ}C$ unless otherwise specified)

Parameter	Symbol	Test conditions	MIN	MAX	UNIT
Collector-base breakdown voltage	$V_{(BR)CBO}$	$I_C=100 \mu A, I_E=0$	30		V
Collector-emitter breakdown voltage	$V_{(BR)CEO}$	$I_C=100 \mu A, I_B=0$	30		V
Collector-emitter breakdown voltage	$V_{(BR)EBO}$	$I_E=100 \mu A, I_C=0$	10		V
Collector cut-off current	I_{CBO}	$V_{CB}=30V, I_E=0$		0.1	μA
Emitter cut-off current	I_{EBO}	$V_{EB}=10V, I_C=0$		0.1	μA
DC current gain	$h_{FE(1)}$ *	$V_{CE}=5V, I_C=10mA$	MMBTA13 5000		
	$h_{FE(2)}$ *	$V_{CE}=5V, I_C=100mA$	MMBTA13 10000 MMBTA14 20000		
Collector-emitter saturation voltage	$V_{CE(sat)}$ *	$I_C=100mA, I_B=0.1mA$		1.5	V
Base-emitter voltage	V_{BE} *	$V_{CE}=5V, I_C=100mA$		2.0	V
Transition frequency	f_T	$V_{CE}=5V, I_C=10mA$ $f=100MHz$	125		MHz

* Pulse Test : pulse width $\leq 300 \mu s$, duty cycle $\leq 2\%$.

Marking : MMBTA13:K2D; MMBTA14: K3D

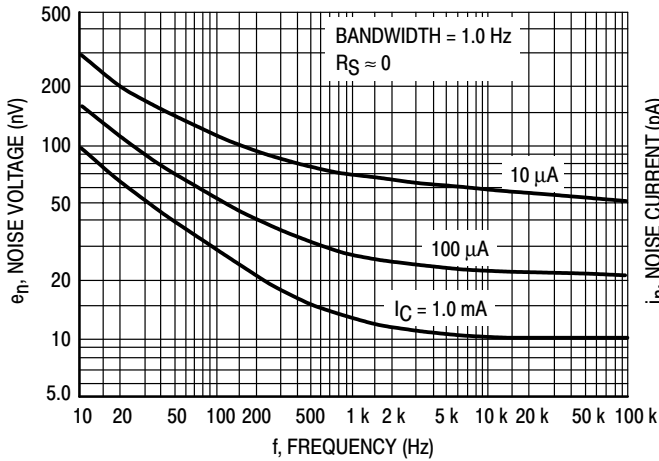

Figure 1. Noise Voltage

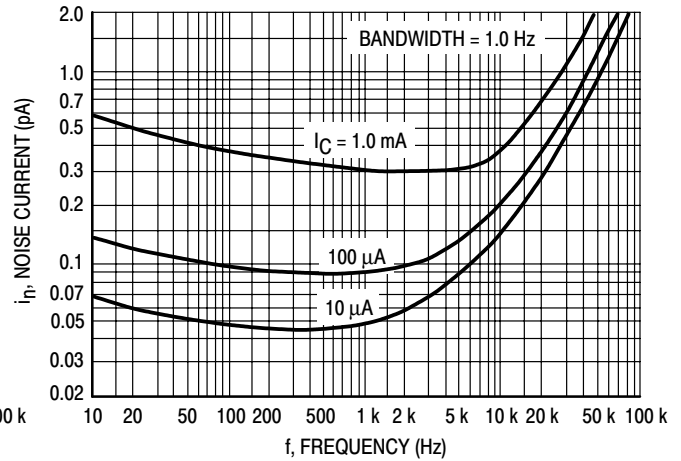

Figure 2. Noise Current

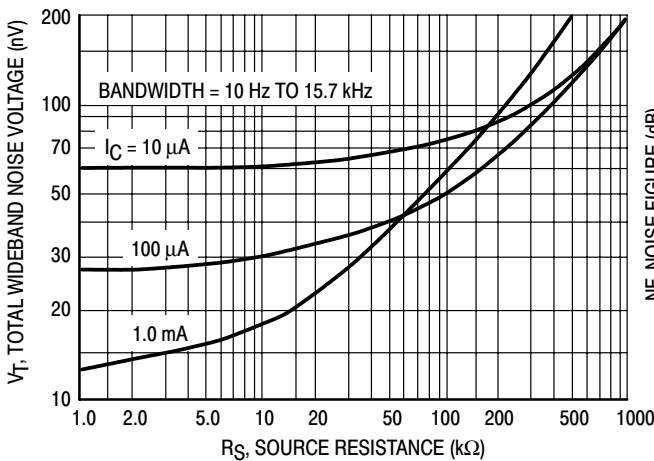

Figure 3. Total Wideband Noise Voltage

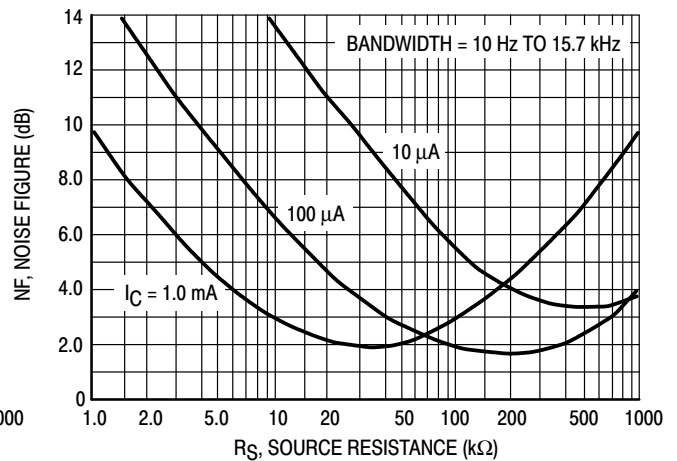

Figure 4. Wideband Noise Figure

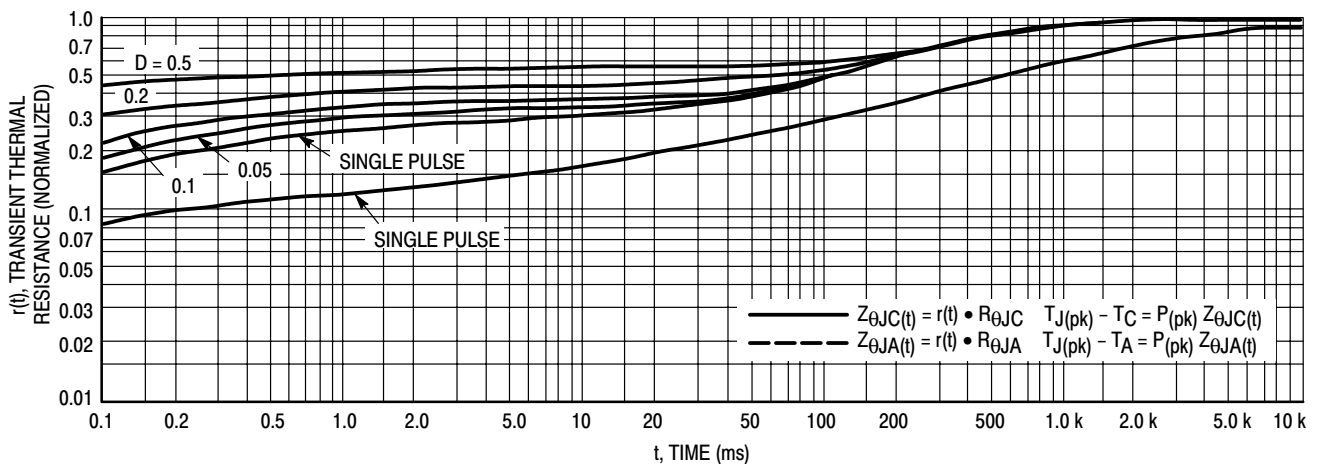

Figure 5. Thermal Response

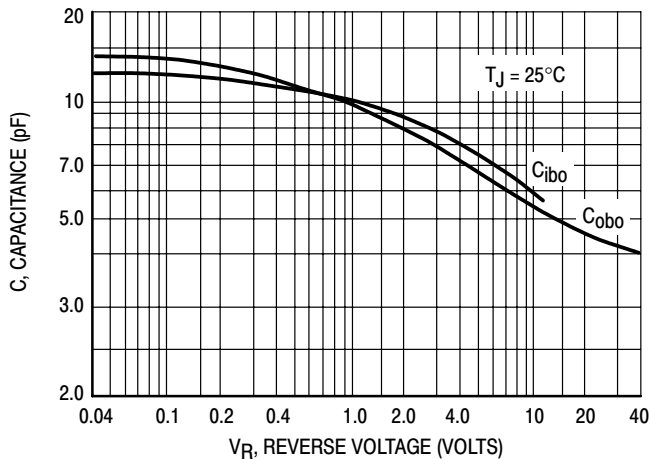

Figure 6. Capacitance

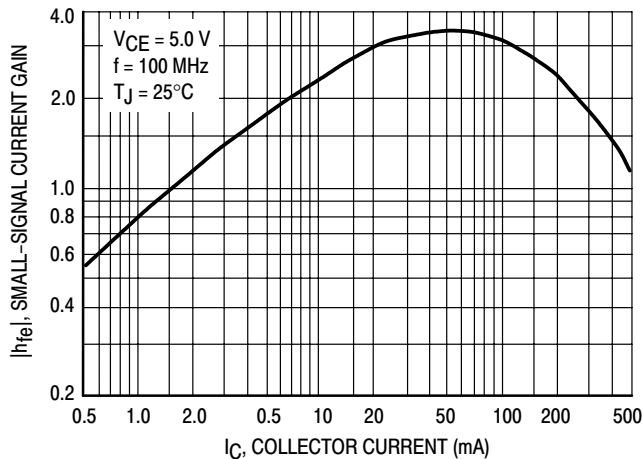

Figure 7. High Frequency Current Gain

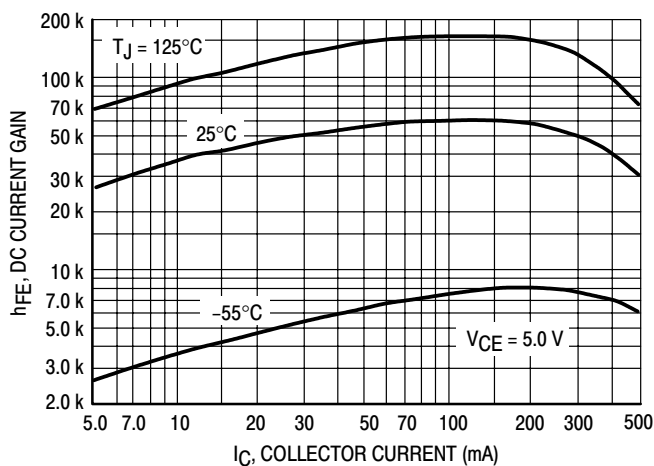

Figure 8. DC Current Gain

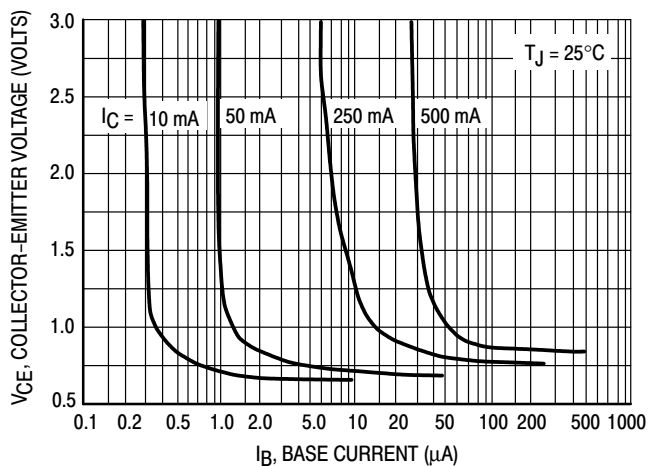

Figure 9. Collector Saturation Region

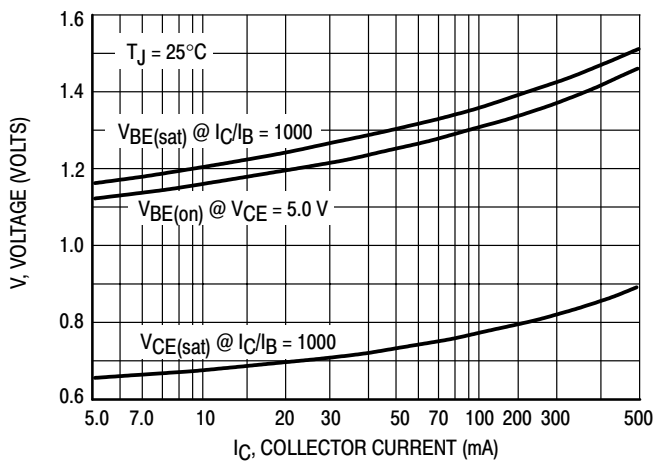

Figure 10. "On" Voltages

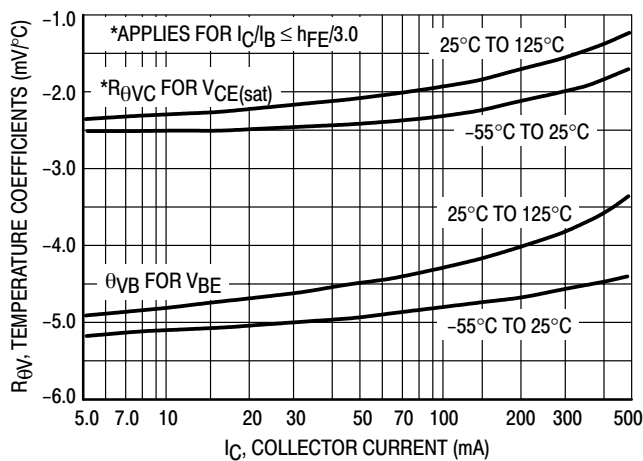

Figure 11. Temperature Coefficients