

MMBTA20LT1

General Purpose Amplifier

NPN Silicon

Features

- Pb-Free Package is Available

MAXIMUM RATINGS

Rating	Symbol	Value	Unit
Collector-Emitter Voltage	V_{CEO}	40	Vdc
Emitter-Base Voltage	V_{EBO}	4.0	Vdc
Collector Current - Continuous	I_C	100	mAdc

THERMAL CHARACTERISTICS

Characteristic	Symbol	Max	Unit
Total Device Dissipation FR-5 Board, (Note 1) $T_A = 25^\circ\text{C}$ Derate above 25°C	P_D	225 1.8	mW mW/ $^\circ\text{C}$
Thermal Resistance, Junction-to-Ambient	$R_{\theta JA}$	556	$^\circ\text{C}/\text{W}$
Total Device Dissipation Alumina Substrate, (Note 2) $T_A = 25^\circ\text{C}$ Derate above 25°C	P_D	300 2.4	mW mW/ $^\circ\text{C}$
Thermal Resistance, Junction-to-Ambient	$R_{\theta JA}$	417	$^\circ\text{C}/\text{W}$
Junction and Storage Temperature	T_J, T_{stg}	-55 to +150	$^\circ\text{C}$

Maximum ratings are those values beyond which device damage can occur. Maximum ratings applied to the device are individual stress limit values (not normal operating conditions) and are not valid simultaneously. If these limits are exceeded, device functional operation is not implied, damage may occur and reliability may be affected.

- FR-5 = $1.0 \times 0.75 \times 0.062$ in.
- Alumina = $0.4 \times 0.3 \times 0.024$ in. 99.5% alumina.



ON Semiconductor®

<http://onsemi.com>

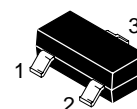
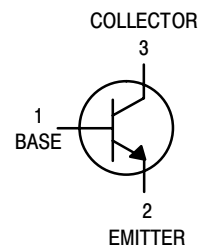

SOT-23 (TO-236)
CASE 318
STYLE 6

MARKING DIAGRAM

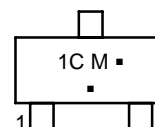

1C = Specific Device Code

M = Date Code*

■ = Pb-Free Package

(Note: Microdot may be in either location)

*Date Code orientation and/or overbar may vary depending upon manufacturing location.

ORDERING INFORMATION

Device	Package	Shipping†
MMBTA20LT1	SOT-23	3,000 / Tape & Reel
MMBTA20LT1G	SOT-23 (Pb-Free)	3,000 / Tape & Reel

†For information on tape and reel specifications, including part orientation and tape sizes, please refer to our Tape and Reel Packaging Specifications Brochure, BRD8011/D.

MMBTA20LT1

ELECTRICAL CHARACTERISTICS ($T_A = 25^\circ\text{C}$ unless otherwise noted)

Characteristic	Symbol	Min	Max	Unit
OFF CHARACTERISTICS				
Collector–Emitter Breakdown Voltage ($I_C = 1.0\text{ mA}$, $I_B = 0$)	$V_{(BR)CEO}$	40	–	Vdc
Emitter–Base Breakdown Voltage ($I_E = 100\ \mu\text{A}$, $I_C = 0$)	$V_{(BR)EBO}$	4.0	–	Vdc
Collector Cutoff Current ($V_{CB} = 30\text{ Vdc}$, $I_E = 0$)	I_{CBO}	–	100	nAdc
ON CHARACTERISTICS				
DC Current Gain ($I_C = 5.0\text{ mA}$, $V_{CE} = 10\text{ Vdc}$)	h_{FE}	40	400	–
Collector–Emitter Saturation Voltage ($I_C = 10\text{ mA}$, $I_B = 1.0\text{ mA}$)	$V_{CE(sat)}$	–	0.25	Vdc
SMALL–SIGNAL CHARACTERISTICS				
Current–Gain – Bandwidth Product ($I_C = 5.0\text{ mA}$, $V_{CE} = 10\text{ Vdc}$, $f = 100\text{ MHz}$)	f_T	125	–	MHz
Output Capacitance ($V_{CB} = 10\text{ Vdc}$, $I_E = 0$, $f = 1.0\text{ MHz}$)	C_{obo}	–	4.0	pF

EQUIVALENT SWITCHING TIME TEST CIRCUITS

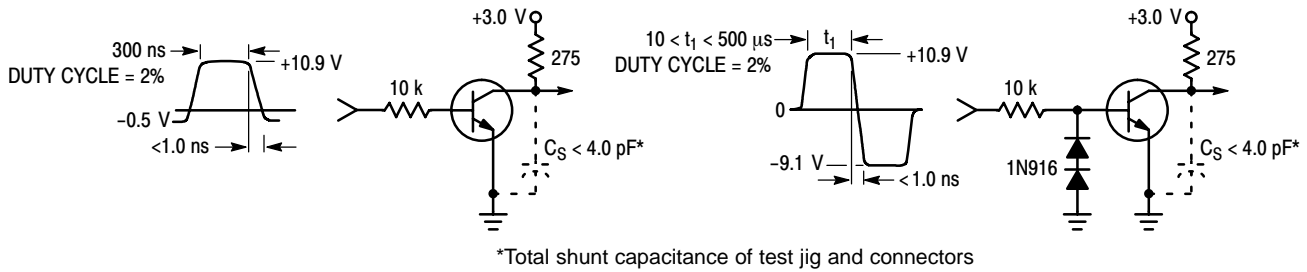

Figure 1. Turn–On Time

Figure 2. Turn–Off Time

MMBTA20LT1

TYPICAL NOISE CHARACTERISTICS

($V_{CE} = 5.0 \text{ Vdc}$, $T_A = 25^\circ\text{C}$)

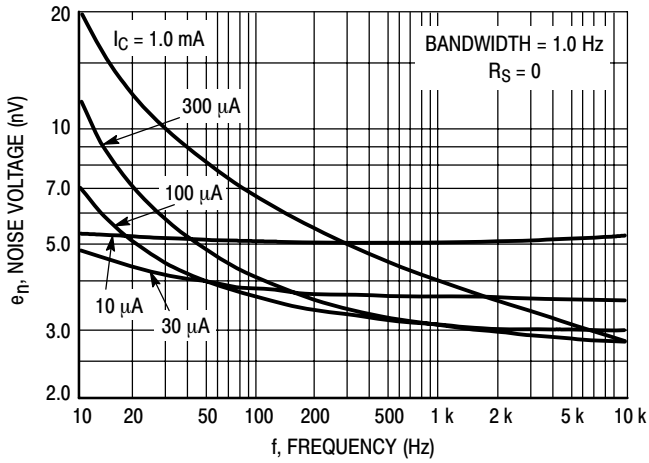

Figure 3. Noise Voltage

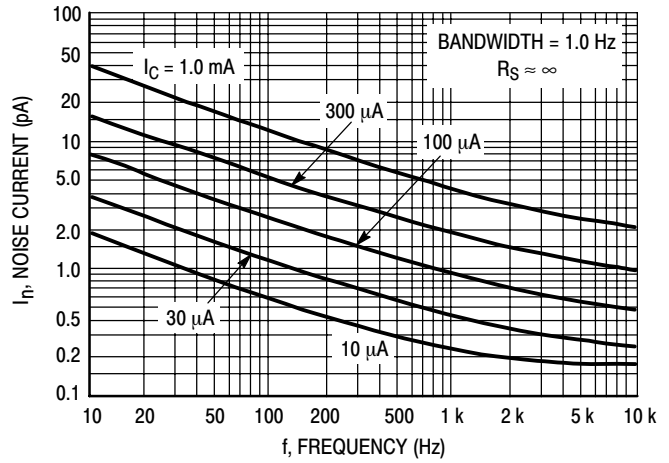

Figure 4. Noise Current

NOISE FIGURE CONTOURS

($V_{CE} = 5.0 \text{ Vdc}$, $T_A = 25^\circ\text{C}$)

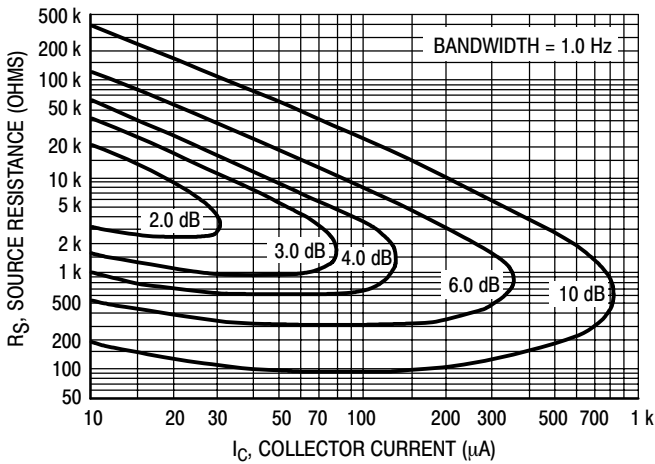

Figure 5. Narrow Band, 100 Hz

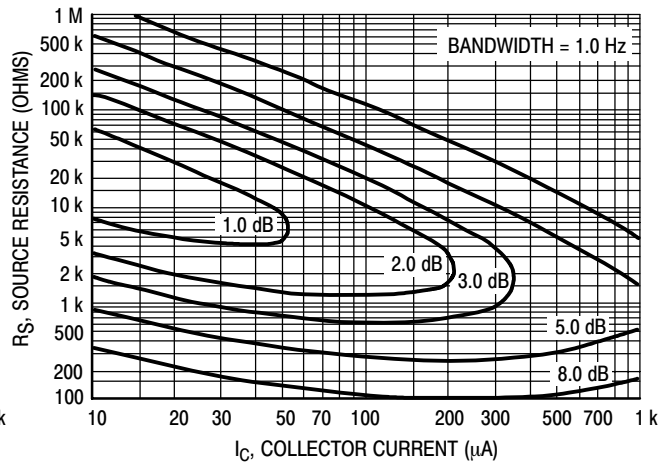

Figure 6. Narrow Band, 1.0 kHz

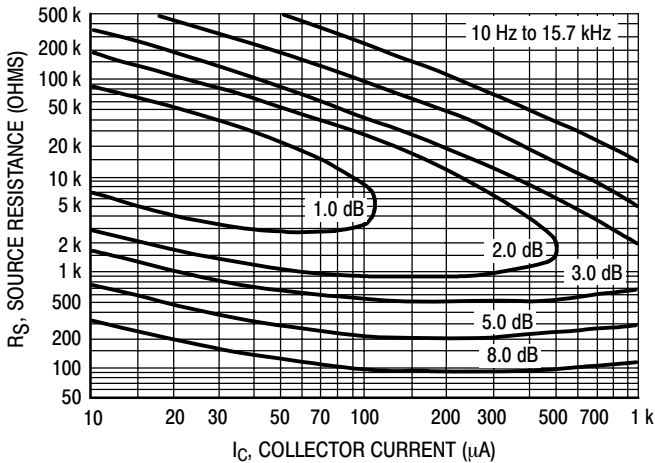

Figure 7. Wideband

Noise Figure is defined as:

$$NF = 20 \log_{10} \left(\frac{e_n^2 + 4KTR_S + I_n^2 R_S^2}{4KTR_S} \right)^{1/2}$$

e_n = Noise Voltage of the Transistor referred to the input. (Figure 3)

I_n = Noise Current of the Transistor referred to the input. (Figure 4)

K = Boltzman's Constant ($1.38 \times 10^{-23} \text{ J}^\circ\text{K}$)

T = Temperature of the Source Resistance ($^\circ\text{K}$)

R_S = Source Resistance (Ohms)

MMBTA20LT1

TYPICAL STATIC CHARACTERISTICS

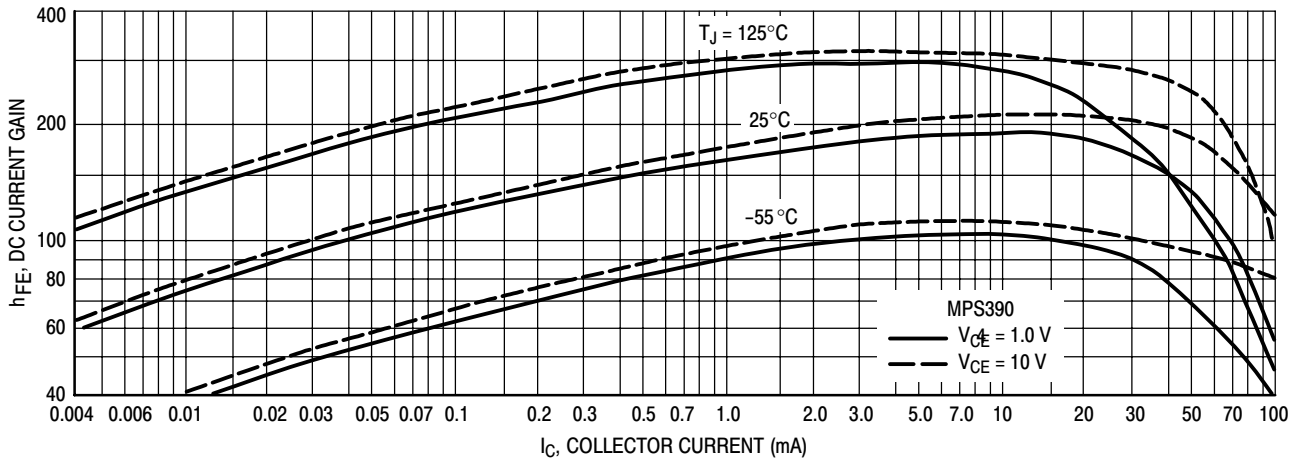

Figure 8. DC Current Gain

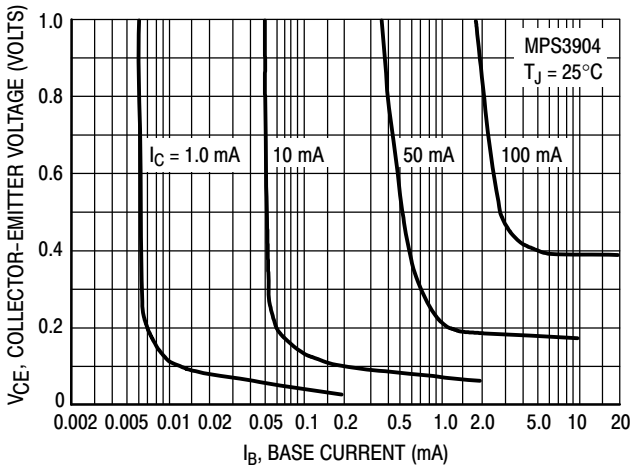

Figure 9. Collector Saturation Region

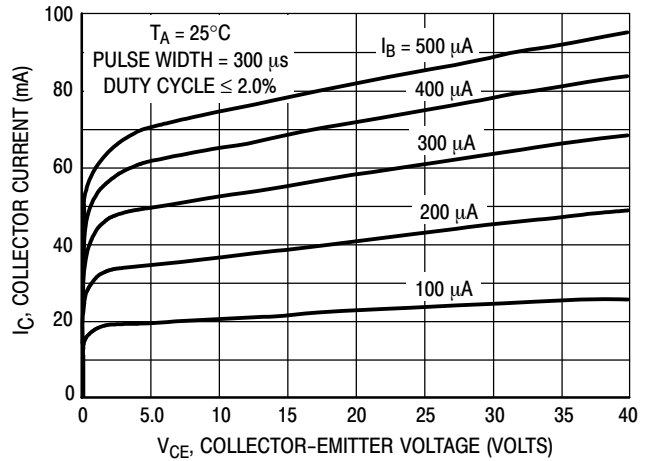

Figure 10. Collector Characteristics

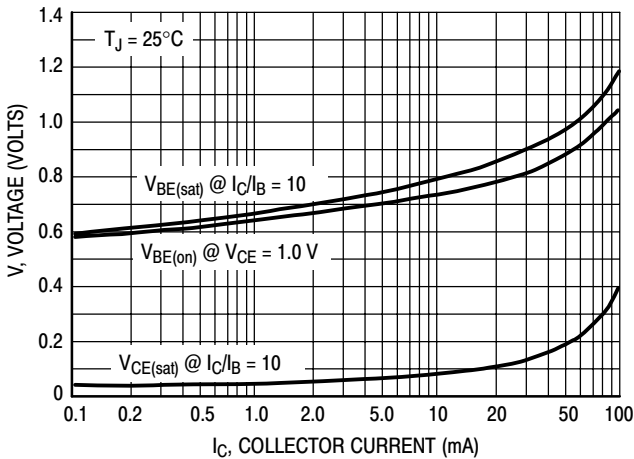

Figure 11. "On" Voltages

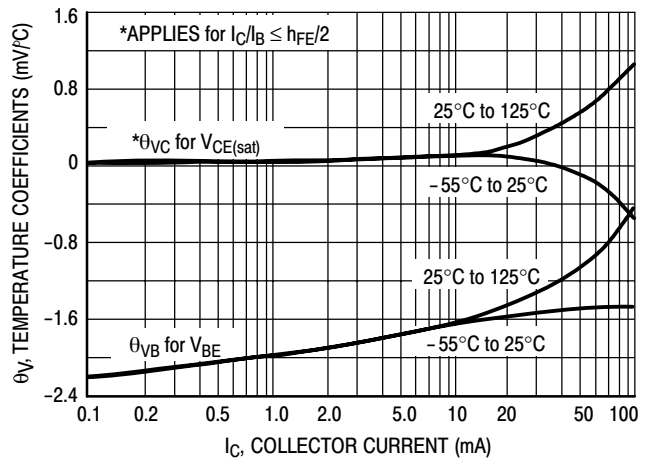

Figure 12. Temperature Coefficients

MMBTA20LT1

TYPICAL DYNAMIC CHARACTERISTICS

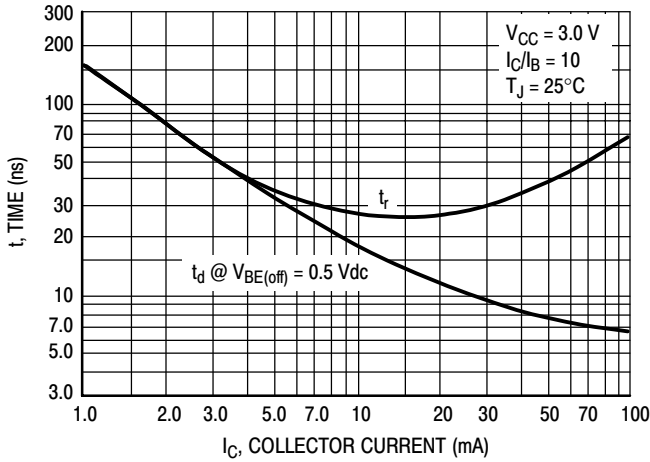

Figure 13. Turn-On Time

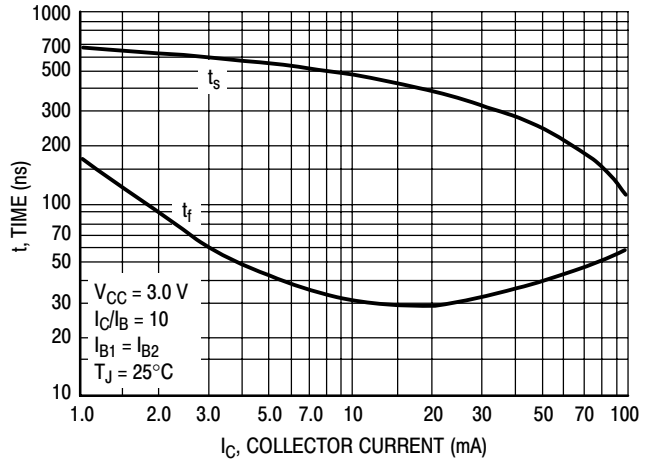

Figure 14. Turn-Off Time

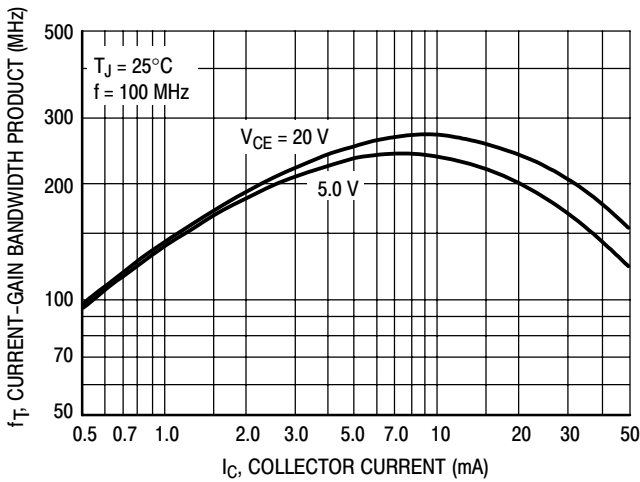

Figure 15. Current-Gain — Bandwidth Product

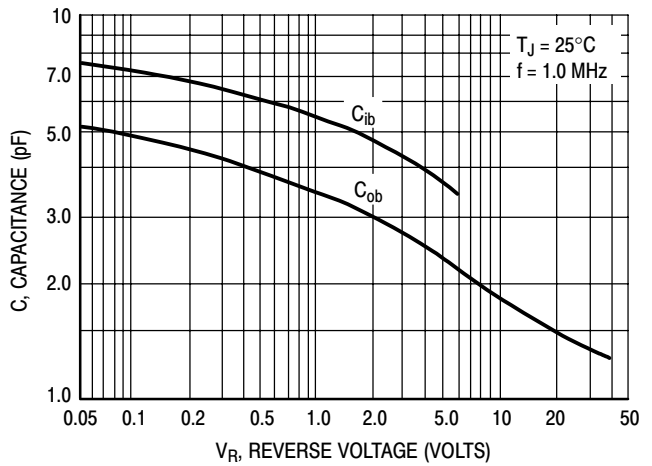

Figure 16. Capacitance

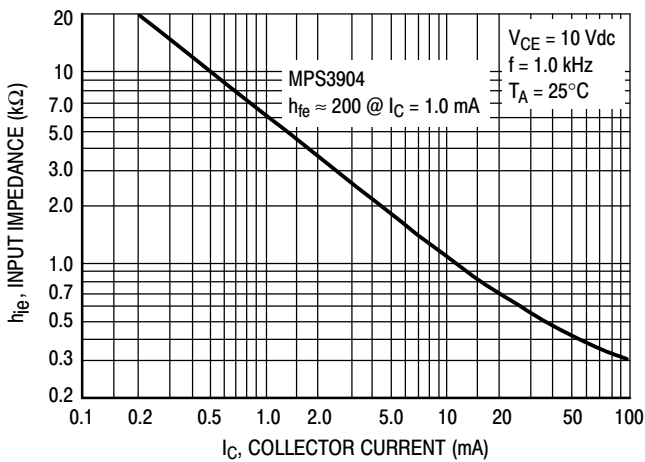

Figure 17. Input Impedance

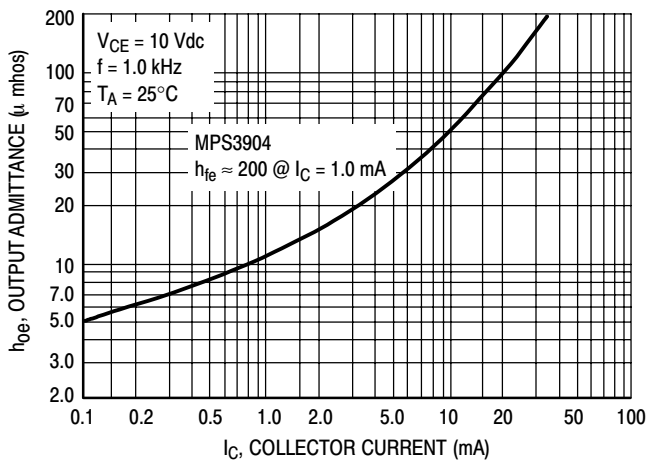

Figure 18. Output Admittance

MMBTA20LT1

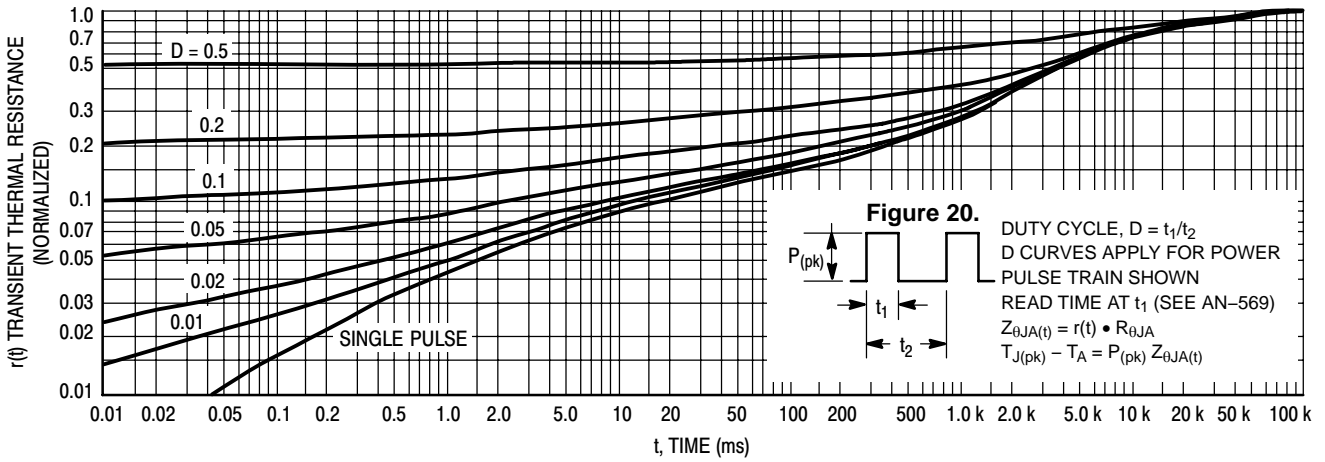

Figure 19. Thermal Response

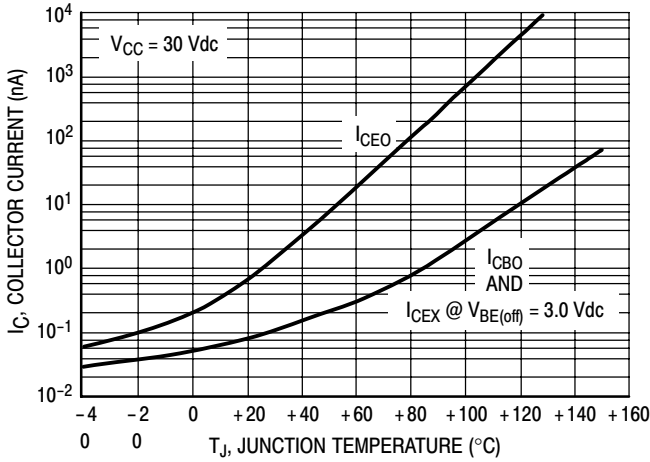

Figure 21.

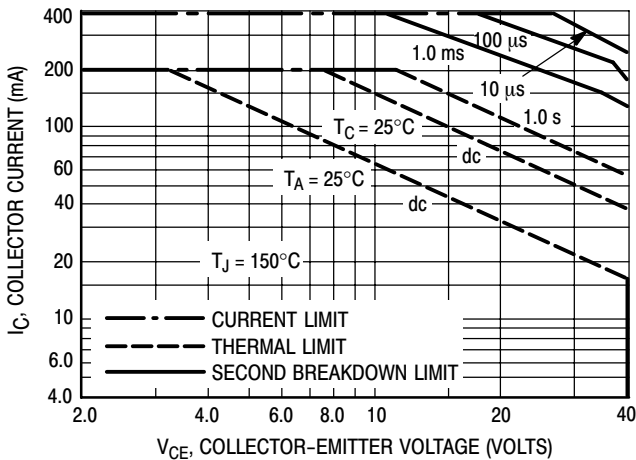

Figure 22.

DESIGN NOTE: USE OF THERMAL RESPONSE DATA

A train of periodical power pulses can be represented by the model as shown in Figure 20. Using the model and the device thermal response the normalized effective transient thermal resistance of Figure 19 was calculated for various duty cycles.

To find $Z_{\theta JA(t)}$, multiply the value obtained from Figure 19 by the steady state value $R_{\theta JA}$.

Example:

The MPS3904 is dissipating 2.0 watts peak under the following conditions:

$$t_1 = 1.0 \text{ ms}, t_2 = 5.0 \text{ ms. (D = 0.2)}$$

Using Figure 19 at a pulse width of 1.0 ms and $D = 0.2$, the reading of $r(t)$ is 0.22.

The peak rise in junction temperature is therefore

$$\Delta T = r(t) \times P_{(pk)} \times R_{\theta JA} = 0.22 \times 2.0 \times 200 = 88^\circ\text{C}.$$

For more information, see AN-569.

The safe operating area curves indicate $I_C - V_{CE}$ limits of the transistor that must be observed for reliable operation. Collector load lines for specific circuits must fall below the limits indicated by the applicable curve.

The data of Figure 22 is based upon $T_{J(pk)} = 150^\circ\text{C}$; T_C or T_A is variable depending upon conditions. Pulse curves are valid for duty cycles to 10% provided $T_{J(pk)} \leq 150^\circ\text{C}$. $T_{J(pk)}$ may be calculated from the data in Figure 19. At high case or ambient temperatures, thermal limitations will reduce the power that can be handled to values less than the limitations imposed by second breakdown.

MMBTA20LT1

PACKAGE DIMENSIONS

SOT-23 (TO-236)
CASE 318-08
ISSUE AN

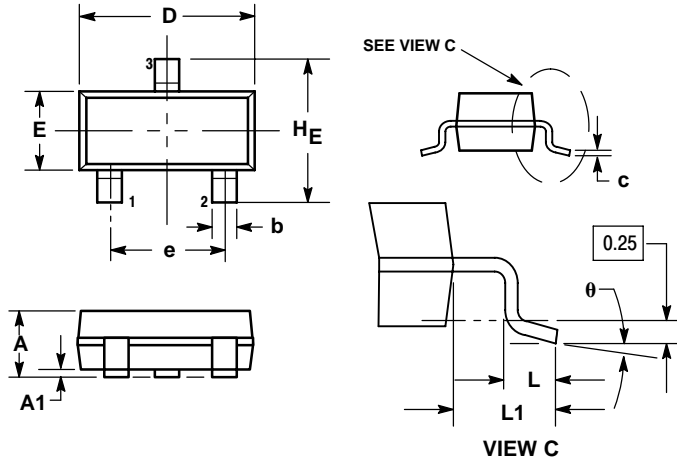

NOTES:

1. DIMENSIONING AND TOLERANCING PER ANSI Y14.5M, 1982.
2. CONTROLLING DIMENSION: INCH.
3. MAXIMUM LEAD THICKNESS INCLUDES LEAD FINISH THICKNESS. MINIMUM LEAD THICKNESS IS THE MINIMUM THICKNESS OF BASE MATERIAL.
4. 318-01 THRU -07 AND -09 OBSOLETE, NEW STANDARD 318-08.

DIM	MILLIMETERS			INCHES		
	MIN	NOM	MAX	MIN	NOM	MAX
A	0.89	1.00	1.11	0.035	0.040	0.044
A1	0.01	0.06	0.10	0.001	0.002	0.004
b	0.37	0.44	0.50	0.015	0.018	0.020
c	0.09	0.13	0.18	0.003	0.005	0.007
D	2.80	2.90	3.04	0.110	0.114	0.120
E	1.20	1.30	1.40	0.047	0.051	0.055
e	1.78	1.90	2.04	0.070	0.075	0.081
L	0.10	0.20	0.30	0.004	0.008	0.012
L1	0.35	0.54	0.69	0.014	0.021	0.029
HE	2.10	2.40	2.64	0.083	0.094	0.104

STYLE 6:

1. BASE
2. EMITTER
3. COLLECTOR

SOLDERING FOOTPRINT*

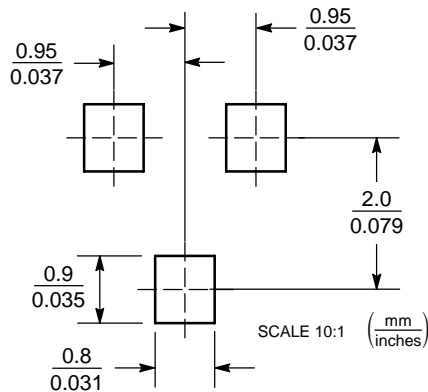

*For additional information on our Pb-Free strategy and soldering details, please download the ON Semiconductor Soldering and Mounting Techniques Reference Manual, SOLDERRM/D.

ON Semiconductor and are registered trademarks of Semiconductor Components Industries, LLC (SCILLC). SCILLC reserves the right to make changes without further notice to any products herein. SCILLC makes no warranty, representation or guarantee regarding the suitability of its products for any particular purpose, nor does SCILLC assume any liability arising out of the application or use of any product or circuit, and specifically disclaims any and all liability, including without limitation special, consequential or incidental damages. "Typical" parameters which may be provided in SCILLC data sheets and/or specifications can and do vary in different applications and actual performance may vary over time. All operating parameters, including "Typicals" must be validated for each customer application by customer's technical experts. SCILLC does not convey any license under its patent rights nor the rights of others. SCILLC products are not designed, intended, or authorized for use as components in systems intended for surgical implant into the body, or other applications intended to support or sustain life, or for any other application in which the failure of the SCILLC product could create a situation where personal injury or death may occur. Should Buyer purchase or use SCILLC products for any such unintended or unauthorized application, Buyer shall indemnify and hold SCILLC and its officers, employees, subsidiaries, affiliates, and distributors harmless against all claims, costs, damages, and expenses, and reasonable attorney fees arising out of, directly or indirectly, any claim of personal injury or death associated with such unintended or unauthorized use, even if such claim alleges that SCILLC was negligent regarding the design or manufacture of the part. SCILLC is an Equal Opportunity/Affirmative Action Employer. This literature is subject to all applicable copyright laws and is not for resale in any manner.

PUBLICATION ORDERING INFORMATION

LITERATURE FULFILLMENT:

Literature Distribution Center for ON Semiconductor
P.O. Box 61312, Phoenix, Arizona 85082-1312 USA
Phone: 480-829-7710 or 800-344-3860 Toll Free USA/Canada
Fax: 480-829-7709 or 800-344-3867 Toll Free USA/Canada
Email: orderlit@onsemi.com

N. American Technical Support: 800-282-9855 Toll Free
USA/Canada

Japan: ON Semiconductor, Japan Customer Focus Center
2-9-1 Kamimeguro, Meguro-ku, Tokyo, Japan 153-0051
Phone: 81-3-5773-3850

ON Semiconductor Website: <http://onsemi.com>

Order Literature: <http://www.onsemi.com/litorder>

For additional information, please contact your local Sales Representative.