

## MMBTA42-G (NPN) RoHS Device

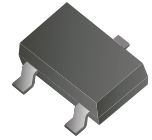

### Features

- High breakdown voltage.
- Low collector-emitter saturation voltage.
- Ultra small surface mount package.

### Diagram:

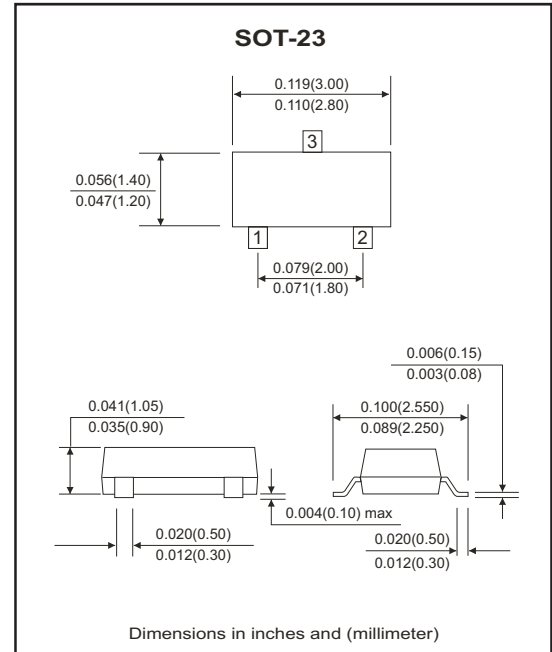
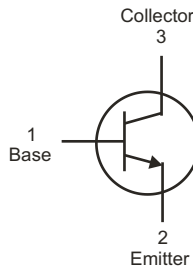

### Maximum Ratings (at $T_A=25^{\circ}\text{C}$ unless otherwise noted)

Parameter	Symbol	Value	Unit
Collector-Base voltage	$V_{CBO}$	300	V
Collector-Emitter voltage	$V_{CEO}$	300	V
Emitter-Base voltage	$V_{EBO}$	5	V
Collector current-Continuous	$I_C$	300	mA
Collector current-peak	$I_{CM}$	500	mA
Collector power dissipation	$P_C$	350	mW
Thermal resistance, junction to ambient	$R_{\theta JA}$	357	$^{\circ}\text{C}/\text{W}$
Junction temperature	$T_J$	150	$^{\circ}\text{C}$
Storage temperature	$T_{STG}$	-55 to +150	$^{\circ}\text{C}$

### Electrical Characteristics (at $T_A=25^{\circ}\text{C}$ , unless otherwise specified)

Parameter	Conditions	Symbol	Min	Max	Unit
Collector-base breakdown voltage	$I_C=100\mu\text{A}, I_E=0$	$V_{(BR)CBO}$	300		V
Collector-emitter breakdown voltage	$I_C=1\text{mA}, I_B=0$	$V_{(BR)CEO}$	300		V
Emitter-base breakdown voltage	$I_E=100\mu\text{A}, I_C=0$	$V_{(BR)EBO}$	5		V
Collector cut-off current	$V_{CB}=200\text{V}, I_E=0$	$I_{CBO}$		0.25	$\mu\text{A}$
Emitter cut-off current	$V_{EB}=5\text{V}, I_C=0$	$I_{EBO}$		0.1	$\mu\text{A}$
DC current gain	$V_{CE}=10\text{V}, I_C=1\text{mA}$	$h_{FE(1)}$	60		
	$V_{CE}=10\text{V}, I_C=10\text{mA}$	$h_{FE(2)}$	100	200	
	$V_{CE}=10\text{V}, I_C=30\text{mA}$	$h_{FE(3)}$	60		
Collector-emitter saturation voltage	$I_C=20\text{mA}, I_B=2\text{mA}$	$V_{CE(sat)}$		0.2	V
Base-emitter saturation voltage	$I_C=20\text{mA}, I_B=2\text{mA}$	$V_{BE(sat)}$		0.9	V
Transition frequency	$V_{CE}=20\text{V}, I_C=10\text{mA}$ $f=30\text{MHz}$	$f_T$	50		MHz

## RATING AND CHARACTERISTIC CURVES (MMBTA42-G)

Fig.1-  $I_c - V_{CE}$

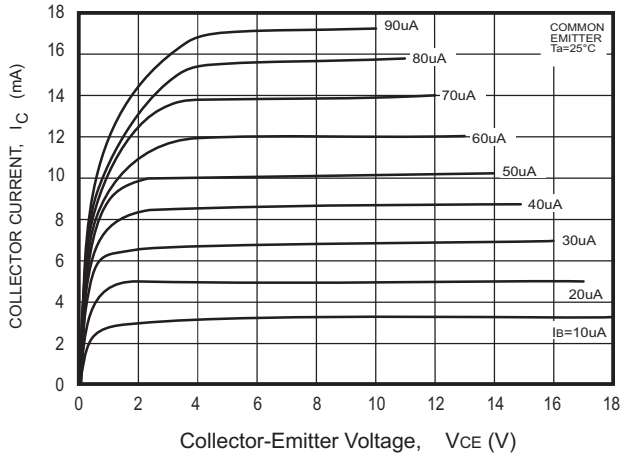

Fig.2-  $h_{FE} - I_c$

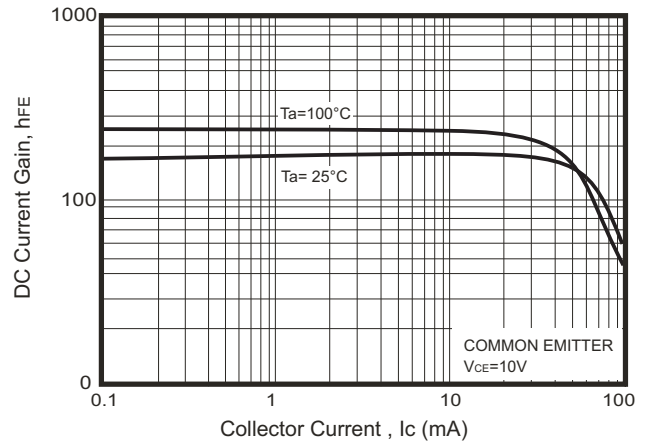

Fig.3-  $V_{CEsat} - I_c$

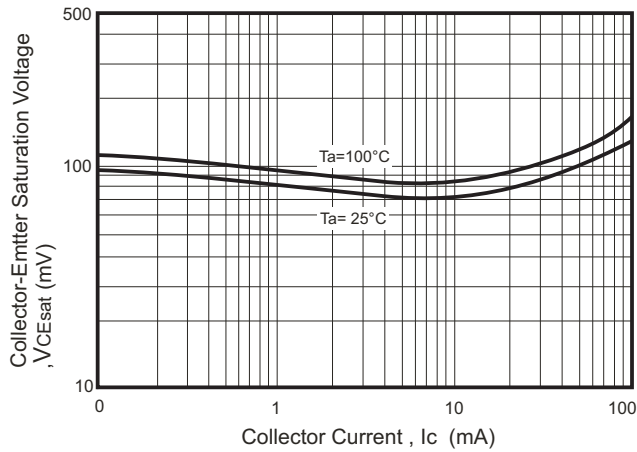

Fig.4-  $V_{BEsat} - I_c$

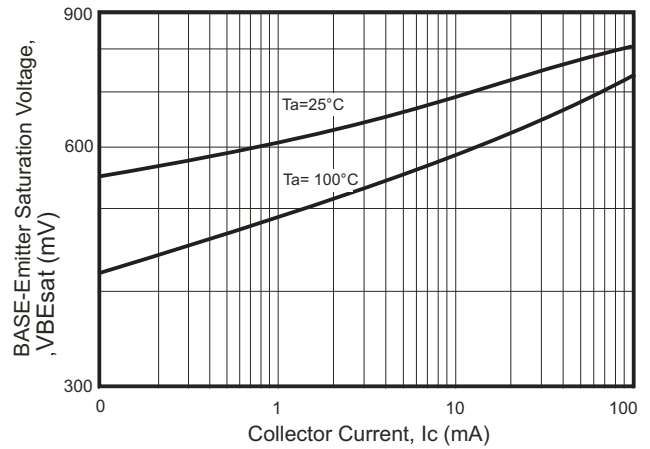

Fig.5-  $I_c - V_{BE}$

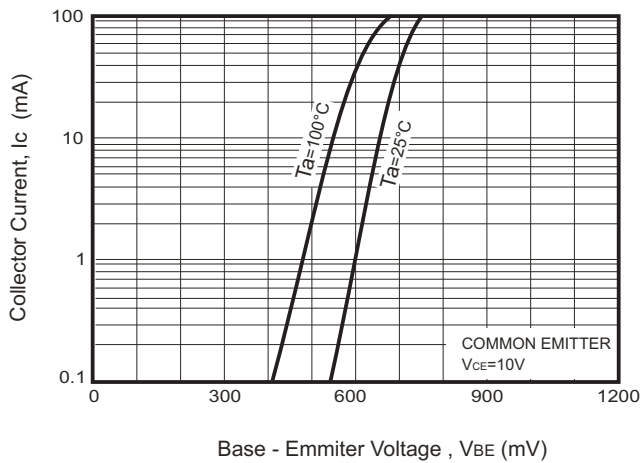
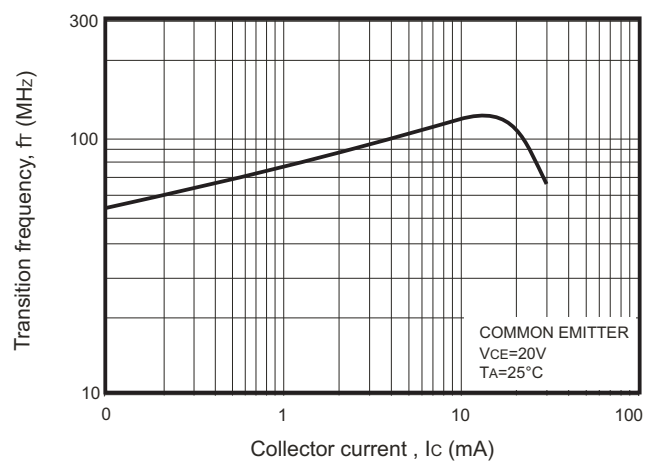

Fig.6-  $f_T - I_c$



## RATING AND CHARACTERISTIC CURVES (MMBTA42-G)

Fig. 7-  $C_{ob}/C_{ib} - V_{CB}/V_{EB}$

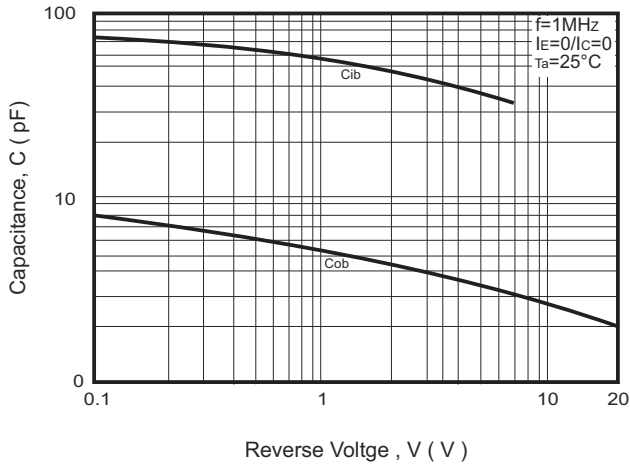
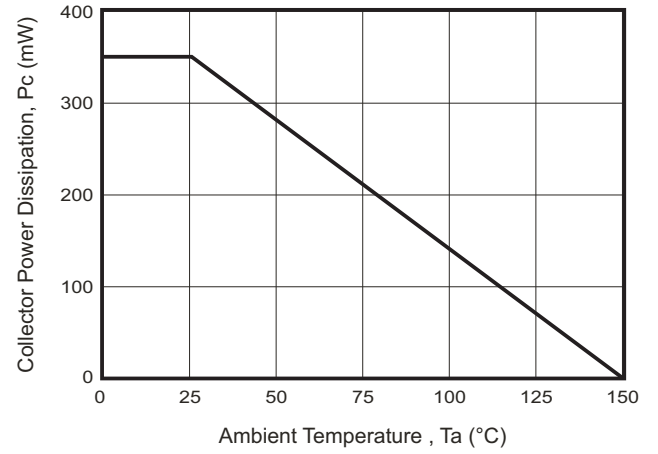
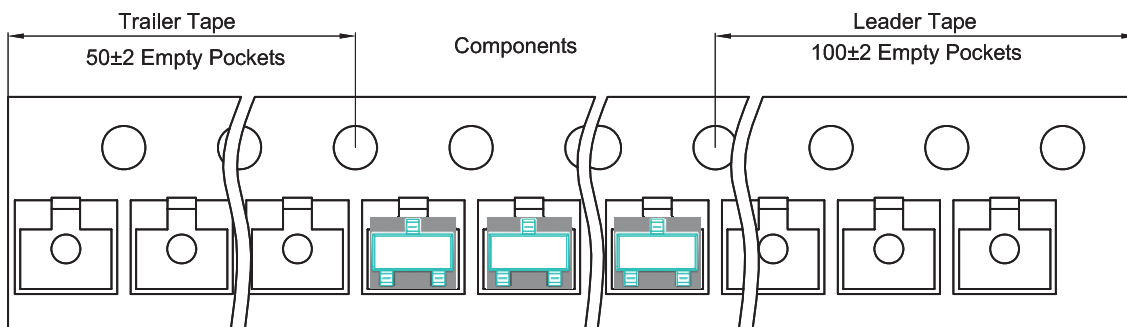
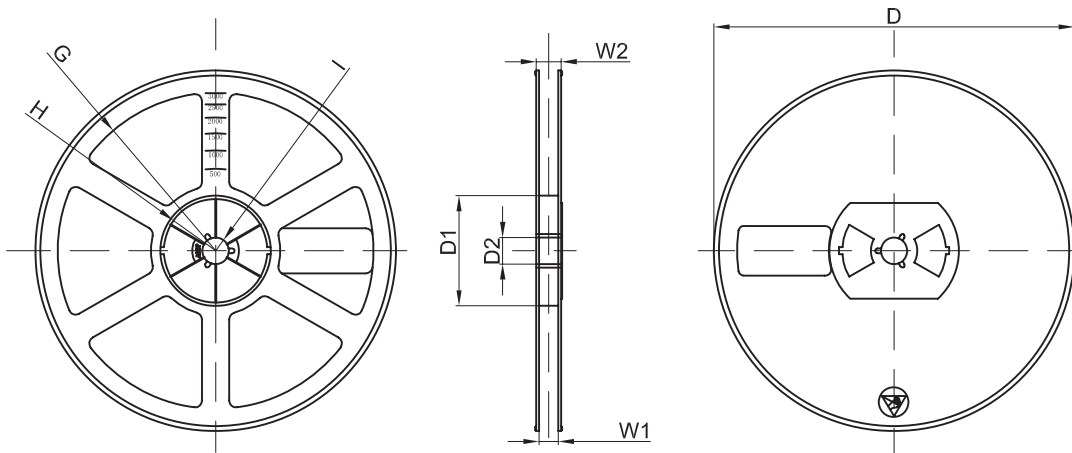
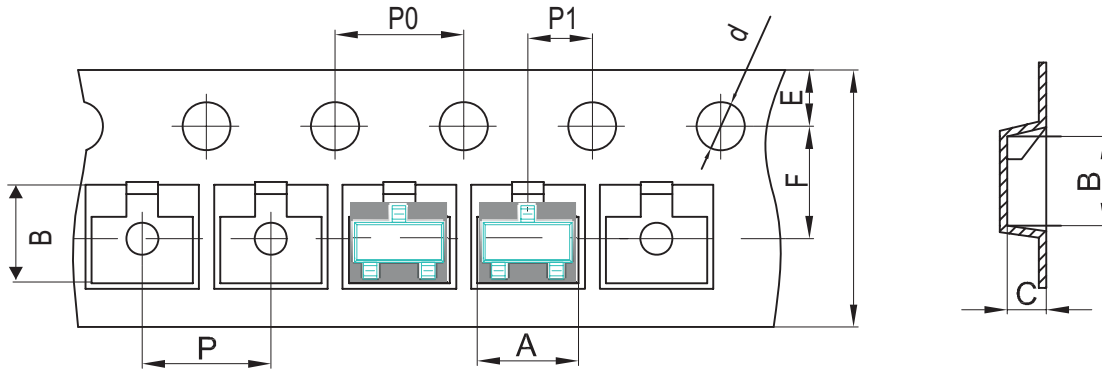

Fig. 8-  $P_c - T_a$



## Reel Taping Specification



SOT-23	SYMBOL	A	B	C	d	D	D1	D2
	(mm)	3.15 ± 0.10	2.77 ± 0.10	1.22 ± 0.10	1.50 ± 0.10	178 ± 2.00	54.40 ± 1.00	13.00 ± 1.00
	(inch)	0.124 ± 0.004	0.109 ± 0.004	0.048 ± 0.004	0.059 ± 0.004	7.008 ± 0.079	2.142 ± 0.039	0.512 ± 0.039

SOT-23	SYMBOL	E	F	P	P0	P1	W	W1
	(mm)	1.75 ± 0.10	3.50 ± 0.10	4.00 ± 0.10	4.00 ± 0.10	2.00 ± 0.10	8.00 + 0.30 / - 0.10	9.50 ± 1.00
	(inch)	0.069 ± 0.004	0.138 ± 0.004	0.157 ± 0.004	0.157 ± 0.004	0.079 ± 0.004	0.315 + 0.012 / - 0.004	0.374 ± 0.039

## Marking Code

Part Number	Marking Code
MMBTA42-G	1D

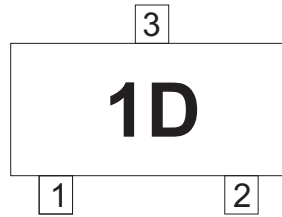

## Suggested PAD Layout

SIZE	SOT-23	
	(mm)	(inch)
A	0.80	0.031
B	1.90	0.075
C	2.02	0.080
D	2.82	0.111

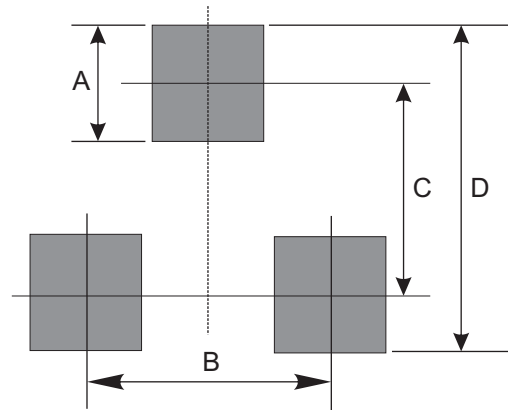

## Standard Packaging

Case Type	Qty Per Reel	Reel Size
	(Pcs)	(inch)
SOT-23	3,000	7